



Study on Greening Cloud Computing and Electronic Communications Services and Networks

Towards Climate Neutrality by 2050

FINAL STUDY REPORT

Valentijn Bilsen
Jens Gröger
Willem Devriendt
Ran Liu
Simonas Gaušas
Felix Behrens
Federico Bley
Marieke Carpentier
Vincent Duchêne
Andreas R. Köhler
Cathy Lecocq
Emma Legein
Dietlinde Quack



VISIONARY
ANALYTICS

Internal identification

Contract number: LC-01568995

VIGIE number: 2020-652

EUROPEAN COMMISSION

Directorate-General for Communications Networks, Content and Technology

Directorate E — Future Networks

Unit E2 — Cloud and Software

Contact: CNECT-E2@ec.europa.eu

*European Commission
B-1049 Brussels*

Study on Greening Cloud Computing and Electronic Communications Services and Networks

Towards Climate Neutrality by 2050

FINAL STUDY REPORT

**EUROPE DIRECT is a service to help you find answers
to your questions about the European Union**

Freephone number (*):
00 800 6 7 8 9 10 11

(*) The information given is free, as are most calls (though some operators, phone boxes or hotels may charge you)

LEGAL NOTICE

This document has been prepared for the European Commission however it reflects the views only of the authors, and the European Commission is not liable for any consequence stemming from the reuse of this publication. The Commission does not guarantee the accuracy of the data included in this study. More information on the European Union is available on the Internet (<http://www.europa.eu>).

PDF	ISBN 978-92-76-46887-5	doi:10.2759/116715	KK-06-22-043-EN-N
-----	------------------------	--------------------	-------------------

Manuscript completed in November 2021

1st edition

The European Commission is not liable for any consequence stemming from the reuse of this publication.

Luxembourg: Publications Office of the European Union, 2022

© European Union, 2022



The reuse policy of European Commission documents is implemented by the Commission Decision 2011/833/EU of 12 December 2011 on the reuse of Commission documents (OJ L 330, 14.12.2011, p. 39). Except otherwise noted, the reuse of this document is authorised under a Creative Commons Attribution 4.0 International (CC-BY 4.0) licence (<https://creativecommons.org/licenses/by/4.0/>). This means that reuse is allowed provided appropriate credit is given and any changes are indicated.

For any use or reproduction of elements that are not owned by the European Union, permission may need to be sought directly from the respective rightholders.

Contents

Contents	5
Tables	8
Figures	11
Boxes	13
Abstract	14
Abstrait	15
Executive Summary	16
Context	16
Objectives of the study	16
Methodology	17
Policy measures for increasing energy and resource efficiency of greening data centres and cloud computing	17
Policy options for a transparency mechanism on the environmental footprint of ECNs and ECSs.....	20
Deployment of new network components	21
Transparency towards customers in the delivery of telecommunication services	21
The need for minimum efficiency and Ecodesign requirements	22
Résumé	23
Contexte.....	23
Objectifs de l'étude.....	23
Méthodologie	24
Mesures politiques visant à accroître l'efficacité énergétique et l'efficacité des ressources des datacenters écologiques et de cloud computing	24
Options politiques pour un mécanisme de transparence sur l'empreinte environnementale des réseaux et services de télécommunication.....	28
Déploiement de nouveaux composants de réseau	28
Transparence envers les clients-consommateurs dans la prestation des services de télécommunication.....	29
La nécessité de respecter des exigences minimales en matière d'efficacité et d'écoconception	29
1. Introduction, background and objectives	31
1.1 The digital transformation and increased policy attention towards energy efficiency and circular economy.....	31
Total energy demand and carbon footprint	31
Energy efficiency	33

Resource efficiency.....	34
Existing EU policy initiatives	35
1.2. Measuring circular economy performance of data centres and cloud computing, electronic communications services and networks.....	37
1.3. Objectives of the Study	39
2. Final Results Part 1 – Indicators and Standards	43
2.1. Task 1.1: Indicators and standards: Data Centres and Cloud Computing	43
Task 1.1.1: Propose possible definitions of data centres.....	43
Task 1.1.2: Research current market practices for circularity of data centre hardware.....	71
Task 1.1.3: Research into methods for measuring energy and resource efficiency and recommendation for a harmonised measurement framework	91
2.2. Task 1.2: Indicators and standards: Electronic Communications Services and Networks	111
Task 1.2.1: Current practices of electronic communications network operators and service providers on reporting of their environmental performance	111
Task 1.2.1a: Options for communicating the environmental benefits of products to consumers	127
Task 1.2.2: Current practices on the assessment of the environmental sustainability of new electronic communications networks.....	135
Task 1.2.3: Standards and measurement methodologies for the monitoring of environmental footprint of electronic communications networks and services.	145
Task 1.2.4: Assessment of the suitability of indicators from consumer perspective	158
Task 1.2.5: Criteria for the assessment of the environmental sustainability of new electronic communications networks	174
2.3. Main lessons on indicators and standards for Data Centres and Electronic Communications Services and Networks	182
2.3.1. Main lessons for Data Centres – definitions, market practices and measures	182
2.3.2. Main lessons for Electronic Communications Services and Networks – reporting, assessing, and measuring environmental sustainability.....	187
3. Final Results Part 2 – Policy Options	189
3.1. Goal and operationalisation.....	189
3.1.1. Goal.....	189
3.1.2. Operationalisation: a systematic funnel approach based on intervention logic with focus on the impacts	189
3.2. Task 2.1.1. Policy options for Data Centres and Cloud Computing	191
3.2.1. Description of potential policy options	191
Policy options with a direct impact	193
Policy options with an indirect impact	220

3.3. Task 2.2.1. Policy options for transparency measures for Electronic Communications Services and Networks	227
3.3.1. Description of policy options for ECNs and ECS.....	227
3.3.2. Comparison of the different policy options.....	238
3.3.3. Ranking of policy options for transparency measures for ECNs	241
3.4. Conclusions: towards more energy and resource efficient data centres and options for a transparency mechanism for electronic communications services and networks.....	242
3.4.1. Data centres and cloud computing.....	243
3.4.2. Electronic communications services and networks.....	245
Glossary and list of acronyms.....	248
References	252
Annex 1: Overview interviewed associations and companies	262
Annex 2: Distribution reports of the surveys.....	263
Annex 3: Interview questions for Data Centre Associations related to Tasks 1.1.1., 1.1.2. and 1.1.3. (version 19-01-2021).....	265
Annex 4: Questions for survey to electronic communications network operators, service providers and network equipment suppliers related to Task 1.2.1 and Task 1.2.2 (version 23-02-2021).....	268
Annex 5: Questions for survey about consumer perspectives on potential indicators for environmental footprint of electronic communications services related to Task 1.2.4 (version 17-05-2021)	272
Annex 6: Task 1.1.3 Methods for measuring energy and resource efficiency of data centres	276
Annex 6.1: Overview of metrics of environmental performance	276
Annex 6.2: Overview of metrics in terms of environmental performance and general IT-performance metrics combined	287
Annex 6.3: Overview of metrics in terms of environmental performance and useful IT-Performance combined: productivity proxy metrics.....	289
Annex 7: Task 1.2.1 References to telecom operators' online public communication of green claims...298	
Annex 8: Task 1.2.3 Standards and measurement methodologies for the monitoring of environmental footprint of electronic communications networks and services	300
Annex 9: The policy intervention logic.....	339

Tables

Table 1: Objectives in the subsequent tasks ordered by ICT value chain segment and part in the study process	42
Table 2: Uptime tier requirements summary	53
Table 3: General principle of availability typologies	53
Table 4: Size classes of data centres according to the US Data Center Energy Usage Report	55
Table 5: Size thresholds used to categorise data centres – DC interview results	58
Table 6: Size thresholds used to categorise data centres – DC survey results	58
Table 7: Market share of European data centres by purpose (in white space, and in number)	63
Table 8: Application matrix for analysing ownership and operation across layers of DCs	70
Table 9: Criteria and thresholds for dividing data centres according to size class (small, large, hyperscale)	71
Table 10: Main components of a data centre facility (Garnier, 2012)	74
Table 11: Certifications and standards for data centres' circularity practices related to hardware, applicable in Europe	76
Table 12: The 10R framework for guiding and identifying potential policy suggestions for increasing data centre hardware circularity	79
Table 13: Reuse rate and reusability index of data server components	86
Table 14: Overview of metrics classification based on literature	92
Table 15: Colour code for classifying metrics	96
Table 16: Overview of 71 selected metrics and 6 DC-relevant labelling or certification scheme	98
Table 17: Number of metrics based on different perspectives	99
Table 18: ISO/IEC standards concerning energy and resource relevant metrics of DCs	101
Table 19: Metrics required in the DCMM	102
Table 20: ITU and ETSI energy relevant metrics concerning DCs	103
Table 21: Metrics considered in Green Data Centre (GDC) Assessment Toolkit by the CATALYST project	104

Table 22: Data centre labelling or certifications	105
Table 23: Requirements of environmental reporting schemes applicable to the telecommunications sector	117
Table 24: Environmental aspects covered by reporting schemes applicable to the telecommunications sector	118
Table 25: Evaluation of the reporting schemes	119
Table 26: Which electronic communications services do you mainly offer?	123
Table 27: How does your company report on its environmental policies and impacts?	124
Table 28: Which areas of the company's activities are included in this reporting? ...	125
Table 29: Which indicators do you use for environmental reporting?	125
Table 30: What standards do you use for company-wide reporting?	126
Table 31: What key-figures does your company communicate to consumers (e.g. advertising, product data sheets) when reporting the environmental performance of communications services?	127
Table 32: Methods for measuring the ICT footprint of organisations, products and services	136
Table 33: What requirements do you expect suppliers to meet when you procure new network equipment? What are your requirements when you offer network components?	143
Table 34: Power consumption of network components along a 2.2 Mbps data stream (in %)	148
Table 35: Overview of specific ECN-relevant ITU and ETSI methodologies	152
Table 36: Description of metrics applied in ITU and ETSI methodologies	154
Table 37: Overview of expected main potential impacts for CoC policy options	202
Table 38: Recent revisions of EU GPP criteria in the field of the ICT sector	205
Table 39: Overview of expected main impacts and transition mechanisms for mandatory EU GPP criteria	209
Table 40: Overview of expected main impacts and transition mechanisms for stricter requirements in the Ecodesign Regulation on servers and data storage products ...	212
Table 41: Overview of expected main impacts and transition mechanisms for the application of the SFT Delegated Act	216
Table 42: Overview of expected main impacts and transition mechanisms for the application of a DC sector self-regulation initiative	217

Table 43: Overview of expected main impacts and transition mechanisms for the application of a European Data Centre Registry	219
Table 44: Overview of expected main impacts and transition mechanisms for policy measures that are indirectly related to data centres.....	224
Table 45: Policy options for enhancing the efficiency of ECNs.....	238
Table 46: Overview of metrics in terms of power and energy, sorted by the field of application	276
Table 47: Overview of metrics in terms of natural resource.....	282
Table 48: Overview of metrics in terms of water.....	282
Table 49: Overview of metrics in terms of wastes (e.g. e-waste, waste heat), sorted by the field of application.....	283
Table 50: Overview of metrics in terms of environmental impacts (in this case: CO ₂ -eq), sorted by the field of application	285
Table 51: Relevant general IT- performance metrics	287
Table 52: Overview of metrics in terms of environmental performance and general IT- performance metrics combined	288
Table 53: Productivity proxy metrics	289
Table 54: List of ECN-relevant standards and methodologies from the ITU and ETSI considered	300

Figures

Figure 1: Global data centre energy demand by data centre type, 2010-2022.....	32
Figure 2: Global estimated carbon footprint related to energy consumption (in Gt CO ₂), 2020-2030.....	33
Figure 3: Global hyperscale operators' capital expenditure (CAPEX) (in billion euros)	34
Figure 4: Electronic waste generated worldwide from 2010 to 2019.....	35
Figure 5: Methods operators of data centre infrastructure use to measure success worldwide 2019, in Percent	38
Figure 6: Data centre definition overview.....	61
Figure 7: Data Centre Delivery Model worldwide 2018-2019, in %.....	64
Figure 8: Number of data centres by purpose in the DC survey.....	65
Figure 9: Server age distribution, energy consumption and compute capacity	66
Figure 10: End-users of data centres	66
Figure 11: Average annual growth predictions (time horizon: 5 years)	68
Figure 12: Ownership based data centre definition	69
Figure 13: Circular Economy for Data Centre Lifecycle	72
Figure 14: Data centre server refresh cycles, 2015 versus 2020	73
Figure 15: Methods of handling outdated data centre server hardware worldwide 2018-2019, in %	78
Figure 16: Remanufacturing steps of data centre hardware	81
Figure 17: Connecting data centres to a green energy grid for waste heat valorisation (Example for the Netherlands).....	83
Figure 18. Illustration of the relationship between metrics and characteristics of metrics as well as the aspects considered in DCs.....	92
Figure 19: Illustration of the classification of the reporting schemes.....	116
Figure 20: Scope of the ECN to be covered in dotted lines.....	145
Figure 21: Categorisation of networks differing technology generations and network segments	146
Figure 22: Global energy consumption by category of WAN.....	147

Figure 23: Electricity consumption of global networks including manufacturing and operation	149
Figure 24: Useful work concept for ICT based on ITU T-L 1315 and ETSI ES 203 475: Standardization terms and trends in energy efficiency	157
Figure 25: Policy mix for more sustainable products	159
Figure 26: Example for energy efficiency label for access network	165
Figure 27: Do you consider information to consumers on the environmental footprint of electronic communications services to be an effective way for achieving a reduction in the energy consumption of the electronic communications services?	166
Figure 28: In your opinion, what is the role of the following aspects in consumers' decision to choose a particular electronic communications service (e.g. mobile operator or internet service provider)?	167
Figure 29: To which level should the information on environmental impacts refer? ..	168
Figure 30: How understandable do you think the following environmental indicators on electronic communications services are for consumers?	168
Figure 31: Where should such information on the environmental indicators of communications services be provided?	169
Figure 32: Do you think a colour coded label would help consumers to take energy efficiency into account when deciding on a specific service?	170
Figure 33: What additional information or measures could enhance the effect of such colour coding?	171
Figure 34: Do you see potential disadvantages or risks for consumers if information on environmental footprint of services is introduced?	171
Figure 35: Which instruments do you think could be most suitable to improve the environmental footprint of communication services?	172
Figure 36: Funnel approach for identifying and analysing policy measures and options	190
Figure 37: Conceptualisation of a DC and related policies with direct and indirect impacts	192
Figure 38: Frequency of best practices adopted by data centres participating in the CoC in 2016	198
Figure 39: Generic intervention Logic of a policy option	339

Boxes

Box 1: Linking data centre types to information on energy efficiency and environmental performance	48
Box 2: Facebook business case example for data centre circularity practices.....	82
Box 3 Google business model example for maintenance of IT equipment.....	84
Box 4 Circular Electronics Partnership.....	85
Box 5: Example of IBM Tape storage innovation	87
Box 6: The Climate Neutral Data Center Pact: an example of a Self-Regulatory initiative	89
Box 7: Reference units in the formation of key figures (e.g. subscribers or service units)	163
Box 8: Workshop feedback on quantitative energy efficiency goals in the CoC.....	197
Box 9: Workshop feedback on introducing a tier-system label indicating the adoption rate of best practices in the CoC.....	199
Box 10: Workshop feedback on third-party monitoring obligation for participants in the CoC	200
Box 11: Workshop feedback on tools to increase participation in the CoC.....	201
Box 12: Workshop feedback on mandatory GPP criteria.....	210
Box 13: Workshop feedback on stricter requirements for servers and data storage products in the Ecodesign Regulation	212
Box 14: Workshop feedback on the application of the EU Taxonomy and Climate Delegated Act	216
Box 15: Workshop feedback on a DC sector self-regulation initiative.....	218
Box 16: Workshop feedback on a European Data Centre Registry	220
Box 17: General feedback on the proposed metrics	228
Box 18: Feedback on an ECN energy register.....	230
Box 19: Feedback on a Code of Conduct	232
Box 20: Feedback on a topten product database	233
Box 21: Feedback on an energy efficiency –type of label	235
Box 22: Feedback on an Eco-Label	237

Abstract

The current rapid digital transformation is characterized by an increase in the generation, use and transmission of data, and IT infrastructure, which in turn leads to an increased energy and resource consumption. Therefore in view of the EU Green Deal and related policy strategies, the digital transformation also requires a green transformation.

Therefore the broad objectives of this study are to propose i) policy measures for increasing the energy and resource efficiency of data centres as well as ii) policy options that could be included in a transparency mechanism on the environmental footprint of electronic communications services and networks (ECNs) and criteria for environmental sustainability assessments. A dual research strategy was followed, focussing on data centres and cloud computing on the one hand and ECNs on the other hand.

For data centres the study proposes primarily (a combination of) the following policy measures:

- Improvements to the Code of Conduct;
- Compulsory green public procurement criteria for publicly procured data centres, server rooms and cloud services; and
- The set-up of a European Data Centre Registry.

Concerning ECNs, the two main propositions are:

- The deployment of a energy efficient network infrastructure;
- The provision of eco-friendly telecommunications services by ECN operators.

Abstrait

La transformation numérique rapide actuelle se caractérise par une augmentation de la production, de l'utilisation et de la transmission de données, ainsi que de l'infrastructure informatique, ce qui entraîne à son tour une augmentation de la consommation d'énergie et de ressources. C'est pourquoi, dans la perspective du "Green Deal" de l'UE et des stratégies politiques connexes, la transformation numérique nécessite également une transformation verte.

Les objectifs généraux de cette étude sont donc de proposer i) des mesures politiques pour augmenter l'efficacité énergétique et l'efficacité des ressources des centres de données ainsi que ii) des options politiques qui pourraient être incluses dans un mécanisme de transparence sur l'empreinte environnementale des services et réseaux de communications électroniques (ECN) et des critères pour les évaluations de la durabilité environnementale. Une double stratégie de recherche a été appliquée, se concentrant sur les centres de données et l'informatique en nuage d'une part, et sur les ECN d'autre part.

Pour les centres de données, l'étude propose principalement (une combinaison) des mesures politiques suivantes :

- Des améliorations au code de conduite ;
- Des critères obligatoires de marchés publics écologiques pour les centres de données, les salles de serveurs et les services d'informatique en nuage achetés par les pouvoirs publics ; et
- La création d'un registre européen des centres de données.

Concernant les ECNs, les deux principales propositions sont :

- Le déploiement d'une infrastructure de réseau économe en énergie ;
- La fourniture de services de télécommunications écologiques par les opérateurs ECN.

Executive Summary

Context

The current rapid digital transformation is characterized by an increase in the amount of data to be recorded, processed, stored, and transmitted, entailing an increase in IT infrastructure and subsequent energy and resource consumption. This digital trend therefore raises concerns on its environmental impact, especially in the light of the European Green Deal which is aimed at a more digital and environmentally sustainable economy. To enable this twin – digital and green – transition, it will be important to introduce policy measures that enhance energy efficiency and circular economy practices in the ICT value chains. This study aims to inform and propose future policy measures, focusing specifically on cloud computing and data centres (DCs), as well as electronic communications services and networks (ECNs).

Objectives of the study

The objectives of this study can be categorized according to the two main parts of the ICT-value chain that are subject of this study:

Data centres and cloud computing:

1. To propose policy measures for increasing the energy and resource efficiency of data centres and assess the environmental, social and economic impact.
2. In support of that objective to perform:
 - An analysis of data centre definitions and types and determine meaningful size thresholds;
 - An analysis of current market practices related to circularity and identify potential ways to increase circularity;
 - An analysis of standards, metrics, indicators, methods and methodologies that are currently used in the field for assessing energy and resource efficiency and an assessment of their suitability for inclusion in policy measures
 - To identify gaps in the value chains where potential for energy efficiency and/or circularity is lost and potential measures to bridge these gaps;

Electronic communications services and networks:

1. To propose policy options that could be included in a transparency mechanism on the environmental footprint of ECNs and in view of this:
 - To report practices, indicators, standards and methodologies related to the environmental footprint of electronic communications networks and services
 - To report on sustainability aspects of the service offered to consumers (in particular to assess a number of possible indicators in view of end-user communication and for analysing the impact of a voluntary and mandatory transparency mechanism on the environmental footprint of electronic communications services and on relevant stakeholders.
2. To consider criteria for the assessment of the environmental sustainability of new electronic communications networks.

Methodology

In line with the objectives for respectively the data centres, and electronic communications services and networks, a sequential research approach was elaborated focussing first on indicators, practices and standards, and subsequently on the elaboration of policy measures for greening data centres, and policy options for transparency mechanisms for electronic communications services and networks.

Although each of the research topics listed in the objectives has its own approach and specificities, a set of cross-cutting methodologies were applied. First thorough desk research was performed where relevant academic and grey literature was reviewed. In parallel, in-depth interviews were held with top executives of data centres, network operators, cloud service providers, industry associations and experts with the purpose of gaining deeper insight in current market practices related to circularity. Additionally, three surveys were launched, tailored to the two respective target groups: DCs and ECNs/ECSs providers. These surveys provided further input from a total of 124 individual respondents. The interim results were presented and discussed in an online validation workshop and event. The validation workshop for the data centres was held Friday the 4th of June 2021 with representatives from private companies, and national associations from various Member States. The discussion of the intermediate results for the ECNs was held on Friday the 25th of June 2021 with company representatives and a representative from an EU association and 28th June with BEREC (Body of European Regulators for Electronic Communications) ad hoc working group on sustainability.

Policy measures for increasing energy and resource efficiency of greening data centres and cloud computing

On the basis of careful analyses, stakeholder feedback from the surveys, interviews, and more prominently from the online workshop, a number of policy measures can be proposed that are feasible, effective and specifically targeted to data centres and cloud computing. In our view this is a combination of:

- Improvements to the Code of Conduct (from here on referred to as the CoC);
- compulsory green public procurement criteria for publicly procured data centres, server rooms and cloud services; and
- the set-up of a European Data Centre Registry.

Other measures are interesting and useful as well, yet appear to be more focussed on particular aspects of data centres and cloud computing or rather indirectly affecting their energy and resource efficiency.

1. Code of Conduct



2. Green Public Procurement



3. Data Centre Registry



The **Code of Conduct (CoC)** is an important instrument in greening data centres. In this study a number of potential improvements have been assessed. Consultation with the stakeholders indicates that it is important to maintain the best practice approach and that its voluntary nature should be kept. Setting quantitative energy efficiency goals was perceived as challenging due to large regional differences across the EU in terms of climate, access to renewable energy sources and business models. An EU level playing field is key. Nevertheless in our view introducing a widely accepted quantitative energy efficiency target such as the PUE in combination with ranges that reflect differences in regional conditions and a classification of data centres should be feasible. Third-party monitoring is perceived as having a value added provided that the independence of the certifiers and confidentiality of the information can be guaranteed. In view of the perceived benefits of an improved version of the CoC, methods for increasing participation are valuable. Especially initiatives that reach out to SME data centres are welcomed, both to disseminate the expertise to implement the best practices as well as improvements in financing and business model development.

The change from voluntary to **mandatory GPP core criteria** for publicly procured data centres and cloud services would not only have an important signal function from authorities putting action to word in their own areas of operation, but would also foster the greening of data centres and cloud computing services overall. It has to be admitted that the private market segment is much larger. Yet in view of the increasing digitalisation of government services the public sector can create a critical mass and lead the market in the data centre and cloud services segment. As with the CoC, an EU level playing field is important, as well as equal access to the public data centre procurement market for small data centres.

The third most feasible policy measure is creating a **European Data Centre Registry** where energy consumption and material use are transparently reported. The registry can be developed in parallel and in consistency with the CoC improvement and mandatory GPP criteria indicated above. Critical points to be resolved are the treatment of confidential business information, the precise definition of indicators to be provided, and the control and management of the Registry. These are not unsurmountable challenges which can be adequately solved using e.g. a mutually agreed protocol between the data centre operators and the organisation responsible for the Registry. The Registry would be instrumental in monitoring and analysing the progress towards greening data centres, as well as in providing valuable market information for the stakeholders. In combination with the EU Data Centre Registry and third-party control a voluntary **self-regulation initiative** might be worth considering. Yet opinions remain divided about the ultimate effectiveness of such an initiative.

Stricter requirements for the **Ecodesign Regulation on servers and data storage products** are instrumental to greening data centres and cloud computing. Yet the ultimate contribution to energy efficiency also depends on the entire operational process as well as the business model used. At the time of the study the Regulation is under review. After the adoption of the amendments which focus on a methodology to measure active and idle state power, it would be useful issuing an ecodesign preparatory study defining the minimum requirements for active and idle state performance, resource efficiency and operational conditions.

Although workshop participants indicated that access to finance is not a problem for DCs, the **Sustainable Finance Taxonomy Climate Delegated Act** remains a valuable policy measure that can facilitate investments in the refurbishment and introduction of new and greener technologies in DCs. In this context the streamlining with the eligibility criteria for Important Projects of Common European Interest, which at the time of the study are under revision, is important.

Other policy measures that initially were not directly targeted at data centres such as EMAS, the EED, the WEEE Directive, the CSR Directive, the EPBD, and the Green Claims, do have an effect on greening data centres, yet rather in an indirect manner. These measures surely help shaping a favourable regulatory environment, yet given that data centres and cloud computing services are the prime target of this study, and the indirect nature of these measures, these policy measures are not main candidates for greening data centres and cloud computing. However it remains important to guard the consistency and coherence between the direct measures, in particular the CoC and mandatory GPP, and the other measures as this would reduce compliance costs, create (lead) market leverage and as such increase the energy and resource efficiency of data centres. An important step in this direction has been taken by the adoption of the Fit for 55 package in July 2021.

Evidently policy measures need to be implemented and one of the key hindrances that need to be overcome in this respect is the myriad of concepts and **definitions of data centres** and the metrics to measure energy and resource efficiency. We analysed the various concepts that are used at the time of the study and concluded that it is recommended to use the definition in the CoC as a starting basis and further align it with the one of the EN50600 standard and then add these to the participant or best practice guidelines documents. We also recommend avoiding the use of the term ‘managed service provider’ to prevent confusion. More detail is provided in chapter 2.1. (Task 1.1.1.) where we among others present a taxonomy of DCs, and chapter 3.2. (Task 2.1.) where we analyse the definition in the context of applications for policy measures. The size criteria and thresholds as defined in the following table were perceived by the workshop participants as realistic.

Criteria and thresholds for dividing data centres according to size class (small, large, hyperscale)

	Small deployment	Large deployment	Hyperscale deployment
Floor size	100 m ² - 1000 m ²	1000 m ² - 10.000 m ²	more than 10.000 m ²
Number of racks	6 to 200	200 to 2000	2000+
Power capacity	50kW – 1 MW	1MW – 10MW	10MW+

Concerning the **methods for measuring the energy and resource efficiency of data centres** (task 1.1.3) our analyses have shown that there are already a large number of different methods and metrics that focus on data centres and their individual components. Particularly useful are the metrics from the European Data Centre Standard EN 50600-4 key performance indicators (KPIs) series, some of them still under development, which very systematically describe the different environmental characteristics of data centres and support them with measurement methods. However the existing metrics have a clear focus on energy-related issues, and circular economy aspects are still insufficiently covered by the metrics. With regard to climate protection, leakage quantities of refrigerants from cooling systems and the associated greenhouse gas emissions are still insufficiently recorded.

Despite the challenges in terms of definitions and metrics, we conclude that by pursuing the three policy measures namely (i) improvements to the Code of Conduct, (ii) compulsory green public procurement criteria for publicly procured data centres, server rooms and cloud services and (iii) the set-up of a European Data Centre Registry and by simultaneously implementing coherent specifications in other (indirect) policy measures a favourable regulatory environment can be established that fosters greening of data centres and cloud computing, both for large multinational data centres as well as for SMEs operating in the edge segment.

Policy options for a transparency mechanism on the environmental footprint of ECNs and ECSs

Based on extensive analyses in the study one may conclude that there are currently **two main areas of focus to the ecological optimisation of telecommunications infrastructures**:

- The first focus is the **deployment of energy efficient network infrastructure**, for example in the construction of new mobile radio base stations or antennas, new fixed Internet access cabinets or the deployment of broadband cables.
- The second focus is the **provision of eco-friendly telecommunications services by ECN operators**, i.e. mobile telephony or broadband contracts, fixed telephone connections, fixed internet connections, business-to-business data lines, cable TV or other services that require a fixed or mobile connection to the electronic communications network.



Deployment of new network components

For the planning of new networks, the ECN sector has developed a variety of metrics (see tasks 1.2.3 and 1.2.5) to determine the energy efficiency of the components used already in the planning phase and to build energy-optimised systems. This practice could be further promoted by giving particularly energy-efficient networks a more favourable treatment, for instance in permit granting (e.g. accelerated procedures), in the use of public infrastructure (roads, cable ducts, facilities, frequencies), or in the selection procedures for state aid projects. This could be based on indicators such as the energy intensity of the network [kWh/GByte]. In addition, the study proposes that telecom operators record the energy intensity of the network in a central or national register (**ECN Energy Register**), similar to the register proposed for the data centres, in order to create an overview of the different providers and the efficiency of the different network technologies. Regulators, professional buyers as well as investors or financial institutions can get an overview of the efficiency of the respective provider by comparing within the database. The data contained in the proposed ECN energy register should be made available in such a transparent way that it can be further processed, for example to generate information for end-users on the efficiency of providers.

Transparency towards customers in the delivery of telecommunication services

One of the objectives of this study was to investigate what transparency measures by ECN providers could help to ensure that customers of telecommunication services can choose energy-efficient offers, thus creating competition for the most environmentally friendly services (see task 1.2.4). For this purpose, various metrics were considered as well as the opinions of consumer protection organisations were surveyed. The most promising possible transparency measure identified is the **introduction of an energy efficiency –type of label for telecommunications services**. The specific energy consumption of the communication service could be shown on the label in a colour scale as well as a classification from A to G. The label could also include information on the carbon footprint of the service and the share of renewable energies used. When selling and advertising telecommunication services, the energy efficiency label would need to be shown.

The existing instrument is already very well established on the market for many electrical appliances (lamps, refrigerators, washing machines, air conditioners, etc.) and it therefore offers good conditions for it to be well accepted by consumers. However, it should be noted that in addition to methodological challenges, the existing efficiency label is assigned for physical products (goods) and could not be used for services. In addition to private customers, the information provided by the energy efficiency label could also be used by professional buyers and the public sector in the context of green public procurement (GPP). As a metric on which the efficiency scale is based, various options were discussed in the study.

It is important for a suitable metric that it should not be a pure performance metric that for example assumes maximum data traffic, but that the **energy demand must be related to an understandable and realistic usage unit** (e.g. per connection, per average subscriber or per hour of usage). In order to identify the best calculation method for the efficiency indicator, more research is therefore needed in the further design of an energy efficiency –type of label.

The need for minimum efficiency and Ecodesign requirements

Both proposed policy options (ECN energy register and energy efficiency label) are information tools that are intended to promote competition for the most efficient telecom service. So far, information on the energy efficiency of telecommunication networks and services is still very scarce. Network operators typically do not make such information publicly available. Therefore, it is also not possible to identify what energy consumption is appropriate for an electronic communications network. After the introduction of the transparency measures mentioned above, however, this data situation would change. The evaluation of the data in the proposed ECN energy register and the information on the energy efficiency label per telecom service could create the basis for identifying inefficient systems and services.

For the future, pure transparency measures could be expanded and policy instruments to set minimum efficiency requirements could be introduced. The study proposes two further instruments that could be considered in the coming years. With regard to the **deployment of electronic communication networks (ECNs)**, the **introduction of minimum efficiency requirements** in the permit granting process or as prerequisite for subsidising deployment projects could promote efficiency competition. With regard to the telecommunication services (ECSs), **Ecodesign –type of requirements for telecom services** could set efficiency standards, and thus make the market more climate-friendly. However, it should be noted that the existing Ecodesign Directive applies to “energy-related products”, defined as goods, and not to services. For these two additional policy instruments, it was not yet possible to carry out impact assessments within the framework of the present study due to the unsatisfactory data situation.

Résumé

Contexte

La transformation numérique rapide actuelle se caractérise par une augmentation de la quantité de données à enregistrer, traiter, stocker et transmettre, ce qui requiert une augmentation de la capacité d'infrastructure informatique et de la consommation d'énergie et de ressources qui en découle. Cette tendance numérique suscite donc des inquiétudes quant à son impact sur l'environnement, notamment au regard du Green Deal européen qui vise une économie plus numérique et écologiquement responsable. Afin de permettre cette double transition - numérique et verte - il sera important d'introduire des mesures politiques qui améliorent l'efficacité énergétique et les pratiques d'économie circulaire dans les chaînes de valeur des TIC. Cette étude vise à informer et à proposer de futures mesures politiques, en se concentrant spécifiquement sur le cloud computing et les datacenters, ainsi que sur les services et systèmes de télécommunication.

Objectifs de l'étude

Les objectifs de cette étude peuvent être classés en fonction de deux parties principales de la chaîne de valeur des TIC qui font l'objet de cette étude :

Datacenters et cloud computing :

1. Proposer des mesures politiques afin d'augmenter l'efficacité énergétique et l'efficacité des ressources des datacenters et évaluer l'impact environnemental, social et économique.
2. A l'appui de cet objectif, réaliser :
 - Une analyse des définitions et des types de datacenters et déterminer des seuils de taille pertinents ;
 - Une analyse des pratiques actuelles du marché liées à la circularité et identifier les moyens potentiels pour augmenter la circularité ;
 - Une analyse des normes, mesures, indicateurs, méthodes et méthodologies qui sont actuellement utilisés dans le domaine afin d'évaluer l'efficacité énergétique et l'efficacité des ressources et une évaluation de leur pertinence pour l'inclusion dans les mesures politiques ;
 - Identifier les lacunes dans les chaînes de valeur où le potentiel d'efficacité énergétique et/ou de circularité est perdu et les mesures potentielles pour combler ces lacunes ;

Services et systèmes de télécommunication :

1. Proposer des options politiques pouvant être incluses dans un mécanisme de transparence sur l'empreinte environnementale des systèmes de télécommunication et, dans cette optique :
 - Signaler les pratiques, indicateurs, normes et méthodologies liés à l'empreinte environnementale des réseaux et services de communications électroniques
 - Rendre compte des aspects de durabilité du service offert aux consommateurs, notamment pour évaluer un certain nombre

d'indicateurs possibles en vue de la communication avec l'utilisateur final et pour analyser l'impact d'un mécanisme de transparence volontaire et obligatoire sur l'empreinte environnementale des services de communications électroniques et sur les parties prenantes concernées.

2. Examiner les critères d'évaluation de la durabilité environnementale des nouveaux réseaux de communications électroniques.

Méthodologie

Conformément aux objectifs concernant respectivement les datacenters et les services et systèmes de télécommunication, une approche séquentielle de la recherche a été élaborée en se concentrant d'abord sur les indicateurs, les pratiques et les normes, puis sur l'élaboration de mesures politiques pour l'écologisation des datacenters et d'options politiques pour les mécanismes de transparence des services et systèmes de télécommunication.

Bien que chacun des sujets de recherche énumérés dans les objectifs ait sa propre approche et ses propres spécificités, un ensemble de méthodologies transversales a été appliqué. Tout d'abord, des recherches documentaires approfondies ont été effectuées en passant en revue la littérature académique et grise pertinente. En parallèle, des entretiens approfondis ont été menés avec des cadres supérieurs de datacenters, d'opérateurs de réseaux, de fournisseurs de cloud computing, d'associations industrielles et d'experts, dans le but de mieux comprendre les pratiques actuelles du marché en matière de circularité. En outre, trois enquêtes ont été lancées, adaptées aux deux groupes cibles respectifs : datacenters et fournisseurs de systèmes de télécommunication. Ces enquêtes ont permis d'obtenir des informations supplémentaires de la part de 124 personnes au total. Les résultats intermédiaires ont été présentés et discutés lors d'un atelier et d'un événement de validation en ligne. L'atelier de validation pour les datacenters s'est tenu le vendredi 4 juin 2021 avec des représentants d'entreprises privées et d'associations nationales de divers États membres. La discussion des résultats intermédiaires pour les RCE s'est tenue le vendredi 25 juin 2021 avec des représentants d'entreprises et un représentant d'une association européenne et le 28 juin avec le groupe de travail ad hoc de l'ORECE (Organe des régulateurs européens des communications électroniques) sur la durabilité.

Mesures politiques visant à accroître l'efficacité énergétique et l'efficacité des ressources des datacenters écologiques et de cloud computing

Sur base d'analyses approfondies, des réactions des parties prenantes lors des enquêtes, des entretiens et, surtout, de l'atelier en ligne, il est possible de proposer un certain nombre de mesures politiques réalisables, efficaces et spécifiquement ciblées sur les datacenters et le cloud computing. Selon nous, il s'agit d'une combinaison de :

- améliorations du code de conduite (ci-après dénommé "CdC") ;
- des critères obligatoires de marchés publics écologiques pour les datacenters, les salles de serveurs et les services cloud faisant l'objet de marchés publics ; et
- la création d'un registre européen des datacenters.

D'autres mesures sont également intéressantes et utiles, mais elles semblent davantage axées sur des aspects particuliers des datacenters et de cloud computing ou affectent plutôt indirectement leur efficacité énergétique et leur efficacité en matière de ressources.

1. Code de Conduit



2. Marchés Publics Écologiques



3. Registre des Datacenters



Le **code de conduite (CdC)** est un instrument important pour rendre les datacenters plus écologiques. Dans cette étude, un certain nombre d'améliorations potentielles ont été évaluées. La consultation des parties prenantes indique qu'il est important de maintenir l'approche des meilleures pratiques et que son caractère volontaire doit être conservé. La fixation d'objectifs quantitatifs d'efficacité énergétique a été perçue comme un défi en raison des grandes différences régionales au sein de l'UE en termes de climat, d'accès aux sources d'énergie renouvelables et de modèles économiques. Des conditions de concurrence équitables au niveau européen sont essentielles. Néanmoins, nous pensons qu'il devrait être possible d'introduire un objectif quantitatif d'efficacité énergétique largement accepté, tel que le Power Usage Effectiveness (PUE), combiné à des gammes reflétant les différences de conditions régionales et à une classification des datacenters. Le contrôle par des tiers est perçu comme ayant une valeur ajoutée, à condition que l'indépendance des certificateurs et la confidentialité des informations puissent être garanties. Compte tenu des avantages perçus d'une version améliorée du CdC, les méthodes visant à accroître la participation sont précieuses. Les initiatives qui s'adressent aux datacenters des PME sont particulièrement bienvenues, à la fois pour diffuser l'expertise nécessaire à la mise en œuvre des meilleures pratiques et pour améliorer le financement et le développement des modèles commerciaux.

Le **passage de critères fondamentaux MPE volontaires à des critères obligatoires** pour les datacenters et les services cloud faisant l'objet de marchés publics aurait non seulement une fonction de signal importante de la part des autorités qui mettent en œuvre des mesures dans leurs propres domaines d'activité, mais favoriserait également l'écologisation des datacenters et des services de cloud computing. Force est de constater que le segment du marché privé est beaucoup plus important. Toutefois, compte tenu de la numérisation croissante des services publics, le secteur public peut créer une masse critique et prendre la tête du marché dans le segment des datacenters et des services de cloud computing. Comme dans le cas du CdC, il est important de créer des conditions de concurrence équitables au niveau de l'UE et d'assurer aux petits datacenters un accès égal au marché public des datacenters.

La troisième mesure politique la plus réalisable est **la création d'un registre européen des datacenters** où la consommation d'énergie et l'utilisation de matériaux sont déclarées de manière transparente. Ce registre peut être développé en parallèle et en cohérence avec

l'amélioration du CdC et les critères obligatoires des marchés publics écologiques (MPE) indiqués ci-dessus. Les points critiques à résoudre sont le traitement des informations commerciales confidentielles, la définition précise des indicateurs à fournir, ainsi que le contrôle et la gestion du registre. Il ne s'agit pas de défis insurmontables qui peuvent être résolus de manière adéquate en utilisant, par exemple, un protocole mutuellement convenu entre les opérateurs de datacenters et l'organisation responsable du registre. Le registre permettrait de suivre et d'analyser les progrès réalisés en matière d'écologisation des datacenters et de fournir des informations commerciales précieuses aux parties prenantes. En combinaison avec le registre européen des datacenters et le contrôle par des tiers, une initiative d'autorégulation volontaire pourrait être envisagée. Cependant, les avis restent partagés quant à l'efficacité finale d'une telle initiative.

Les exigences plus strictes du règlement sur l'écoconception des serveurs et des produits de stockage de données contribuent à rendre les datacenters et l'informatique dématérialisée plus écologiques. Cependant, la contribution finale à l'efficacité énergétique dépend également de l'ensemble du processus opérationnel ainsi que du modèle économique utilisé. Au moment de l'étude, le règlement est en cours de révision. Après l'adoption des amendements qui se concentrent sur une méthodologie pour mesurer la puissance en état d'activité et en état d'inactivité, il serait utile de publier une étude préparatoire d'écoconception définissant les exigences minimales pour la performance en état d'activité et en état d'inactivité, l'efficacité des ressources et les conditions opérationnelles.

Bien que les participants à l'atelier aient indiqué que l'accès au financement n'est pas un problème pour les datacenters, la **Taxonomie de la finance durable - Acte délégué sur le climat** reste une mesure politique précieuse qui peut faciliter les investissements dans la rénovation et l'introduction de technologies nouvelles et plus vertes dans les datacenters. Dans ce contexte, la rationalisation avec les critères d'éligibilité pour les projets importants d'intérêt européen commun, qui sont en cours de révision au moment de l'étude, est importante.

D'autres mesures politiques qui initialement ne visaient pas directement les datacenters, telles que l'EMAS, l'EED, la directive WEEE, la directive CSR, la directive EPBD et les allégations vertes, ont un effet sur l'écologisation des datacenters, mais plutôt de manière indirecte. Ces mesures contribuent certainement à façonner un environnement réglementaire favorable, mais étant donné que les datacenters et les services de cloud computing sont la cible principale de cette étude, et la nature indirecte de ces mesures, ces mesures politiques ne sont pas les principaux candidats à l'écologisation des datacenters et de cloud computing. Cependant, il reste important de veiller à l'homogénéité et à la cohérence entre les mesures directes, en particulier le CdC et les MPE obligatoires et les autres mesures, car cela permettrait de réduire les coûts de mise en conformité, de créer un effet de levier sur le marché (principal) et, en tant que tel, d'accroître l'efficacité énergétique et l'efficacité des ressources des datacenters. Un pas important dans cette direction a été franchi par l'adoption du paquet "Fit for 55" en juillet 2021.

De toute évidence, les mesures politiques doivent être mises en œuvre et l'un des principaux obstacles à surmonter à cet égard est la myriade de concepts et de **définitions des datacenters** et les paramètres de mesure de l'efficacité énergétique et des ressources. Nous avons analysé les différents concepts utilisés au moment de l'étude et avons conclu qu'il est

recommandé d'utiliser la définition du CdC en tant que base de départ et de l'aligner sur celle de la norme EN50600, puis de les ajouter aux documents des participants ou aux guides de bonnes pratiques. Nous recommandons également d'éviter l'utilisation du terme "fournisseur de services gérés" pour éviter toute confusion. Plus de détails sont fournis dans le chapitre 2.1. (Tâche 1.1.1.) où nous présentons, entre autres, une taxonomie des DC, et au chapitre 3.2. (Tâche 2.1.) où nous analysons la définition dans le contexte des applications des mesures politiques. Les critères et les seuils de taille définis dans le tableau suivant ont été perçus par les participants à l'atelier comme réalistes.

Critères et seuils de répartition des datacenters en fonction de la classe de taille (petite, grande, à grande échelle)

Taille	Petit datacenter	Grand datacenter	Datacenter à grande échelle
Superficie	100 m ² - 1000 m ²	1.000 m ² - 10.000 m ²	Plus que 10.000 m ²
Nombre de racks	6 - 200 Racks	200 - 2.000 Racks	Plus que 2.000 Racks
Capacité de puissance	50 kW _{el} - 1 MW _{el}	1 MW _{el} - 10 MW _{el}	Plus que 10 MW _{el}

En ce qui concerne **les méthodes de mesure de l'efficacité énergétique et des ressources des datacenters** (tâche 1.1.3), nos analyses ont montré qu'il existe déjà un grand nombre de méthodes et de mesures différentes qui se concentrent sur les datacenters et leurs composants individuels. Les mesures de la série d'indicateurs clés de performance (ICP) de la norme européenne pour les datacenters EN 50600-4, dont certaines sont encore en cours de développement, sont particulièrement utiles car elles décrivent très systématiquement les différentes caractéristiques environnementales des datacenters et les accompagnent de méthodes de mesure spécifiques. Cependant, les mesures existantes sont clairement axées sur les questions liées à l'énergie, et les aspects d'économie circulaire sont encore insuffisamment couverts par les mesures. En ce qui concerne la protection du climat, les quantités de fuites de réfrigérants des systèmes de refroidissement et les émissions de gaz à effet de serre associées sont encore insuffisamment enregistrées.

Malgré les défis en termes de définitions et d'indicateurs, nous concluons qu'en appliquant les trois mesures politiques, à savoir (i) les améliorations du CdC, (ii) les critères obligatoires de marchés publics écologiques pour les datacenters, les salles de serveurs et les services de cloud computing, et (iii) la création d'un registre européen des datacenters, et en mettant simultanément en œuvre des spécifications cohérentes dans d'autres mesures politiques (indirectes), il est possible d'établir un environnement réglementaire favorable qui encourage l'écologisation des datacenters et de cloud computing, tant pour les grands datacenters multinationaux que pour les PME opérant dans le segment périphérique..

Options politiques pour un mécanisme de transparence sur l'empreinte environnementale des réseaux et services de télécommunication

Sur base des analyses approfondies de l'étude, nous pouvons conclure qu'il existe actuellement deux grands domaines d'intérêt pour l'optimisation écologique des infrastructures de télécommunications :

- Le premier axe est le déploiement d'une infrastructure de réseau économe en énergie, par exemple dans la construction de nouvelles stations de base ou antennes de téléphonie mobile, de nouvelles armoires d'accès à Internet fixe ou le déploiement de câbles à haut débit.
- Le deuxième axe est la fourniture de services de télécommunication écologiques par les opérateurs de télécommunication, c'est-à-dire les contrats de téléphonie mobile ou à large bande, les connexions téléphoniques fixes, les connexions Internet fixes, les lignes de données interentreprises, la télévision par câble ou d'autres services qui nécessitent une connexion fixe ou mobile au systèmes de télécommunication.

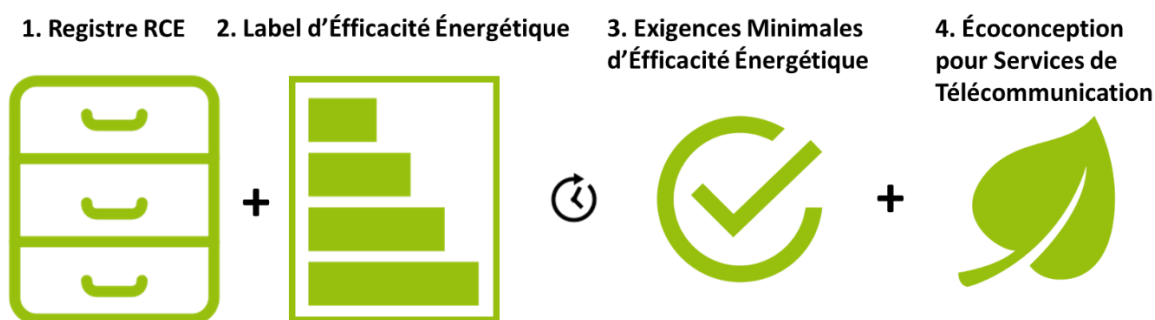

Déploiement de nouveaux composants de réseau

Pour la planification de nouveaux réseaux, le secteur ECN a développé une variété de mesures (voir tâches 1.2.3 et 1.2.5) pour déterminer l'efficacité énergétique des composants utilisés dès la phase de planification et pour construire des systèmes optimisés sur le plan énergétique. Cette pratique pourrait être encouragée en accordant aux réseaux particulièrement efficaces sur le plan énergétique un traitement plus favorable, par exemple lors de l'octroi de permis (par exemple, procédures accélérées), lors de l'utilisation d'infrastructures publiques (routes, canalisations de câbles, installations, fréquences) ou lors des procédures de sélection pour les projets d'aide publique. En outre, l'étude propose que les opérateurs de télécommunications enregistrent l'intensité énergétique du réseau dans un registre central ou national (registre énergétique ECN), similaire au registre proposé pour les centres de données, afin de créer une vue d'ensemble des différents fournisseurs et de l'efficacité des différentes technologies de réseau. Les régulateurs, les acheteurs professionnels ainsi que les investisseurs ou les institutions financières pourraient ainsi obtenir un aperçu de l'efficacité du fournisseur respectif en effectuant des comparaisons dans cette base de données. Les données contenues dans le registre énergétique ECN proposé doivent être mises à disposition de manière transparente afin qu'elles puissent être traitées ultérieurement, par exemple pour générer des informations pour les utilisateurs finaux sur l'efficacité des fournisseurs.

Transparence envers les clients-consommateurs dans la prestation des services de télécommunication

L'un des objectifs de cette étude était d'examiner quelles mesures de transparence prises par les fournisseurs de systèmes de télécommunication pourraient contribuer à garantir que les clients des services de télécommunication puissent choisir des offres économes en énergie, créant ainsi une concurrence pour les services les plus respectueux de l'environnement (tâche 1.2.4). À cette fin, divers paramètres ont été pris en compte et les opinions des organisations de protection des consommateurs ont été sondées. La mesure de transparence possible la plus prometteuse identifiée est l'introduction d'un type de label d'efficacité énergétique pour les services de télécommunication. La consommation d'énergie spécifique du service de communication pourrait être indiquée sur l'étiquette sous la forme d'une échelle de couleurs et d'une classification de A à G. L'étiquette pourrait également contenir des informations sur l'empreinte carbone du service et la part d'énergies renouvelables utilisées. Lors de la vente et de la publicité des services de télécommunication, l'étiquette d'efficacité énergétique devrait être affichée.

Cet instrument est déjà très bien établi sur le marché pour de nombreux appareils électriques (lampes, réfrigérateurs, machines à laver, climatisations, etc.) et offre donc de bonnes conditions pour qu'il soit bien reçu par les consommateurs. Il convient toutefois de noter qu'en plus des défis méthodologiques, des défis juridiques doivent encore être surmontés, car l'étiquette d'efficacité existante est actuellement attribuée à des produits physiques (marchandises) et ne pourrait pas être utilisée pour les services électroniques. Il serait nécessaire de modifier l'orientation du règlement sur l'étiquetage énergétique en passant des "produits liés à l'énergie" aux "produits et services liés à l'énergie". Outre les clients privés, les informations fournies par le label d'efficacité énergétique pourraient également être utilisées par les acheteurs professionnels et le secteur public dans le cadre des marchés publics écologiques (MPE). Différentes options ont été examinées dans le cadre de l'étude en ce qui concerne le paramètre sur lequel repose l'échelle d'efficacité.

Il est important pour une mesure appropriée qu'elle ne soit pas une mesure de performance pure qui suppose par exemple un trafic de données maximal, mais que la demande d'énergie soit liée à une unité d'utilisation compréhensible et réaliste (par exemple par connexion, par abonné moyen ou par heure d'utilisation). Afin d'identifier la meilleure méthode de calcul pour l'indicateur d'efficacité, des recherches supplémentaires sont donc nécessaires pour la conception ultérieure d'un type de label d'efficacité énergétique.

La nécessité de respecter des exigences minimales en matière d'efficacité et d'écoconception

Les deux options politiques proposées (registre énergétique de systèmes de télécommunication et label d'efficacité énergétique) sont des outils d'information destinés à promouvoir la concurrence pour le service de télécommunication le plus efficace. Jusqu'à présent, les informations sur l'efficacité énergétique des réseaux et services de télécommunication sont encore très rares. Les opérateurs de réseaux ne mettent généralement pas ces informations à la disposition du public. Par conséquent, il n'est pas non plus possible de déterminer quelle est la consommation d'énergie appropriée pour un réseau de communications électroniques. Toutefois, après l'introduction des mesures de transparence mentionnées ci-dessus, cette situation des données pourrait changer.

L'évaluation des données dans le registre énergétique proposé pour les systèmes de télécommunication et les informations sur le label d'efficacité énergétique par service de télécommunication pourraient créer la base pour identifier les systèmes et services inefficaces.

Pour l'avenir, les mesures de transparence pure pourraient être étendues et des instruments politiques visant à fixer des exigences minimales d'efficacité devraient être introduits. L'étude propose deux autres instruments qui pourraient être envisagés dans les années à venir. En ce qui concerne le déploiement des systèmes de télécommunication, l'introduction d'exigences minimales d'efficacité dans le processus d'octroi des permis ou comme condition préalable au subventionnement des projets de déploiement pourrait promouvoir la concurrence en matière d'efficacité. En ce qui concerne les services de télécommunication (ECS), des exigences de type écoconception pour les services de télécommunication pourraient fixer des normes d'efficacité et rendre ainsi le marché plus respectueux du climat. Toutefois, il convient de noter que la directive actuelle sur l'écoconception s'applique aux "produits liés à l'énergie", définis comme des biens, et non aux services. Pour ces deux instruments politiques supplémentaires, il n'a pas encore été possible de réaliser des évaluations d'impact dans le cadre de la présente étude en raison de la situation insatisfaisante des données.

1. Introduction, background and objectives

1.1 The digital transformation and increased policy attention towards energy efficiency and circular economy

Digital transformation describes a technological structural change characterised by increasing computerisation and digital networking. This trend affects nearly all areas of the economy and society, from technical infrastructures, industrial production facilities and administrations to households as well as their equipment with consumer goods. The rapid digital transformation of the economy and society entails a constantly increasing use of information and communication technologies (ICT), as ever greater volumes of data have to be recorded, processed, stored and transmitted. ICT hardware represents the material basis for the digital transformation. In particular, the digital background infrastructures such as data transmission networks and data centres are constantly increasing in scale and capacity. The International Energy Agency estimates (IEA 2020)¹, that the global internet traffic has grown 12-fold, or around 30% per year since 2010. The global internet traffic is expected to double to 4.2 trillion gigabytes by 2022. The more data we create, the more ecologically important data centres and networks become (Liu et al. 2019). As a consequence of the global growth trend in data volume transferred, a further increase in the global resource requirements for the establishment of network equipment and the energy consumption for their operation is expected, followed by an increase in e-waste volumes.

A comprehensive assessment of the global environmental impacts related to the total energy- and resources demand of the whole digital infrastructure has not been undertaken thus far (Köhler et al. 2018). However, regarding energy demand, it is estimated that the ICT sector accounts for approximately 7% of the global electricity consumption, and it is forecasted that the share will rise to 13% by 2030 (Bertoldi et al. 2017). It is important to note that this study will focus solely on data centres, and on the electronic communications services and networks. The area of end-user devices is out of this study's scope.

Total energy demand and carbon footprint

The electricity demand of data centres specifically is close to 0.8% of the global final electricity demand, and amounts to approximately 200 TWh globally in 2019 (IEA 2020) (Figure 1). By 2030, their energy consumption is estimated to grow 5-fold up to 974 TWh worldwide (3.9%), with a best-case scenario of 366 TWh (1.5%) (Andrae 2020a).²

¹ IEA (2020). Data Centres and Data Transmission Networks, IEA, Paris. <https://www.iea.org/reports/data-centres-and-data-transmission-networks#resources>

² Andrae, A.S.G. (2020a) New perspectives on internet electricity use in 2030. Engineering and Applied Science Letters DOI: 10.30538/psrp-easl2020.0038

Figure 1: Global data centre energy demand by data centre type, 2010-2022

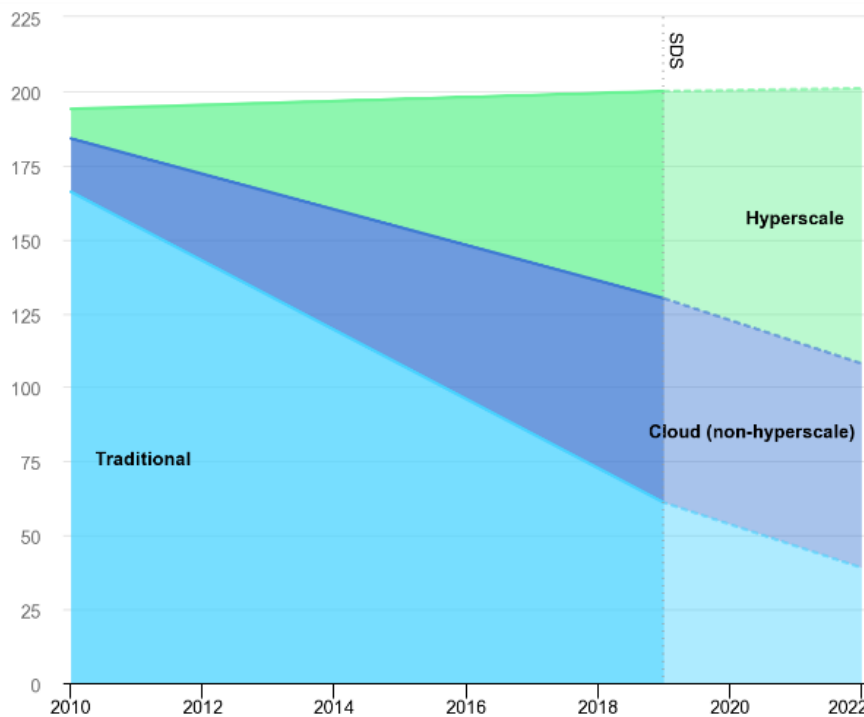

Source: (IEA 2020)

For data transmission networks, the energy demand accounted for around 1% of global electricity use in 2019 (IEA 2020), amounting to 250 TWh. A similar value has also been reported by ITU-T L.1470 (01/2020) with 276 TWh in 2020. The absolute electricity consumption of networks is projected to rise to about 300 TWh in 2030 (ITU-T L.1470 01/2020), even though the transmission networks are rapidly becoming more efficient (IEA 2020).

If we look at the global carbon footprint related to energy consumption of data centres and communication networks, Belkhir and Elmeligi, (2018) estimate this will range between 1.1 and 1.3 Gt CO₂-eq in 2020.³ Andrae (2020b)⁴ estimates the total carbon footprint related to energy consumption of data centres and data networks in 2020 around 0.30 Gt, which amounts to almost 1% of the estimated total CO₂ emissions in 2020 (i.e. 30.6 Gt) (IEA, 2020). Andrae (2020b) further differentiates this estimated carbon footprint according to energy consumption of data centres, mobile data networks and optical data networks (figure 3). For data centres, it is estimated that in 2020, the generation of electricity consumed worldwide emitted approximately 0.16 Gt CO₂, which is projected to increase by 163% in 2030. For mobile networks use, the same author estimates CO₂ emissions around 0.054 Gt in 2020 and 0.14

³ Belkhir, L., & Elmeligi, A. (2018). Assessing ICT global emissions footprint: Trends to 2040 & recommendations. *Journal of Cleaner Production*, 177, 448–463. doi:10.1016/j.jclepro.2017.12.239

⁴ Andrae A.S.G. (2020b) Hypotheses for primary energy use, electricity use and CO₂ emissions of global computing and its shares of the total between 2020 and 2030. *WSEAS TRANSACTIONS on POWER SYSTEMS* DOI: 10.37394/232016.2020.15.6

Gt CO₂ in 2030, a rise of 150%. Emissions for optical data networks are estimated at 0.083 Gt CO₂ in 2020 and are expected to rise by 81% in 2030 (ibid).

Figure 2: Global estimated carbon footprint related to energy consumption (in Gt CO₂), 2020-2030

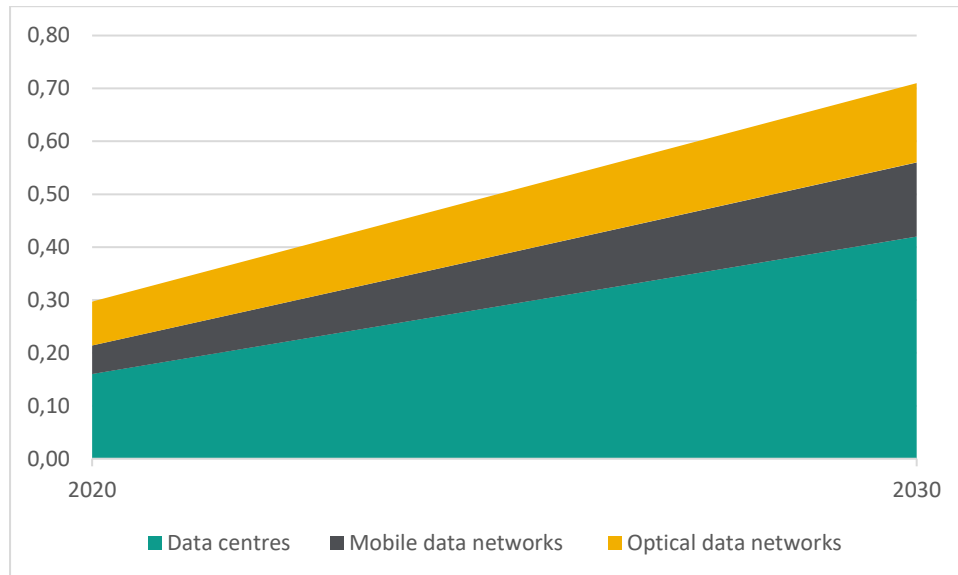

Source: based on data from Andrae A.S.G. (2020), table 6

Energy efficiency

It is noteworthy that the total power consumption of data centres worldwide has not grown much since 2010 despite a 7.5-fold increased computation workload and a 12-fold increase in network traffic. Clearly, the energy efficiency of data centres has steadily increased during the past decade. This is mainly the result of a transition from small scale data centres to highly energy efficient “hyperscale” data centres. Such large-scale data centres are big investments that can aim for optimal processor efficiency and reductions in idle-state power consumption (due to better workload planning) (Masanet, et al., 2020). As can be seen in Figure 3, global capital expenditure has more than doubled from 13 billion euros in 2016 to over 29 billion euros in Q4 2019. This trend is not expected to slow down in the foreseeable future with Amazon, Google, Microsoft, Facebook and Apple spending the most on hyperscale capital expenditure.⁵

⁵ Synergy Research Group – Statista estimates, (2019), Global hyperscale operators capital expenditure (CAPEX) from 1st quarter of 2016 to 4th quarter of 2019, consulted online: <https://www.statista.com/statistics/1109393/global-hyperscale-operators-quarterly-capex/>

Figure 3: Global hyperscale operators' capital expenditure (CAPEX) (in billion euros)

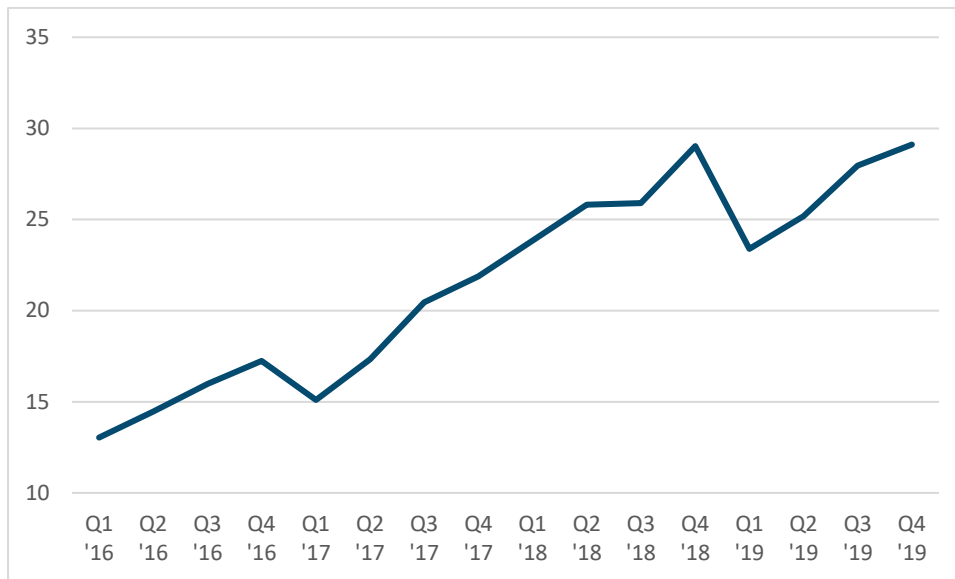

Source: Synergy Research Group; Statista estimates, 2019

Resource efficiency

Next to energy, raw materials are essential for securing a transition to green electronic communication and cloud computing services. So far, the scientific knowledge on the consumption of raw materials, especially for the network equipment and infrastructure along with the technology generations are not conclusive due to the prevailing data gaps (Liu et al. 2019). It is known, however, that digital technologies are composed of a complex inventory of materials, for example semiconductors, special technology metals (such as cobalt, lithium), trace metals (e.g. gold, palladium, silver) or doping elements (such as boron, phosphorus) and this for intermediate parts as well as for final end-user equipment. Some of them (like lanthanum, cerium) are considered critical due to their geologic scarcity or dependence on imports.

Nonetheless, the total stock of ICT hardware in operation is constantly growing. From 2016 to 2017, the amount of electrical and electronic equipment (EEE) put on the market in the EU increased by 6.5% from 8.4 million tonnes to 8.9 million tonnes in Europe alone⁶. This entails increasing amounts of raw materials consumed for the production of digital hardware such as microprocessors, memory chips, solid state memory, and opto-electronic components but also auxiliary hardware such as cooling systems and power supply.

Up to now, the use of resources for digital hardware has mostly not been oriented towards a circular economy. This becomes evident by the fast growing amount of waste generated by electric and electronic equipment (WEEE). Figure 4 illustrates the surge in amounts of e-waste generated globally. Only a small fraction of e-waste is properly recycled. In the EU, the current recycling target is 45% for collection of waste electrical and electronic equipment. Towards the

⁶ Eurostat (2020) https://ec.europa.eu/eurostat/statistics-explained/index.php?title=Waste_statistics_-_electrical_and_electronic_equipment&oldid=480557

transition to a circular economy, there is still a sizeable unexploited potential for recovery of resources from WEEE.

Figure 4: Electronic waste generated worldwide from 2010 to 2019

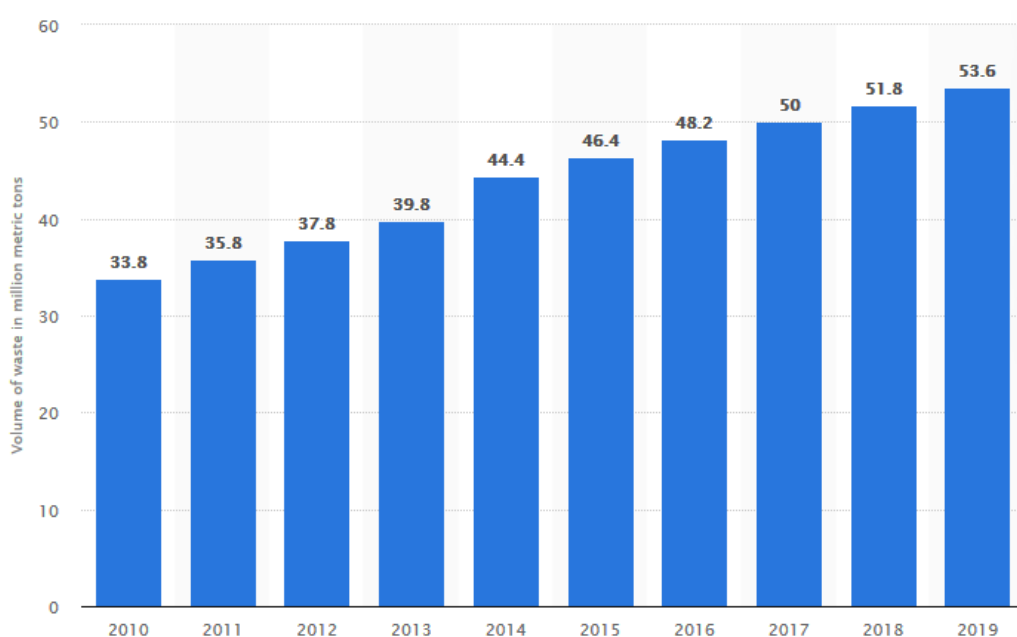

Source: The Global E-Waste Monitor (2020) p.24⁷

Existing EU policy initiatives

The general ambition to facilitate and stimulate the digital transition while also working toward climate-neutrality is embodied in the new Industrial Strategy⁸ launched by the Commission in March 2020 and updated in May 2021⁹. The Industrial Strategy is based on three main focus areas: the green transition, the digital transition and global competitiveness. Designed to support all minor and major players, the strategy could be seen as a cornerstone for all European industries as the Commission aims to remove barriers to the single market for European companies while also working toward climate-neutrality. The European Green Deal represents a paradigm shift in European politics that is designed to lead the change towards making the European economy digitalised and environmentally sustainable. The long-term goal of the new growth strategy is to make Europe the first carbon neutral continent by 2050. The intermediate goal is to decrease greenhouse gas emissions by 55% by 2030. This entails

⁷ The Global E-Waste Monitor (2020) Quantities, flows, and the circular economy potential, [GEM 2020_def_dec_2020-1.pdf](https://www.ewastemonitor.info/GEM_2020_def_dec_2020-1.pdf) ([ewastemonitor.info](https://www.ewastemonitor.info))

⁸ European Commission (2020) A New Industrial Strategy for Europe, available at <https://eur-lex.europa.eu/legal-content/EN/TXT/?qid=1593086905382&uri=CELEX:52020DC0102>

⁹ European Commission (2021), Updating the 2020 industrial strategy: towards a stronger single market for Europe's recovery, available at https://ec.europa.eu/growth/content/updating-2020-industrial-strategy-towards-stronger-single-market-europes-recovery_en

greater efforts in Research & Development & Innovation (R&D&I) that will eventually shape EU policy and have a direct impact on industry and civil society.

Clean and energy-efficient digital technologies are considered essential to enabling access to the digital information society and to securing growth and sustainable consumption. Within the Green Deal it is recognised that, although digital technologies may enable green solutions, measures to further improve energy efficiency and circular economy performance of these technologies themselves need to be put in place. This package puts forward energy efficiency as a key objective. In the Commission's priority 'A Europe fit for the digital age' actions were previewed to make sure the digital strategy of the EU is in line with achieving climate neutrality by 2050.

An important step in the mitigation of environmental impacts of digital technologies, is acquiring insight in the energy and circular economy performance of (the production and use of) ICT hardware. To this end, transparent and coherent indicators to properly inform, compare, monitor, evaluate, and ultimately improve life cycle energy use and footprint, are of paramount importance. Some policy actions take this insight explicitly into account. A first example is the Communication 'Shaping Europe's Digital Future' of February 2020¹⁰ that refers to transparency measures for telecom operators on their environmental footprint. Another example is the Circular Economy Action Plan¹¹ that envisions the development of environmental accounting principles, a better environmental data disclosure and mandatory green public procurement rules in sectoral legislation combined with compulsory reporting. Within this Action Plan the Circular Electronics Initiative is one of the key actions for product value chains. Moreover, at the time of the study, the Commission is elaborating a proposal for a regulation on Product and Organisation Environmental Footprint methods (PEF/OEF)¹² that requires companies to substantiate their claims about the environmental footprint of their products and services, making use of standard quantification methods. Additionally, the Commission is working on a proposal for a directive with the aim to strengthen the role of consumers in the green transition.¹³ The proposal targets three fronts i) relevant and reliable information, ii) preventing greenwashing and iii) the setting of minimum requirements for sustainability logos and labels.

¹⁰ Communication Shaping Europe's digital future, COM(2020) 67.

¹¹ European Commission (2020) A new Circular Economy Action Plan – For a cleaner and more competitive Europe, Brussels, 11.3.2020 COM(2020) 98 final, available from [EUR-Lex - 52020DC0098 - EN - EUR-Lex \(europa.eu\)](https://eur-lex.europa.eu/eli/reg/2020/1013/oj)

¹² Environmental performance of products and businesses – substantiating claims; for more detail see [Environmental performance of products & businesses – substantiating claims \(europa.eu\)](https://eur-lex.europa.eu/eli/reg/2020/1013/oj)

¹³ Consumer policy – strengthening the role of consumers in the green transition; for more detail see [Consumer policy – strengthening the role of consumers in the green transition \(europa.eu\)](https://eur-lex.europa.eu/eli/reg/2020/1013/oj)

1.2. Measuring circular economy performance of data centres and cloud computing, electronic communications services and networks

Digitalisation and the circular economy are closely interlinked. Circularity of data centre and cloud computing services refers to the efficient use of the resources that are allocated in data centres and digital networks in form of ICT-hardware, consisting of semiconductors and other materials as well as metals and plastics, which form the material base of computing services.

The Circular Economy Action Plan of the European Commission¹⁴ aims to “reduce its consumption footprint and double its circular material use rate in the coming decade.” In the context of ICT, circularity is understood as instrumental to preserve resources and make the EU economy more independent from imports of critical raw materials. This should be achieved by increasing product lifetimes (by means of fostering repair, re-use) as well as updating obsolete software. Moreover, improving the collection and treatment of Waste Electrical & Electronic Equipment (WEEE) is an important instrument to improve the circularity of the ICT sector, which is regulated in the WEEE directive¹⁵ and in a wider sense by the Waste Framework Directive¹⁶.

Additionally, circularity is related to the potential that digital services bear towards the dematerialisation of the economy. Digital services can create value on an immaterial level. Digitally enabled applications could make significant contributions towards a circular economy, e.g. with the help of interconnected digital tools, which may help improve the use of natural resources, design, production, consumption, reuse, repair, remanufacturing, recycling, and waste management.

Nevertheless, digital services require a material basis of ICT hardware, in fact – the ongoing digital transformation causes a substantial increase in demand for new and more powerful ICT hardware, notably backbone infrastructure such as data networks and data centres. Data centres and data transmission networks including their infrastructures cause a variety of undesired impacts on the ecological sustainability, notably the increasing consumption of energy and raw materials. From this background, the policy target of increasing the circularity of the EU economy necessitates the ICT hardware to become circularity compatible. To this end, several strategies need to be implemented in the design and planning as well as operation of digital infrastructures.

There are many approaches to increase the circularity of ICT. Some examples are extended producer responsibility, improving the framework conditions for the repair and reuse of hardware, increasing the collection rate of ICT goods, monitoring critical raw materials, or

¹⁴ Communication from the Commission to the European Parliament, the Council, the European Economic and Social Committee and the Committee of the Regions: A new Circular Economy Action Plan For a cleaner and more competitive Europe, COM(2020) 98.

¹⁵ Directive 2012/19/EU of the European Parliament and of the Council of 4 July 2012 on waste electrical and electronic equipment (WEEE) (recast) , retrieved from <https://eur-lex.europa.eu/legal-content/EN/TXT/?uri=CELEX:02012L0019-20180704>

¹⁶ Directive 2008/98/EC of the European Parliament and of the Council of 19 November 2008 on waste and repealing certain Directives , retrieved from [EUR-Lex - 32008L0098 - EN - EUR-Lex \(europa.eu\)](https://eur-lex.europa.eu/legal-content/EN/TXT/?uri=CELEX:32008L0098-EN)

collaborative economy sharing services (Liu et al. 2019)¹⁷. The measures to reduce resource consumption differ depending on the application. Professional ICT, such as data centre components and network devices, can be addressed with different measures than those for consumer devices. However, a precondition for the success of the implementation of circularity instruments is the possibility to monitor, measure, and evaluate their impacts. Currently, there is a lack of adequate measures and indicators as well as methods that help determining the progress towards resource efficiency in ICT. In contrast to energy efficiency, resource efficiency has barely been considered thus far. Hence there is a variety of energy performance indicators for data centres and digital networks but no adequate indicators for circularity related aspects, such as resource efficiency, hardware life-time and reparability/updatibility.

In 2019, the most prevalent methods for data centre operators to measure success of their operations were the overall performance and utilisation (56% of survey respondents)¹⁸, followed by total cost of ownership (TCO - 41%) and return on investment (ROI - 38%). These three metrics are also considered to be the more traditional success metrics while the other metrics presented in Figure 5 are considered to be more closely associated with the greening of data centres. Only 14% of surveyed data centre operators and IT practitioners indicated total cost to the environment (TCE) to be a method of measuring success.

Figure 5: Methods operators of data centre infrastructure use to measure success worldwide 2019, in Percent

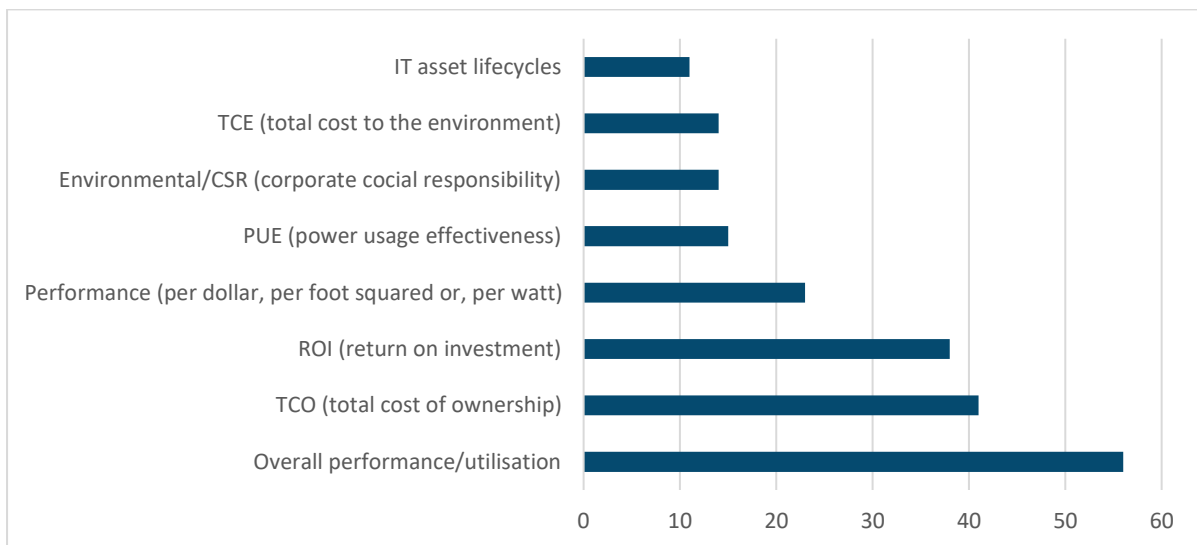

Source: Supermicro, 2019, Report on the State of the Green Data Center. N = 1362

¹⁷ Liu et al. 2019: issue paper “Digital transformation: Impacts of the digital transformation on the environment and sustainability” on behalf of DG Environment, European Commission, accessible at https://ec.europa.eu/environment/enveco/resource_efficiency/pdf/studies/issue_paper_digital_transformation_20191220_final.pdf

¹⁸ Supermicro, (2019), Data Centers & the Environment, 2019 Report on the State of the Green Data Center, p. 4.

Concerning the current circular economy performance of data centres and communication networks, we can conclude that:

- No comprehensive analysis of circular economy performance of data centres and data transmission network exists.
- Systemic impacts of ICTs and their application on the environment (or ‘third-order’ effects) should be investigated for cloud computing services and digital applications, including the intended and unintended consequences such as the medium- or long-term adaptation of behaviour (e.g. consumption patterns) or economic structures. The most-discussed effect is the rebound-effect, which means that efficiency gains are cancelled out or overcompensated for by increased use (e.g. more intensive lighting through energy-efficient LED luminaires). However, quantifying systemic impacts is currently not possible due to i) complexity, and various factors involved, ii) methodological issues and iii) data gaps.
- There is a need to establish a comprehensive database of information regarding the material inventory of data centres and data transmission networks and their infrastructures, at least in the EU.
- There is a need to map and describe best practices regarding maintenance, re-use, refurbishment, re-manufacturing as well as secondary markets for data centre components and materials.
- There is a need to establish the degree of ‘circularity’ of data centre operations at the material resource level and map the end-of-life pathways of the data centre hardware.
- Finally, appropriate indicators, metrics and policy measures should be developed in order to close the loop for material resources related to data centres and digital networks

1.3. Objectives of the Study

Given the large energy and material resource requirements of data creation, transmission, storage and use described in sections 0 and 0, and the increasing demand of industries that are going digital as well as private consumers requiring digital services, it is important to introduce measures to enhance energy efficiency and require improved circular practices from data centres, as well as electronic communication services and networks. The COVID-19 pandemic has further highlighted the need for policy measures to promote circularity and resource and energy efficiency¹⁹. Specifically in the digital sector, the pandemic has opened a window for change in business models (3DP, IoT, AI, robotics, DLT, ...), work organisation and even social and cultural events, further exacerbating the need for an energy efficient and circular digital sector.

Together with the increased attention of policy and society to the momentum of digital solutions, their environmental footprint is gaining attention. Helping to achieve optimal energy

¹⁹ WEF (2020), Opportunities for a circular economy post COVID-19, online: <https://www.weforum.org/agenda/2020/06/opportunities-circular-economy-post-covid-19/>

efficiency rates and circular economy performance while avoiding adverse economic and social impacts on society is the ultimate goal of the study, contributing to achieving climate neutrality by 2050 as stated in the Green Deal.

In order to provide a clear view and a common base of understanding, the study starts by providing a set of definitions of data centres and cloud computing services that can be supported by the various stakeholders involved in the field, allowing to appreciate the differences between them with respect to size, services provided, and other criteria identified as important. Once a clear use of terms and definitions has been allowed for, an extensive analysis of data centres, cloud computing institutions, electronic communications services and networks provides an overview of current industry practices both for data centres and cloud computing, and for electronic communications services and networks.

More specifically, the goals for the respective parts of the digital value chain under the scope of the study are:

Data centres and cloud computing:

1. To propose policy measures for increasing the energy and resource efficiency of data centres and assess the environmental, social and economic impact.
2. In support of that objective to perform:
 - An analysis of data centre definitions and types and determine meaningful size thresholds;
 - An analysis of current market practices related to circularity and identify potential ways to increase circularity;
 - An analysis of standards, metrics, indicators, methods and methodologies that are currently used in the field for assessing energy and resource efficiency and an assessment of their suitability for inclusion in policy measures
 - To identify gaps in the value chains where potential for energy efficiency and/or circularity is lost and potential measures to bridge these gaps;

Electronic communications services and networks:

1. To propose policy options that could be included in a transparency mechanism on the environmental footprint of ECNs and in view of this:
 - To report practices, indicators, standards and methodologies related to the environmental footprint of electronic communications networks and services
 - To report on sustainability aspects of the service offered to consumers (in particular to assess a number of possible indicators in view of end-user communication and for analysing the impact of a voluntary and mandatory transparency mechanism on the environmental footprint of electronic communications services and on relevant stakeholders.
2. To consider criteria for the assessment of the environmental sustainability of new electronic communications networks.

From an ICT value chain perspective, the study focusses on data centres and cloud computing and on the electronic communications services and networks. The area of end-user devices is out of this study's scope.

Table 1 provides an overview of the various objectives of this study ordered along two dimensions: horizontally the particular segments of the ICT value chain that this study focusses on: Data Centres and Cloud Computing on the one hand and Electronic Communications Services and Networks on the other hand. The vertical dimension highlights the process steps and tasks in the study ordered in two major blocks: part 1 indicators and standards and part 2 policy measures and options.

The results from our analyses on indicators and standards in part 1 are used as input for part 2, where we have provided an in-depth qualitative and, where possible, quantitative assessment of policy options that contribute towards greening cloud computing and electronic communications services and networks.

Table 1: Objectives in the subsequent tasks ordered by ICT value chain segment and part in the study process

Data Centres and Cloud Computing

Electronic Communications Services and Networks

Part 1 – Indicators and standards

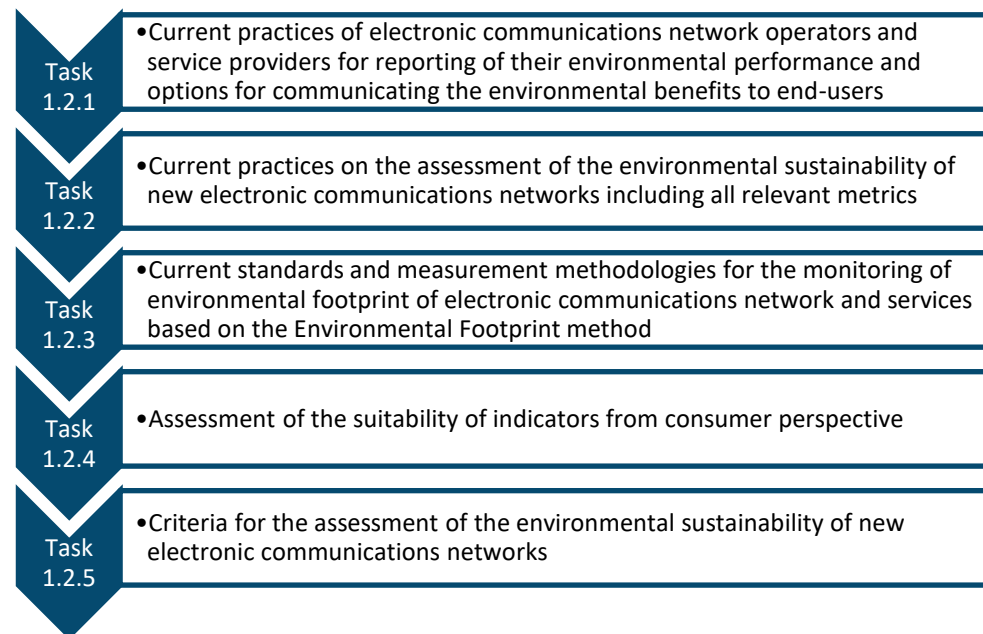
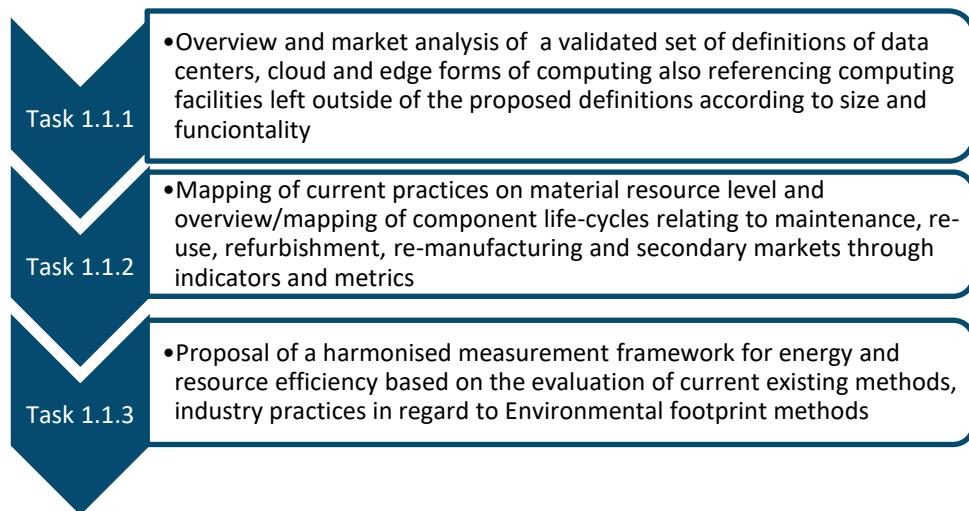

Part 2 – Policy measures and options

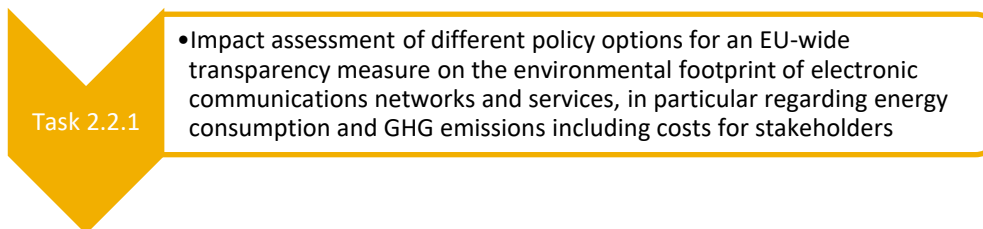
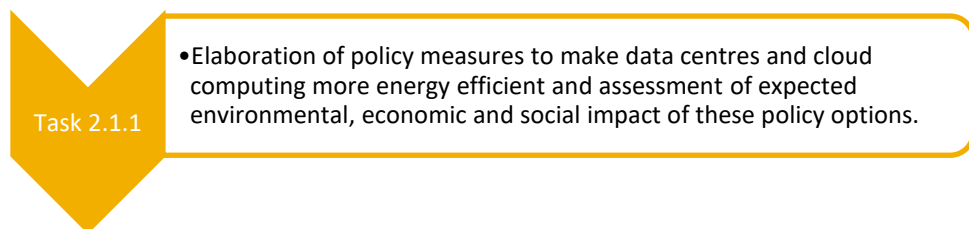

2. Final Results Part 1 – Indicators and Standards

2.1. Task 1.1: Indicators and standards: Data Centres and Cloud Computing

Task 1.1.1: Propose possible definitions of data centres

Aim of this task

Measuring energy efficiency, circular economy performance and environmental impact of data centres presumes clarity on the meaning of a data centre. Given the plethora of definitions currently used in practice, the key objective of this task is to provide the European Commission with a set of clear definitions of data centres that allow for meaningful distinctions on the basis of size and other commonly identified criteria and an assessment of the impact of these definitions on the EU data centre market constellation (market analysis). It is also asked to recommend, based on the analysis undertaken in Task 1.1.1., a specific definition option that takes into account the particularities of EU cloud service providers.

What is a Data Centre? General definitions.

A broad definition of a data centre that is used by several standardisation organisations (ISO/IEC, ETSI, CEN-CENELEC) is the one provided in the EN50600 Series of standards developed by the European Committee for Electrotechnical Standardization (CENELEC):

Definition 1 (EN50600)

“A structure, or group of structures, dedicated to the centralised accommodation, interconnection and operation of information technology and network telecommunications equipment providing data storage, processing and transport services together with all the facilities and infrastructures for power distribution and environmental control together with the necessary levels of resilience and security required to provide the desired service availability”.

As an addition to this definition two notes are provided²⁰:

- Note 1: A structure can consist of multiple buildings and/or spaces with specific functions to support the primary function.
- Note 2: The boundaries of the structure or space considered the data centre, which includes the information and communication technology equipment and supporting environmental controls, can be defined within a larger structure or building.

This broad definition encompasses several dimensions that need to be simultaneously present to determine what a data centre is:

- Infrastructure (structure/group of structures) for the accommodation, interconnection, and operation of:
 - o Information technology and,
 - o Network telecommunications equipment.

²⁰ Not every standardisation organisation adds (all of) the notes to definition 1.

- Services: data storage, processing and transport services.
- Facilities and infrastructure:
 - o For power distribution and,
 - o Environmental control.
- Resilience and security to provide the desired service availability.

Although this definition provides a broad understanding of what a data centre is and what it is not, this definition could for example also include a device for data storage and processing in a car as a data centre as no minimum size requirements are put forward or a distinction between a static or mobile structure is being made. On the other hand, on its own, it doesn't suffice to make meaningful distinctions between data centres. ETSI defines a site containing a data centre defined as above as an ICT site (ETSI EN 305 174)²¹.

Another general definition of data centres is the one put forward by the EU Horizon2020 EURECA Project²²:

Definition 2 (EURECA Project)

“Is an environment hosting digital services, with power reliability equipment (UPS, Generators, power switches, PDUs, etc.) and controlled ambient conditions (cooling and humidity).”

Although quite similar to the EN50600 definition (definition 1), this definition focuses on the necessity of the provision of power reliability equipment while managing cooling and humidity within a certain environment. If there is no cooling or no UPS one cannot speak of a data centre. Compared to the EN50600 definition it does not provide an interpretation of what digital services exactly are, does not imply infrastructure is necessary to control ambient conditions (as long as there is intentional ambient control, e.g. underwater), and does not mention IT infrastructure and network and telecommunications equipment. Avoiding the term 'infrastructure' in the context of controlling ambient conditions, leaves room for including smaller structures without active cooling equipment. Even Though the EN50600 definition does not state that you can only speak of a data centre when there is IT infrastructure and network equipment present, it does slightly suggest this by mentioning IT infrastructure and network equipment explicitly. Avoiding this could make it easier to designate for example a building with just cooling and power equipment as a data centre. Similar to the EN50600 definition, the specific environment that constitutes a data centre is not specified, it could be a building, a space within a building, a group of buildings, a car, etc. In short, this second definition put forward by EURECA seems to imply a broader coverage in terms of what can be considered a data centre.

Examples of specific definitions used by ICT (infrastructure) companies

General definitions of data centres used in industry are similar to definitions 1 and 2 but vary depending on the key activities of the company considered. Common to all is that they don't mention aspects of resilience and security in contrast to the EN50600 general definition. AFL

²¹ https://www.etsi.org/deliver/etsi_ts/105100_105199/10517402/01.03.01_60/ts_10517402v010301p.pdf

²² Rabih Bashroush, EU H2020 EURECA Project, 2018.

Hyperscale, a cabling and connectivity solutions provider for data centres, defines a data centre as “*essentially a building that provides space, power and cooling for network infrastructure. They centralize a business’s IT operations or equipment, as well as store, share and manage data*”(definition 3²³, AFL Hyperscale) highlighting the importance of network infrastructure.

Cisco, producer of IT and network components, describes a data centre as “*a physical facility that organisations use to house their critical applications and data. A data centre’s design is based on a network of computing and storage resources that enable the delivery of shared applications and data. The key components of a data centre design include routers, switches, firewalls, storage systems, servers, and application-delivery controllers*” (definition 4²⁴, Cisco), elaborating specifically on the various key components of IT infrastructure and network equipment.

Digital Reality, a real estate investment trust that invests in carrier-neutral data centres and provides colocation and peering services, puts more emphasis on the building itself by defining a data centre as “*a physical location – most commonly a building – that houses core IT and computing services and infrastructure.*” (definition 5²⁵, Digital Reality).

During several interviews with primarily data centre associations, it became clear that a broad definition of data centres is desired which allows the inclusion of a great variety of possible structures/environments in terms of size, ownership and other criteria to ensure a level playing field.

How to distinguish Data Centres? The most important typologies.

Purpose/business model/ownership

One of the most commonly used distinctions between data centres that is widely used in the literature²⁶ is the purpose of the data centre which is often linked (albeit sometimes implicitly) in the definitions to ownership of the data centre and what’s in it (e.g. support infrastructure or IT-equipment).

- **Enterprise data centre:** a data centre that is operated by an enterprise which has the sole purpose of the delivery and management of services to its employees and customers;
- **Colocation data centre (CoLo):** a data centre in which multiple customers locate their own network(s), servers and storage equipment. The support infrastructure of the

²³ <https://www.afihyperscale.com/understanding-different-types-of-data-center>

²⁴ <https://www.cisco.com/c/en/us/solutions/data-center-virtualization/what-is-a-data-center.html>

²⁵ <https://www.digitalreality.com/what-is-data-center>

²⁶ Standards: EN50600, ISO/IEC TS 22237; Other: e.g. Dodd, N., Alfieri, F., Maya-Drysdale, L., Viegand, J., Flucker, S., Tozer, R., Whitehead, B., Wu, A., Brocklehurst F., Development of the EU Green Public Procurement (GPP) Criteria for Data Centres Server Rooms and Cloud Services, Final Technical Report., EUR 30251 EN, Publications Office of the European Union, Luxembourg, 2020, ISBN 978-92-76-19447-7, doi:10.2760/964841, JRC118558,

building (such as power distribution and environmental control) is provided as a service by the data centre operator.

In an enterprise data centre, the data centre facility and IT-infrastructure is operated by one company and the only user is the company itself (its employees and customers). In a colocation data centre, the data centre operator provides support infrastructure, but customers have their own IT-equipment and services/applications. These definitions are systematically used in the current standards that are under development such as EN 50600 and ISO/IEC TS 22237. The most important distinguishing criterion between an enterprise and a colocation data centre is the ownership of the IT-equipment (networks, servers and storage equipment): the data centre operator (colocation) or the customer(s) (enterprise).

According to Salom et al (2017²⁷) the enterprise data centre type, that can be on-premise or off-premise²⁸, can be subdivided into business supporting data centres and business critical data centres.

- **Business supporting data centre**, where the primary function is to support the activities of the firm. In general, these Data Centres will provide safe, secure and reliable hosting facilities for the firms core IT systems. Since the Data Centres are not leading, but supporting, they are most frequently situated close to the actual firm or organisation, and therefore at short distance of the actual activities.
- **Business critical data centre**, which are an integral part of the main business process. These are, for example, the commercial telecom data centres and data centres of financial institutions. The data centre is at the core of their business process. Therefore, these Data Centres are situated at locations that are beneficial for the IT processes, based on criteria such as (not limited) distance to the customers, distance to a (large) power plant, cost and availability of land, (transatlantic) glass fibre connectivity or carrier neutrality options.

Also within the class of colocation data centres a further distinction in multiple subtypes is used in practice. The most popular distinction is the retail versus the wholesaled data centre. Equinix²⁹ describes both as follows:

- **Retail colocation**: In retail colocation, companies rent rack, cage or cabinet space for deploying their own IT equipment. In this model, companies have limited control over the space, but the cabling, racks, power, cooling, fire suppression systems, physical security and other amenities are immediately available.
- **Wholesale colocation**: A wholesale model allows companies to determine how the space is designed and built, but it also requires a commitment to lease much bigger chunks of space and power, commonly based on one or more discrete power

²⁷ J. Salom, T. Urbaneck and E. Oró (2017). Advanced Concepts for Renewable Energy Supply of Data Centres.

²⁸ "On-premise" refers to private data centres that companies house in their own facilities and maintain themselves. Source: https://www.hpe.com/emea_europe/en/what-is/on-premises-vs-cloud.html. The difference between on-premise and off-premise data centres was indicated by a respondent in our survey.

²⁹ Michael Winterson (2020). Hyperscale vs. Colocation. Choosing the right digital infrastructure model for your business. Equinix <https://blog.equinix.com/blog/2020/08/27/hyperscale-vs-colocation/>

distribution units, such as a 2 MW generator. Usually they also need to bring all their own resources to design and construct the space: racks, cabinets, power, etc., as well as the staff to run and maintain the space.

Varying on the specific source, additional popular data centre definitions primarily based on purpose/ownership/business model are used: (co-)hosting data centres, managed service provider (MSP) data centres, network operator data centres, etc. What is often lacking in the definitions provided, even in the same source, is how they compare to each other especially with respect to mutual exclusiveness.

EN50600 defines in addition to enterprise and colocation data centres, hosting, co-hosting and network provider data centres. These types of data centres are defined as follows:

- **Cohosting data centre:** data centre in which multiple customers are provided with access to network(s), servers and storage equipment on which they operate their own services/applications. Both the information technology equipment and the support infrastructure of the building are provided as a service by the data centre operator.
- **Hosting data centre:** a data centre within which ownership of the facility and the information technology equipment is common but the software systems are dictated by others. In short a hosting data centre hosts the software of its customers while owning/operating the support infrastructure and IT equipment.
- **Network operator data centre:** a data centre that has the primary purpose of the delivery and management of broadband services to the operators' customers.

Based on the first two definitions, a co-hosting data centre is a hosting data centre that hosts multiple customers. Crucial in both definitions is that customers of these types of data centres don't own support infrastructure nor IT-infrastructure, but do determine the services and software applications of their choice.

A network operator data centre can, based on the above definition, not be seen as distinct from the enterprise data centre defined earlier: a data centre owned by a network operator could be seen as an enterprise data centre. A data centre owned by another company than the network operator that has one or more network providers as customers could also be designated as a network operator data centre (cf. the earlier definition of a business critical data centre) . Also AFL Hyperscale³⁰ designates a network operator data centre as a telecom data centre and states it is a facility owned and operated by a telecommunications or service provider company.

In a summary report of a 2014 workshop organised by DG CONNECT³¹, several often used types of data centres are linked to who could gather and monitor the necessary information

³⁰ <https://www.aflhyperscale.com/understanding-different-types-of-data-center>

³¹ Environmentally sound Data Centres: Policy measures, metrics, and methodologies. DG CONNECT workshop. 1 April 2014. <https://ec.europa.eu/digital-single-market/en/news/report-workshop-green-data-centres-policy-measures-metrics-and-methodologies>

and data that are required to quantify energy efficiency and environmental performance (Box 1).

Box 1: Linking data centre types to information on energy efficiency and environmental performance

Enterprise data centre: Owner, operator and (main) user of data centre is the same organisation, bearing all energy cost and having access to all relevant energy efficiency and environmentally relevant data.

Co-hosting data centre: Both the information technology equipment and the support infrastructure of the building are provided as a service by the data centre operator, who bears initially all energy costs, while users pay indirectly, depending on their contracts/tariffs, which are not related to energy consumption and often are flat rates. Energy efficiency and environmentally relevant data is available at the same organisation.

Co-location data centre: The support infrastructure of the data centre (such as power distribution, security and environmental control) is provided as a service by the data centre infrastructure operator, who bears all initial energy costs. Customers pay energy costs to data centre infrastructure operator, based on their contract which include actual energy consumption and a possible fee related to the additional energy costs such as cooling systems, UPS and other losses. Energy efficiency and environmentally relevant data is hence spread across different actors.

Network operator data centre: The data centre operator bears initially all energy costs and the final users pay indirectly, depending on their contracts/tariffs, while these are not related to energy consumption and often are flat rates; similar to “Co-hosting data centre”. Energy efficiency and environmentally relevant data is spread across different actors.

Source: Summary report of 2014 workshop organised by DG CONNECT³²

A recent JRC report on the development of the EU Green Public Procurement Criteria for data centres, server rooms and cloud services³³ adds a third category, next to enterprise and colocation data centres, to make a mutually exclusive distinction between three types of data centres³⁴, namely **Managed Service Providers (MSP)**. This is a data centre offering server and data storage services where the customer pays for a service and the vendor provides and manages the required ICT hardware/software and data centre equipment. The report states

³² Environmentally sound Data Centres: Policy measures, metrics, and methodologies. DG CONNECT workshop. 1 April 2014. <https://ec.europa.eu/digital-single-market/en/news/report-workshop-green-data-centres-policy-measures-metrics-and-methodologies>

³³ Dodd, N., Alfieri, F., Maya-Drysdale, L., Viegand, J., Flucker, S., Tozer, R., Whitehead, B., Wu, A., Brocklehurst F., Development of the EU Green Public Procurement (GPP) Criteria for Data Centres Server Rooms and Cloud Services, Final Technical Report., EUR 30251 EN, Publications Office of the European Union, Luxembourg, 2020, ISBN 978-92-76-19447-7, doi:10.2760/964841, JRC118558.

that “*this management service includes the co-hosting of multiple customers, which may take the form of a cloud application environment.*”

The proposed definition, however, can be somewhat confusing and unclear for several reasons:

- Its relation to the definition of a hosting data centre.
 - o The definition implies that hosting data centres can be considered Managed Service Providers data centres, but at the same time (seems to) suggest(s) that the software systems don't need to be dictated by others, which is not consistent with the earlier definition of a hosting data centre. In other words, the definition implies that software can be offered as a managed service in a MSP
- Its relation to the definition of an enterprise data centre.
 - o It is, furthermore, not straightforward to distinguish a Managed Service Providers data centre from an enterprise data centre based on the above definitions. If a company owns a data centre and all IT hardware in it and its customers pay a fee for certain services, then it can be considered an enterprise data centre³⁵ as well as a managed service provider data centre according to the definitions above. Further refinement is necessary to distinguish between an enterprise data centre and a MSP data centre.
- Ambiguity surrounding the term “managed services”.

The term Managed Services Provider can be confusing as every data centre operator manages some kind of services (e.g. maintaining the facility, cooling and power, etc.). Although the above definitions are linked to the ownership criterion, the lack of consistently defining who owns what part of a data centre and who determines the software applications within these definitions creates confusion by allowing too much room for interpretation. There might be a difference between the owners of a building, and those that own the support infrastructure, the IT infrastructure and the applications that run on top of it.

Cloud data centre

In the context of data centre typology, there is a lot of ambiguity in what exactly constitutes a cloud data centre. Often it is presented as a different data centre type next to e.g. enterprise, colocation, hosting due to the association with particular well-known public cloud providers (often also called hyperscalers) such as Amazon, Google or Microsoft. Cisco³⁶ for example describes a cloud data centre as an off-premises form of data centre where data and applications are hosted by a cloud services provider such as Amazon Web Services (AWS), Microsoft (Azure), or IBM Cloud or other public cloud providers. In other cases a cloud data centre is designated a particular data centre type. AFL Hyperscale for example designates a

³⁵ AFL Hyperscale for example defines a hyperscale enterprise data centre as a facility owned and operated by the company it supports specifying this companies to be well-known large companies such as Amazon Web Services, Microsoft, Google or Apple.

³⁶ <https://www.cisco.com/c/en/us/solutions/data-center-virtualization/what-is-a-data-center.html#~types-of-data-centers>

cloud data centre to be a very large enterprise data centre. The JRC seems to include cloud data centres only in the Managed Service Provider data centre category (cf. supra).

If we go back to the meaning of cloud services, the most frequently cited types are software-as-a-service (SaaS), platform-as-a-service (PaaS) and infrastructure-as-a-service (IaaS).

- **Software-as-a-service:** software hosted by a vendor or provider is made available on demand over a network;
- **Platform-as-a-service (PaaS):** a platform/environment hosted by a vendor or provider is made available on demand to allow developers to build applications and services
- **Infrastructure-as-a-service (IaaS):** provides access to computing resources like virtual server space, network connections, bandwidth, and IP addresses.

A cloud service provider is then the organisation that provides one or a combination of these services. In our interviews it became clear that these cloud service providers cannot be linked to one type of data centre specifically. A cloud service provider can build its own data centre, rent IT-equipment within a colocation data centre, rent IT-equipment and the building containing it, etc. Google for example has its own data centres, but is also a client of colocation data centres. The company just picks the best option depending on the relative costs and benefits. It was stated during our interviews that in 75% to 80% of the cases cloud service providers use colocation data centres.

In general, when the cloud data centre type is used as a term, one limits its interpretation to a very large data centre that is used or owned by the largest public cloud providers. As such it is more linked to size (hyperscale) and number of tenants (mostly single tenant) than to the nature of the services offered.

Edge data centre

The simplest description of an edge data centre would be a relatively or very small data centre (below 2MW) that is physically close to its end-user (at the edge of the network) rather than further away (at the core of the network)³⁷.

An edge data centre is typically connected to a bigger central data network and/or to a Content Delivery Network (CDN) made up of Points of Presence (POP). A CDN connects different edge servers and if one edge server is inaccessible, computing orders are routed to the next available edge server. A POP is a single geographical location where edge servers (and consequently data centres) are connected to each other. When all POPs are connected, they constitute the larger CDN for the considered area.³⁸ Sometimes edge data centres are wrongly described as one side of the edge-cloud spectrum. The reason is that in this case 'cloud' is again interpreted solely as a large central data centre.

³⁷ See e.g; <https://www.sunbirdcim.com/edge-data-center>, <https://searchdatacenter.techtarget.com/definition/edge-data-center>, <https://www.vxchnge.com/blog/what-is-an-edge-data-center>, <https://www.techfunnel.com/information-technology/content-delivery-network/>

³⁸ CISCO, (2020), Cisco Visual Networking Index: Global Mobile Data Traffic Forecast Update, 2017–2022.

Edge data centres are sought for low latency high device density applications such as autonomous vehicles and other smart-city applications. Main drivers for the adoption of edge data centres are the proliferation of 5G, industrial IoT and the adoption of Software-defined networking and network functions virtualisation (SDN/NFV) technologies.³⁹

Data Centre Tiers

To classify and compare data centres one often refers to a tier system consisting of various tiers or levels based on some underlying criteria. The most prominent underlying criteria used is the continuity of data services⁴⁰. The Uptime Institute provides a tier system based on the desired availability of data services (basic capacity, redundant capacity⁴¹, concurrently maintainable, or fault tolerance)⁴². For each availability, an overview of necessary infrastructure is given. Moreover, Uptime offers a certification programme. A basic description of the four tiers is⁴³:

- **Tier I.** A Tier 1 data centre holds the **basic capacity level** required for an office setting. Although protected against disruptions from human error, unexpected failures or outages may happen. There is redundant equipment that includes chillers, pumps, UPS modules and engine generators. To perform preventive maintenance activities and repairs, a complete shutdown of the data centre is required. The absence of preventive maintenance and repairs might lead to unplanned disruptions and severe consequences from system failure. It is estimated an availability of ~99.671% and 28.8 hours of downtime per year.
- **Tier II.** Tier II facilities include **redundant capacity** components for power and cooling as to allow maintenance and safety against disruptions⁴⁴. The distribution path of Tier II serves a critical environment, and components can be removed without shutting down the facility. Like a Tier I data centre, unexpected shutdown of a Tier II data centre will affect the system. It is estimated an availability of ~99.741% and 22 hours of downtime per year.
- **Tier III. Concurrently maintainable** with redundant components as a key differentiator, with redundant distribution paths to serve the critical environment. No

³⁹ PWC, (2019), Edge data centers: Riding the 5G and IoT wave, p. 6.

⁴⁰ Mark Acton (2008), European Data Centre Standards. CBRE. <https://www.slideshare.net/ICTFOOTPRINTEU/european-data-centre-standards>.

⁴¹ Redundancy denotes the duplication of certain components or functions of a system so that if they fail or need to be taken down for maintenance, others can take over. N is the base load or number of components needed to function. N+1 means having one more component than is actually needed to function, 2N means having double the amount of total components, and 2N+1 is having double the amount plus one (J. Salom, T. Urbaneck and E. Oró (2017). Advanced Concepts for Renewable Energy Supply of Data Centres).

⁴² <https://uptimeinstitute.com/tiers>

⁴³ <https://uptimeinstitute.com/tiers>

⁴⁴ Components include: engine generators, energy storage, chillers, cooling units, UPS modules, pumps, heat rejection equipment, fuel tanks and fuel cells (<https://uptimeinstitute.com/tiers>).

shutdowns are required when the equipment needs maintenance or replacement. The components of Tier III are added to Tier II components so that any part can be shut down without impacting IT operation. A tier III data centre is still susceptible to fault and thus only addresses unplanned events. It is estimated an availability of ~99.982% and 1.6 hours of downtime per year.

- **Tier IV.** A Tier IV data centre has multiple independent physically isolated systems that act as redundant capacity components and distribution paths. The separation is needed to protect against an event that otherwise might compromise both systems. The environment will not be affected by a disruption from planned as well as unplanned events. Tier IV facilities add **fault tolerance** to the Tier III topology. When equipment fails, or an interruption in the distribution path occurs, IT operations will not be affected. All of the IT equipment must have a fault-tolerant power design to be compatible. Tier IV data centres additionally require continuous cooling to ensure a stable environment. It is estimated an availability of ~99.995% with 0.4 hours of downtime per year.

In 2009 Uptime removed specific availability predictions to tier levels⁴⁵ based on, so they state, *“the understanding that operational behaviours can have a huge impact on site availability regardless of the technical prowess of the design and build”*. The various requirements of each tier are summarized in Table .

⁴⁵ These were: 99.671% and 28.8 hours of downtime per year (Tier 1), 99.741% and 22 hours of downtime per year (Tier 2), 99.982% and 1.6 hours of downtime per year (Tier 3) and 99.995% with 0.4 hours of downtime per year (Tier 4).

Table 2: Uptime tier requirements summary

	Tier I	Tier II	Tier III	Tier IV
Minimum Capacity Components to Support the IT Load	N	N+1	N+1	N After any Failure
Distribution Paths – Electrical Power Backbone	1	1	1 Active and 1 Alternative	2 Simultaneously Active
Critical Power Distribution	1	1	2 Simultaneously Active	2 Simultaneously Active
Cocurrently Maintainable	No	No	Yes	Yes
Fault tolerance	No	No	No	Yes
Compartmentalization	No	No	No	Yes
Continuous Cooling	No	No	No	Yes

Source: The Uptime Institute (2018). Data Centre Typology.

Two other standards that make use of tiers to categorise data centres based on the Uptime typology are EN50600 (for facilities and infrastructures and ANSI/TIA-942 (for telecommunications infrastructure)⁴⁶. EN50600 covers all aspects of the data centre infrastructure and elaborates availability requirements for power, cooling and telecommunications infrastructure. The Uptime Institute Tier Topology primary focuses on power and cooling and TIA942 targets telecommunications cabling. The general principle used in these typologies is essentially the same, and is described in Table 3.

Table 3: General principle of availability typologies

Tier/Rating/Class	Description
1	Enough items for the system to function
2	Some redundancy in components

⁴⁶ Capitoline, Data Centre Certification – Who can certify? Which Data Centre Standard? <https://www.capitolinetraining.com/data-centre-certification-who-can-certify-which-data-centre-standard/> .

Tier/Rating/Class	Description
3	Concurrent maintainability i.e. the ability to maintain any item of infrastructure without having to shut down the IT equipment.
4	Automatic fault tolerance. The system continues operating in the event of a failure without human intervention.

Source: Capitoline (2021), Data Centre Certification – Who can certify? Which Data Centre Standard?

During our interviews, it was stated that a lot of end-users of higher tier data centres actually don't need the corresponding high availability rates. In light of this study, this is an important remark, as higher availability in general goes together with more energy consumption, and by consequence: a higher environmental footprint.

Other tiers/ratings/classes used in EN50600 relate to protection and energy granularity⁴⁷:

- Four protection classes against unauthorized access, internal fire, internal environmental events, and external environmental events. A criterion to distinguish between data centres could be the maximum protection class against the four different categories of events.
- Three levels of energy efficiency measurement granularity:
 - o Level 1: simple information for the entire data centre.
 - o Level 2: detailed information for certain installations and infrastructures of the DC.
 - o Level 3: Granular data for individual DC elements.

Size

There are no standard thresholds to determine what a small, large or hyperscale data centre is. There is also no consensus on what the most relevant size criterion is: floor size, power capacity, number of server racks, etc. Indications of criteria and thresholds used in practice were however acquired through desk research and interviews. Via the survey for data centre operators, additional insights in the thresholds used in practice were acquired.

The KTH Royal Institute of Technology of Sweden defines data centres using a minimum threshold for power capacity of 0.1MW (down from 0.5MW in 2017)⁴⁸. This falls within the boundaries of what is denoted as a very small data centre by Salom, Urbaneck & Oró (2017)⁴⁹:

⁴⁷ J. Dittrich (2015). EN50600-Series. Data Centre Facilities & Infrastructures. <https://docplayer.net/6452375-En-50600-series-data-centre-facilities-infrastructures-jens-dittrich-ceo-dvt-consulting-ag-convener-cenelec-tc-215-wg3.html>

⁴⁸ <https://www.diva-portal.org/smash/get/diva2:1130513/FULLTEXT01.pdf>

⁴⁹ J. Salom, T. Urbaneck and E. Oró (2017). Advanced Concepts for Renewable Energy Supply of Data Centres

- Server room: <50 kW
- Very small Data Centre: 50–250 kW
- Small Data Centre: 250–1000 kW
- Medium size Data Centre: 1–2 MW
- Large Data Centre: 2–10 MW
- Very large Data Centre: >10 MW

The authors clarify that all data centre types can range from very small to large. As a general rule supporting enterprise data centres are the smallest while hosting data centres are the largest.

AFL Hyperscale describes for various types of data centres size thresholds based on power capacity and additional criteria such as the number of cabinets and floor size⁵⁰:

- Hyperscale (or Enterprise Hyperscale):
 - o Cabinets: 500 or more
 - o Floor size: 10 000 square feet or more (~930 m²)
 - o Number of servers: 5000 servers or more
- Wholesale colocation data centre:
 - o Cabinets: from 100 cabinets to more than 1000
- Enterprise data centre:
 - o Cabinets: from 10 cabinets upwards
 - o Power capacity: can be as large as 40MW

Although some size thresholds are specified by AFL Hyperscale, they are not consistently reported for the various types of data centres. What is however clear is that data centres defined based on purpose/ownership criteria (such as enterprise or colocation) can vary in size.

The Data Center Energy Usage report of the US Department of Energy offers is, to our knowledge, the most granular categorisation of data centres according to size⁵¹. The minimum size for a structure to be designated a data centre is approximately 45 m² (500 ft²). A hyperscale data centre can be up to about 37000 m² (400.000 ft²). In Table 4 an overview of the various size classes is given.

Table 4: Size classes of data centres according to the US Data Center Energy Usage Report

Type of structure	Floor size	Description
Internal server closet	< 100 ft ²	Often outside of central IT control (often at a remote

⁵⁰ Data Centres for which no size thresholds were defined are not mentioned here.

⁵¹ Shehabi et al (2016). United States Data Center Energy Usage Report. Ernest Orlando Lawrence Berkeley National Laboratory. <https://www.osti.gov/servlets/purl/1372902/>

Type of structure	Floor size	Description
		location) that has little to no dedicated cooling.
Internal server room	100-1.999 ft ²	Usually under IT control, may have some dedicated power and cooling capabilities
Localised internal data centre	500-1.999 ft ²	Has some power and cooling redundancy to ensure constant temperature and humidity settings.
Midtier internal data centre	2.000-19.999	Superior cooling systems that are probably redundant.
High-end internal data centre	>20.000 ft ²	Has advanced cooling systems and redundant power.
Point-of presence server closet	<100 ft ²	At local points of presence for OSS and BSS services. Typically leverages POP power and cooling. Space is often a premium.
Point-of-presence server room	100-999 ft ²	Secondary computer point of presence for OSS and BSS services. Typically leverages POP power and cooling.
Localised service provider data centre including sub-segment: containerised data centre	500-1.999 ft ²	Has some power or cooling redundancy to ensure constant temperature and humidity settings. These are typically facilities set up by VARs to provide managed services for clients.
Midtier service provider data centre	2.000-19.999 ft ²	Location for small or midsize collocation/hosting provider. Also includes regional facilities for multinational communications service providers. Has superior cooling systems that are probably redundant.
High-end service provider data centre	>20.000 ft ²	Primary server location for a service provider. May be subdivided into modules for greater flexibility in expansion/refresh. Has

Type of structure	Floor size	Description
		advanced cooling systems and redundant power.
Hyperscale data centre	Up to over 400.000 ft ²	Primary server location for large collocation and cloud service providers. Based on modular designs, with individual modules of 50,000 ft ² on average in up to 8 modules. Employs advanced cooling systems and redundant power.

Source: Shehabi et al (2016). United States Data Center Energy Usage Report. Ernest Orlando Lawrence Berkeley National Laboratory. <https://www.osti.gov/servlets/purl/1372902/>

During the interviews, primarily with data centre associations, it became clear that in general a good size criterion needs to be one that is user-friendly for the reporting organisation in terms of measurement. The most straightforward criterion is therefore floor size, followed by the number of racks. Furthermore, all interviewees saw size as one of the most important criteria to distinguish data centres next to ownership and availability/reliability. The importance of size, it was mentioned, is related to the large amount of smaller data centres that have less capital to invest in measures aimed at greening their businesses, and therefore are often much less efficient in terms of energy use. It was also stated that small data centres are in danger of being excluded in the greening data centre discussion.

An additional remark was that, within the boundaries of a specific country, what is considered a small, large or hyperscale data centre varies. This classification depends on the size of data centres that are built within a certain country, which is determined by factors such as demand (e.g. large cities that generate high demand), geography (e.g. availability of large free plots of land to build data centres), and climate (e.g. in cooler climates it is easier to remove heat by using outside air, availability of wind/hours of sunshine to generate renewable energy). Nevertheless, during the interviews, the thresholds mentioned were often similar. Table 5 shows the size thresholds that were derived from the interview responses.

It needs to be stated that every association interviewed confirmed there are no generally accepted definitions according to size and that small deployments, even those outside the above minimum thresholds, are seen as relevant. In other words: even a single server rack can be someone's data centre. During an interview it was, however, clarified that it is hard to speak of a 'real' data centre when there are less than 6 racks due to absence of systematic operations of e.g. support infrastructure and IT equipment. Another element that was highlighted is that thresholds underlying size categorisations might and probably will change over time. More relevant than the thresholds themselves are the elements of a data centre that change when it gets larger, e.g. use of automation, redundant components, modularity, etc.

Table 5: Size thresholds used to categorise data centres – DC interview results

	Small deployment	Large deployment	Hyperscale deployment
Power capacity	Starting from around 30kW	1MW – 10MW	10MW or more, up to 50MW or even 100MW
Floor size	100 m ² - 1000 m ²	1000 m ² - 10.000 m ² (lower than 5000 m ² is sometimes considered small)	More than 10.000 m ²
Number of racks	Minimum 6	Several hundred	Could be 2000+

Source: IDEA Consult, Oeko-Institut, Visionary Analytics, 2021, Interviews with DC associations, DC operators, and other industry stakeholders

On the other hand, the results of the survey directed to data centre operators, reveal a great variety in what they consider to be the minimum thresholds of power capacity and number of racks for a structure to be designated a data centre. The same observation holds with respect to the thresholds used to indicate what a small, large or hyperscale data centre is. Table 6 summarizes the results.

Table 6: Size thresholds used to categorise data centres – DC survey results

Metric	Minimum	Maximum	Mode	Median
<i>MINIMUM THRESHOLDS</i>				
Minimum power capacity (in MW)	0,01	2	0.1	0.5
Minimum number of racks	1	400	50	50
SMALL DATA CENTRE				
Power capacity (in MW)	0.05	2	0.5	0.5
Floor size (in m ²)	50	600	500	300
Number of racks	10	1750	100	90
LARGE DATA CENTRE				
Power capacity (in MW)	0,3	50	1	4.25
Floor size (in m ²)	200	20000	1500	1500
Number of racks	50	5000	200	500
HYPERSCALE DATA CENTRE				
Power capacity (in MW)	1	125	100	22.5
Floor size (in m ²)	900	50000	50000	10000
Number of racks	200	20000	10000	4000

Source: IDEA Consult, Oeko-Institut, Visionary Analytics, 2021, Survey to data centre operators.

Note: Question: *What is, in your opinion, the minimum power capacity (in MW) and/or number of racks a structure needs to have to be considered a data centre?*, N=13-15.

Other definitions/criteria

Below some examples of other definitions and criteria (that could be used for new definitions) are listed. Other relevant examples will be distilled from our survey for data centres.

- Internal versus service provider data centre
 - o Internal DCs are available to businesses and institutions, while service provider DCs provide specialised services to communication companies and social media companies⁵².
- Software Defined Data Centre (SDDC⁵³)
 - o A programmatic abstraction of logical compute, network, storage, and other resources, represented as software. These resources are dynamically discovered, provisioned, and configured based on workload. Thus, the SDDC enables policy-driven orchestration of workloads, as well as measurement and management of resources consumed.
- Location
 - o Regional, national and international data centres⁵⁴: Regional data centres can be found in one province and have one or more facilities. National data centres have facilities spread over the country. International data centres focus on the distribution of online services to multiple countries (e.g. The Amsterdam data hub).
 - o Data centres located in metropolitan versus rural areas⁵⁵
- Type of end-users (e.g. telecom providers, internet service providers, internet exchange providers, cloud providers, enterprises, financial institutions, public organisations, etc.)
- PUE (Power Usage Effectiveness)
- Number of tenants
- Maximum rack power
- Sector distribution according to the reporting form for participants in the Code of Conduct:
 - o traditional enterprise;
 - o on demand enterprise;
 - o telecom;
 - o high performance computing cluster;
 - o hosting;
 - o Internet;
 - o hybrid⁵⁶.

⁵² <https://www.osti.gov/servlets/purl/1372902>

⁵³ Distributed Management Task Force, inc. (DMTF). Software Defined Data Center (SDDC) Definition. A White Paper from the OSDCC Incubator. https://www.dmtf.org/sites/default/files/standards/documents/DSP-IS0501_1.0.0.pdf

⁵⁴ <https://www.dutchdatacenters.nl/en/data-centers/what-is-a-data-center/>

⁵⁵ Criteria mentioned in the survey to data centre operators.

⁵⁶ <https://publications.jrc.ec.europa.eu/repository/bitstream/JRC108354/kina28874enn.pdf>

- Cooling technologies: type of free cooling technologies⁵⁷
- Criteria mentioned by DC operators in the survey:
 - o Density: a higher density denotes the use of more kW per rack or cabinet.⁵⁸
 - o Modularity: a modular data centre is based on a design that implies either a prefabricated data centre module or a deployment method for delivering data centre infrastructure in a modular, quick and flexible method⁵⁹.
 - o Usage of renewable energy
 - o Waste heat utilization
 - o Connectivity options (to other data centres and service providers within and outside Europe)
 - o Remote hands: a service offered by colocation data centres that allows customers of a data centre to outsource basic IT maintenance tasks to technicians that are employed by the data centre, allowing customers to focus on their own core business⁶⁰.

⁵⁷ <https://publications.jrc.ec.europa.eu/repository/bitstream/JRC108354/kjna28874enn.pdf>

⁵⁸ <https://virtusdatacentres.com/item/389-power-density-the-real-benchmark-of-a-data-centre>

⁵⁹ <https://www.datacenterknowledge.com/archives/2013/04/04/what-is-a-modular-data-center>

⁶⁰ <https://cloudscene.com/news/2017/07/definesaas/>

Overview of data centre types by criterion

The following figure provides an overview of the frequently used types of data centres we reported in this section and their underlying criteria. The most popular criteria are purpose/ownership, size, tiers, location and centralisation/service. In the final column we highlight additional criteria that are used to categorise data centres, but are less frequently used. This overview highlights the multitude and complexity of data centre typologies used in practice.

Figure 6: Data centre definition overview

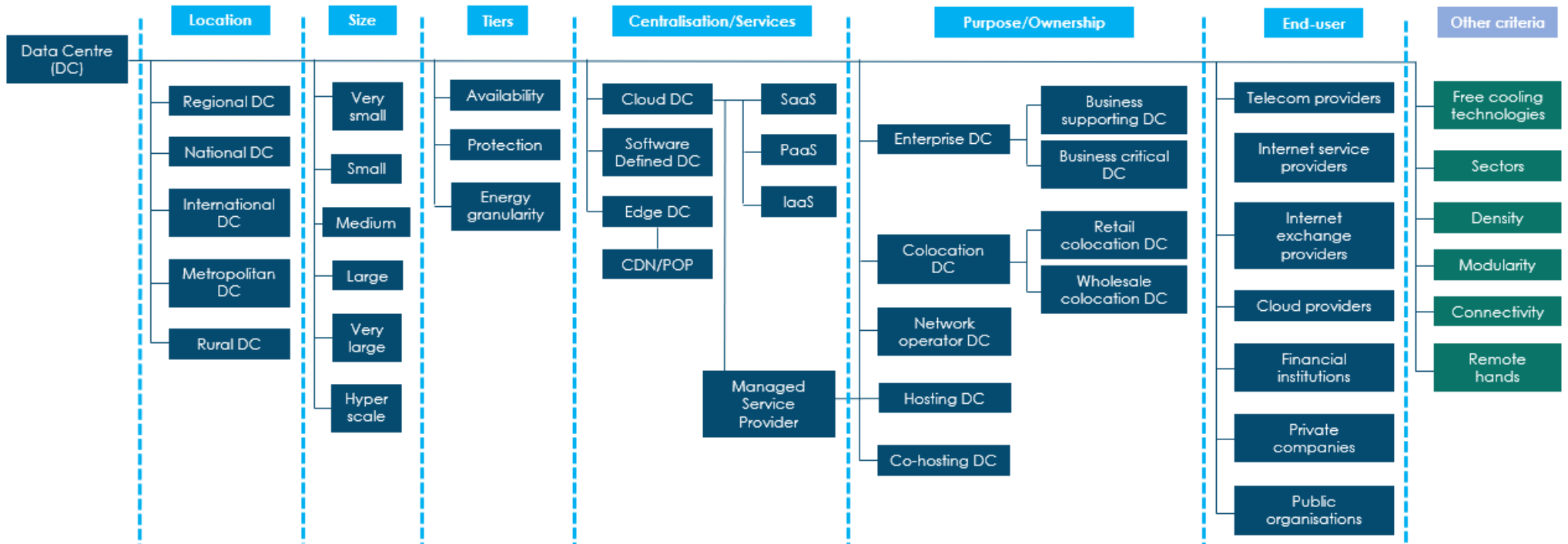

Source: IDEA Consult, 2021

Market analysis

Currently, to our knowledge, exhaustive and high quality datasets with a broad geographic coverage that should be at the basis of a thorough market analysis do not exist. This lack of good datasets was acknowledged by the various data centre associations that we approached during our interviews. At the moment of the study some of them are gathering data themselves. Due to this lack of data, we relied on the limited amount of existing studies available and on insights from our survey to data centre operators⁶¹.

Market share of data centres by purpose (enterprise, colocation and MSP) in terms of total number and size

One of the few studies that includes market data with a large coverage while also indicating how data centres are defined is the 2020 JRC Report on the development of the EU Green Public Procurement (GPP) Criteria for Data Centres, Server Rooms and Cloud services. In the two tables below, respectively the estimated data centre white space⁶² (m²) and the number of data centres are given by type and country. As a minimum threshold, a power capacity of 25kw was used. The definitions of enterprise data centre, colocation data centres and MSP data centres are in accordance with the ones we provided earlier.

⁶¹ See Appendix 6 for a distribution report of the survey to data centre operators and owners.

⁶² White space refers to the area where the actual IT equipment is placed. This equipment is for instance servers, data storage, racks, power distribution, cooling. It can be a raised floor or a hard floor. Typically IT-engineers operate the white space. Grey space supports the white space equipment and includes back-end infrastructure such as generators, chillers, transformers, energy storage. Grey space houses the mechanical and electrical parts of the data centre, and as such is the operating scene for the electrical and mechanical engineers.

Table 7: Market share of European data centres by purpose (in white space, and in number)

Market	Enterprise data centres		Co-location data centres		Managed Service Provider data centres	
	Number	White space (m ²)	Number	White space (m ²)	Number	White space (m ²)
Austria	330	52500	60	22100	4	2200
Belgium	345	61500	65	31900	6	3700
Bulgaria	265	32550	20	13700	2	1500
Croatia	160	19350	15	17500	1	1320
Cyprus	90	10800	15	11000	0	800
Czech Republic	450	31500	40	19200	2	1050
Denmark	680	36000	40	40300	5	3600
England	11500	772500	450	474500	25	24000
Estonia	135	13200	10	8100	1	1000
Finland	220	48750	35	83200	4	8900
France	8700	577500	270	305500	20	21000
Germany	13200	825000	410	409500	30	27900
Greece	330	41250	20	29900	2	2600
Hungary	260	30900	15	31900	1	2400
Ireland	350	43500	40	188500	2	10300
Italy	6500	201000	95	84500	7	5700
Latvia	160	30750	20	12800	0	300
Lithuania	220	50250	10	21000	0	2050
Luxembourg	115	15300	25	62400	3	5100
Malta	80	12900	10	11700	0	700
Netherlands	5600	210000	250	351000	15	15800
Poland	1600	70500	70	61100	3	2400
Portugal	275	33000	25	16900	2	1200
Romania	650	40500	30	17200	2	1200
Slovakia	260	34500	15	14600	0	640
Slovenia	140	15750	10	9700	0	700
Spain	6300	270000	100	136500	10	14600
Sweden	1300	48000	50	75400	5	8000
Total	60 215	3629250	2215	2562000	152	170660
<i>% of total</i>	<i>96,2</i>	<i>57</i>	<i>3,5</i>	<i>40</i>	<i>0,3</i>	<i>3</i>

Source: JRC, 2020, report on the development of EU GPP criteria for data centres, server rooms and cloud services⁶³

The large majority of data centres in the EU seem to be enterprise data centres (96%). If the white space is taken into account, it becomes clear, however, that colocation data centres are also important. Enterprise data centres occupy 57% of total white space, while colocation data centres occupy 40%. The average white space per type of data centre can be derived from the two tables: enterprise data centres have an average white space of 60m², colocation data centres of 1157m² and MSP data centres of 1123m².

⁶³ Dodd, N., Alfieri, F., Maya-Drysdale, L., Viegand, J., Flucker, S., Tozer, R., Whitehead, B., Wu, A., Brocklehurst F., Development of the EU Green Public Procurement (GPP) Criteria for Data Centres Server Rooms and Cloud Services, Final Technical Report., EUR 30251 EN, Publications Office of the European Union, Luxembourg, 2020, ISBN 978-92-76-19447-7, doi:10.2760/964841, JRC118558.

The above findings seem to diverge significantly from a worldwide survey conducted in 2018 and 2019⁶⁴ that shows only half of the companies that use data centres own and operate their own data centre. This can be derived from Figure 7 looking at the share of users of the in-source model (which seems equivalent to enterprise data centres). Again, inconsistency of definitions used might blur what is actually happening in reality.

Figure 7: Data Centre Delivery Model worldwide 2018-2019, in %

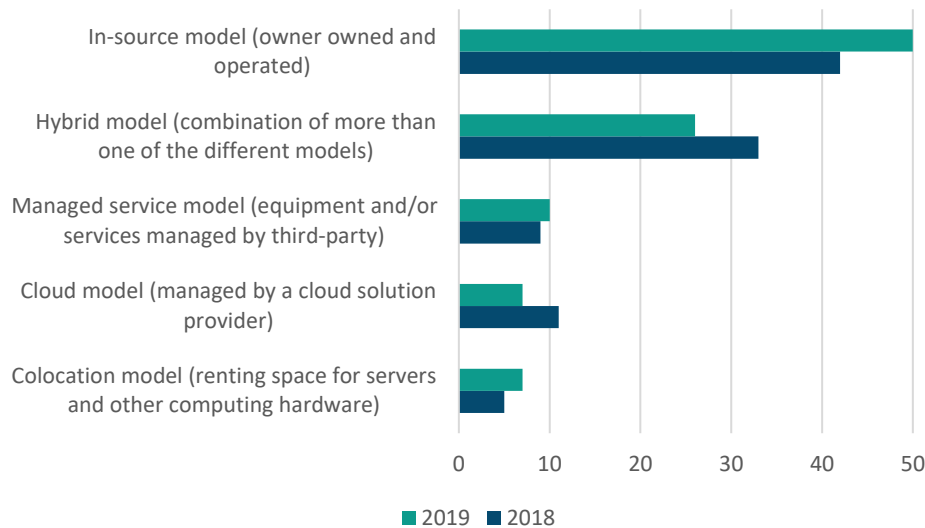

Source: Supermicro, 2019, Report on the State of the Green Data Center. N = 1362

In our survey to data centre operators, the operators were asked to indicate how many data centres of each type (enterprise, colocation or managed service provider) they operate and if they also operate data centres of another type. The distribution of the various types of data centres in our survey is shown in the figure below. Comparing this distribution to the one displayed in Table 7 reveals large differences indicating we should avoid generalising the results of our survey to the wider EU data centre population. Additionally, our survey respondents belong to the group of operators that operate larger data centres⁶⁵. Nonetheless, useful insights can be distilled from the survey.

A first insight from our survey results regarding classification by purpose, is that several operators mentioned hyperscale data centres as a separate category, next to enterprise, colocation or managed service providers' data centres. Another example of an additional type of data centres indicated by a respondent is a high performance computing data centre. The fact that both hyperscale data centres and high performance computing data centres are seen by some respondents as additional types of data centres is symptomatic of the lack of clarity of current definitions of enterprise, colocation and managed service provider data centres, as

⁶⁴ Supermicro, (2019), Data Centers & the Environment, 2019 Report on the State of the Green Data Center, p. 11.

⁶⁵ We base this conclusion on the average reported values of gross data hall white space (1540m²), total power (6.3MW) and the number of racks (1014).

these two types of data centres are in fact just a further specification of one of the three types based on scale or performance.

Figure 8: Number of data centres by purpose in the DC survey

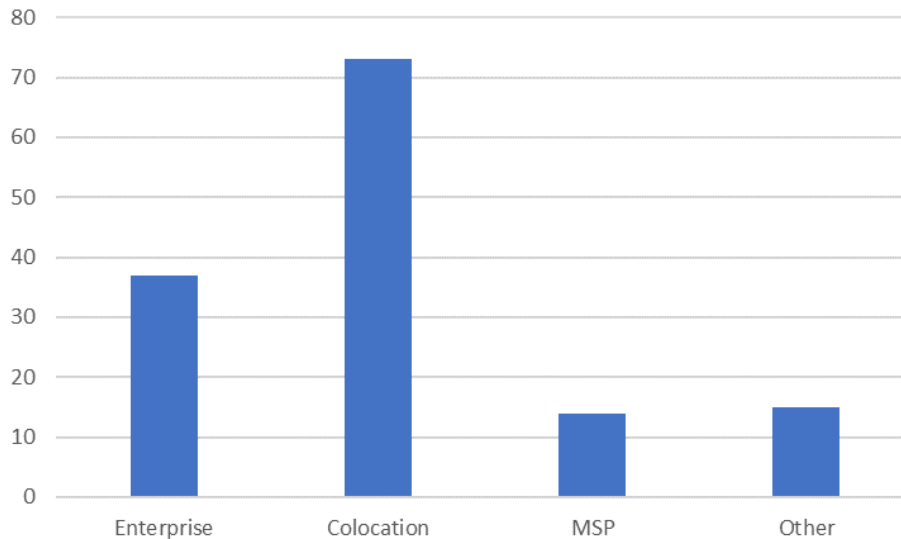

Source: IDEA Consult, Oeko-Institut, Visionary Analytics, 2021, Survey to data centre operators

Note: Other includes hyperscale, 'mini-enterprise' and high performance computing. N=15
Market share of public data centres in terms of size

In the EU funded EURECA project⁶⁶ more than 350 European public sector data centres were analysed. It was found that 80% of the public data centres are smaller than 25 racks, 17% hold between 25 and 125 racks and only 3% of public data centres have more than 125 racks. Moreover, the sizeable group of data centres with less than 25 racks runs older IT equipment. 40% of the servers used in this group are older than 5 years and produce only 7% of the computing capacity while accounting for 66% of energy consumption revealing a large waste of energy (cf. Figure 9). Furthermore, the facilities with the higher PUE values were typically the smaller facilities that are more difficult to make efficient due to small-scale IT and the age of the buildings. The PUE values of public sector data centres range from 1.5 to 7. Given the high energy waste in smaller facilities, from a policy perspective it is essential to target also smaller data centres with less than 25 racks when aiming for a greener data centre market. We should, however, be careful in generalising findings for public data centres to private data centres. As an example, we found in our survey the range of PUE values reported is much smaller (1.02-1.6), as is the average PUE value (1.28). Note, however, that the smallest data centre that reported its PUE counts 100 server racks.

⁶⁶ Expert and Stakeholder Consultation Workshop on Green ICT. CEF – Deployment Challenges and EU level Intervention (2020-2030). 30 January 2018. European Commission.

Figure 9: Server age distribution, energy consumption and compute capacity

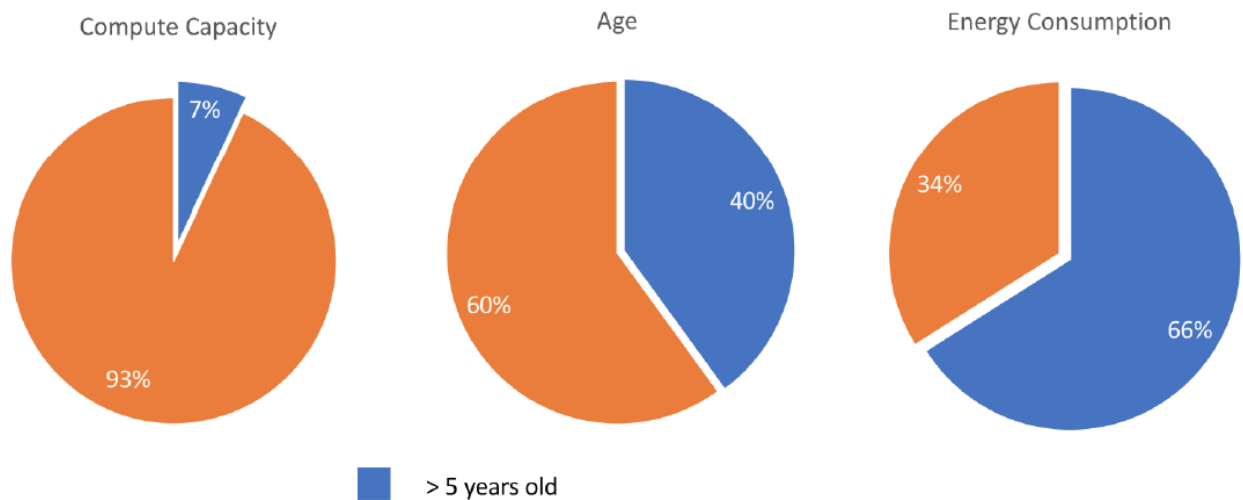

Source: Expert and Stakeholder Consultation Workshop on Green ICT. CEF – Deployment Challenges and EU level Intervention (2020-2030). 30 January 2018. European Commission, p.7.

Type of end-user

In our survey to data centre operators they were asked about the various categories of end-users that make use of their average data centre. In the figure below, average occupation rates of a data centre by type of end-users are shown.

Figure 10: End-users of data centres

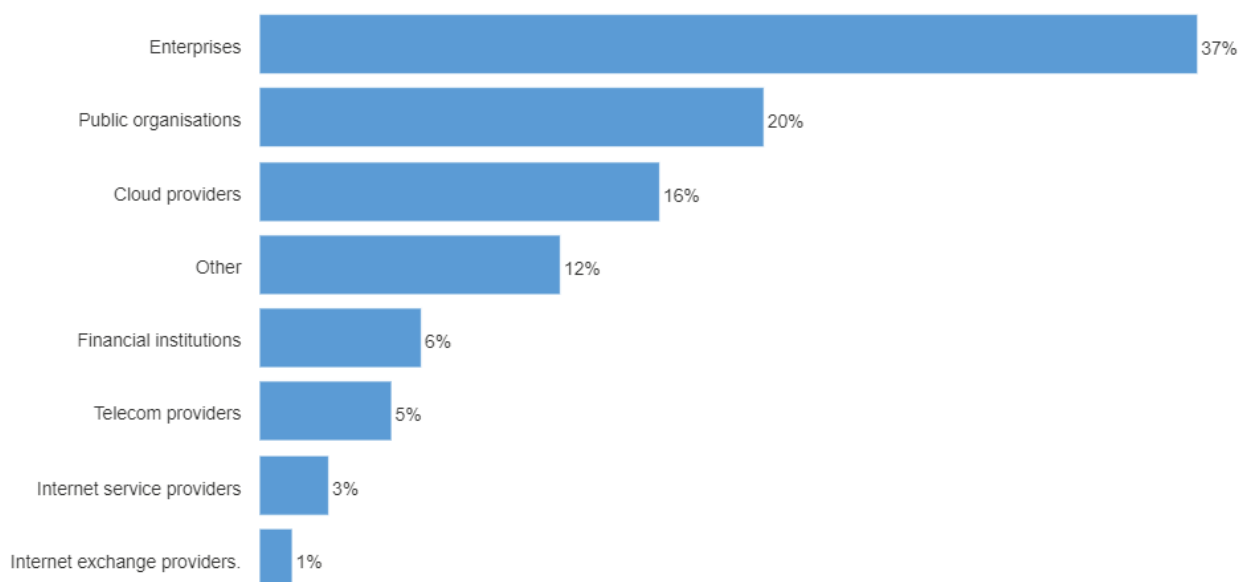

Source: IDEA Consult, Oeko-Institut, Visionary Analytics, 2021, Survey to data centre operators. N=12.

Not a single respondent indicated only one occupant in their average data centre. The largest group is constituted by enterprises, followed by public organisations and cloud providers. The most important lesson from this figure is that one should take into account the variety of end-users when formulating policy measures. At who will you aim them? And could there be differential effects depending on the type of end-user?

Data centre tiers

In the survey to data centre operators, they were asked to indicate to what tiers their average data centre belongs to. Three types of tiers were considered: tiers related to availability, protection and energy efficiency measurement granularity. With respect to availability 63% of the respondents indicated their average data centre is at Tier 3. 31% indicated their average data centre to belong to Tier 4. The remaining 6% are Tier 1 data centres. Strikingly, almost 60% of the respondents do not have a certificate that proves this. This observation is even stronger when we look at the two other types of tier classifications. Although all respondents indicate their data centres are protected against unauthorized access (best protected against), internal fire, external and internal environmental events (least protected against), only 40% have a certificate that proves this. Considering energy efficiency measurement granularity, of those that indicate to gather at least simple information for the entire data centre (level 1), 67% do not have a corresponding certificate.

Data centre operators that have certificates related to one or more tier systems were asked to provide the names of the organisations that provided the certificate. The organisations mentioned are: Uptime Institute, TÜViT, TÜV Rheinland, BSI, Socom and ISO.

Interview and survey input on market trends in the data centre sector

More specifically we focus on the reported general trends, insights on business performance and on the technological trends.

General trends

- Strong competition from the US and Asia: the EU share is decreasing.
- Knowledge/human capital is a big challenge: finding people with the right skills.
- Largescale public investment in digital infrastructure is insufficient.
- More attention towards energy efficiency and circular practices driven by client demands in addition to energy use from a cost perspective.

Business performance

- In the interviews it was stated turnover, employment, value added, etc. is expected to grow at an annual rate of more than 10% (double digit growth), further accelerated by the impact of covid (more e-commerce activities, homeworking, cashless payments, etc.).
- In the survey, the expectations were also positive, albeit a little more modest. More than 50% of the respondents believe turnover and annual investments will grow at an average rate of at least 6%. Almost 50% believe also that employment will grow at an average rate of more than 6%. Note that the group of respondents that expect a stable or even declining evolution is the largest for the employment indicator (29%).

Figure 11: Average annual growth predictions (time horizon: 5 years)

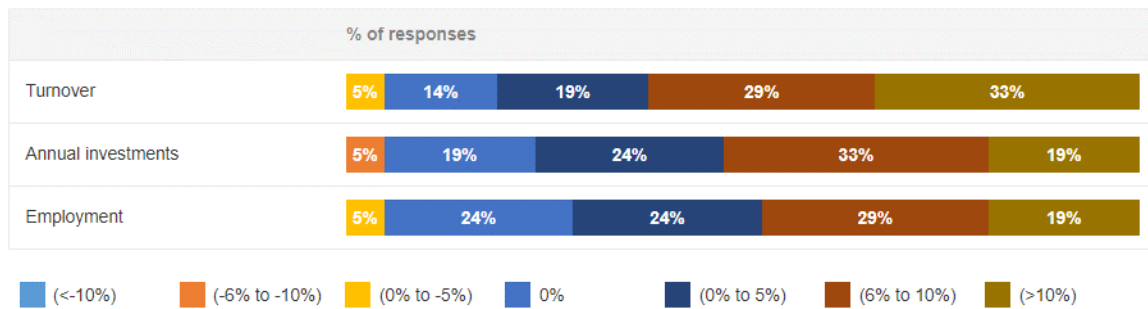

N 21

Source: IDEA Consult, Oeko-Institut, Visionary Analytics, 2021, Survey to data centre operators

Technological trends

- “Move to the cloud”: less enterprise data centres, more and more colocation with cloud services.
- More hyperscale data centres are emerging.
- At the same time the importance of edge computing is growing, hybrid configurations will remain important (potentially even be 50% of the market in the longer term). The data/application will determine where data is stored and processed.

Proposed set of definitions

Based on the previous steps, we are able to propose general guidelines to improve the definitions of data centres currently used.

- As the EN50600 standard is still being developed and is feeding through in other standards and is already widely known, the proposed set of definitions used should use the EN50600 definitions as a baseline for further refinement or clarification. The refined definitions should be included in EN50600 as this is the most efficient instrument to spread data centre definitions.
- A broad general definition of what constitutes a data centre is deemed necessary. The general EN50600 definition could therefore be modified in the spirit of what is proposed within the framework of the EURECA project. This definition is more inclined to also include smaller data centres due to the notion of controlled ambient conditions, instead of explicitly referring to cooling infrastructure: “A data centre is an environment hosting digital services, with power reliability equipment (UPS, Generators, power switches, PDUs, etc.) and controlled ambient conditions (cooling and humidity).” We propose to modify the EN50600 general definition as follows:
 - o “A structure, or group of structures, dedicated to the centralised accommodation, interconnection and operation of information technology and network telecommunications equipment providing data storage, processing and transport services with power reliability equipment (UPS, Generators, power switches, PDUs, etc.) and controlled ambient conditions (cooling and humidity).”

humidity) together with the necessary levels of resilience and security required to provide the desired service availability”.

- The current EN50600 category definitions of data centres, categorized according to purpose is not clear enough and causes confusion and overlap. Even the term ‘purpose’ is unclear (one could also indicate for example bitcoin mining as a purpose or high performance computing).
 - o It would be beneficial to clearly indicate how the various category definitions relate to each other. A suggestion we obtained during one of the interviews was to look at who ‘owns’ what within a data centre (e.g. building, support infrastructure, IT-equipment) and who determines the applications. This should be elaborated in each of the definitions to avoid confusion. This idea is visualised in the figure below.

Figure 12: Ownership based data centre definition

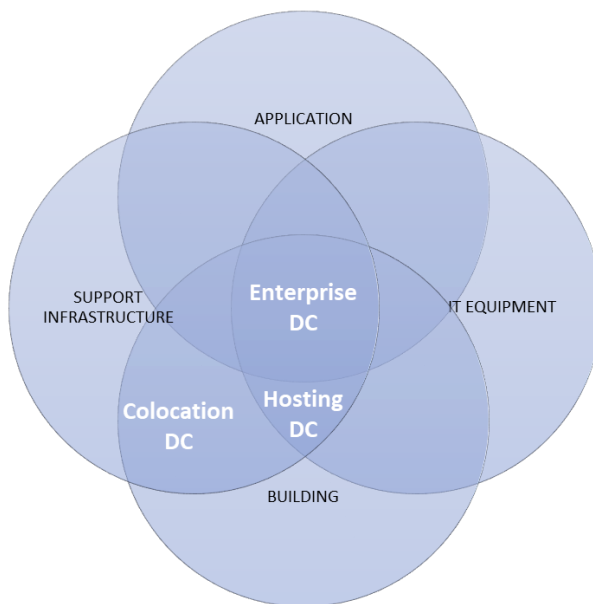

Source: IDEA Consult, based on input acquired during an interview with Rabih Bashroush (Uptime/EURECA).

More specifically, to the definitions of the existing data centre types mentioned in EN50600 (except for Network Operator Data Centres which is defined at a different level), the following extensions could be added:

- Enterprise data centre: one organisation owns the building, support infrastructure and IT equipment, and determines its own applications.
- Colocation data centre: an organisation owns the building and support infrastructure, but the IT equipment and software is determined by its users.

- Hosting data centre: an organisation owns the building, support infrastructure, and IT equipment but the software is determined by its users.

Furthermore, we propose to explicitly add the hybrid data centre type to account for the data centres that do not fall within one of the definitions listed above.

- Hybrid data centre: e.g. an organisation owns building and support infrastructure and part of the IT equipment, while another part of the IT equipment is owned by its users.
- From a policy perspective, irrespective of the specific definitions or labels used, it is of the highest importance to be aware of the distinction between who owns and/or operates (who is responsible for) which parts of the data centre (building, support infrastructure, IT equipment, application layer) in order to determine who should be the target of policy measures. To do this one could use an ‘applicability matrix’ with the various parts of the data centre listed in rows and who owns it and operates it in two separate columns as illustrated in Table 8.

Table 8: Application matrix for analysing ownership and operation across layers of DCs

Data centre layer	Owned by:	Operated by:
Building	xxxx	xxxx
Support infrastructure	xxxx	xxxx
IT equipment	xxxx	xxxx
Application layer	xxxx	xxxx

Source: IDEA Consult

- The interpretation of a Managed Service Provider data centre versus hosting data centre is not clear. Also, managed services can be interpreted in numerous ways: management of the building, management of the equipment, etc. To avoid further confusion, the use of a Managed Service Provider data centre as a separate category of data centres should be avoided.
- Cloud service providers offer cloud services in all types of data centres, sometimes they own the data centre, sometimes they don't. What is typically referred to as a cloud data centre is therefore confusing as it suggests it is one specific type of data centre: a very large enterprise data centre owned by a well-known public cloud provider. In our opinion, a cloud data centre can be defined as any data centre that is primarily used for the provision of cloud services (Infrastructure-as-a-service, Platform-as-a-service, Software-as-a-service, or a mixture of those).
- Based on desk research and interviews, the best size criteria based on ease of use for the reporting organisation are floor size followed by number of racks. We found, however, that the most consistently reported thresholds were based on total power capacity. Below, several size categories are presented. The number of racks is

obtained using total power capacity as a starting point and an average rack power consumption of 5kW and should only be seen as indicative: in reality there is a lot of variety in power capacity per rack and the power density is rising. We believe that, from a policy perspective, more relevant than the thresholds themselves are the elements of a data centre that change when it gets larger, e.g. use of automation, redundant components, modularity, etc.

Table 9: Criteria and thresholds for dividing data centres according to size class (small, large, hyperscale)

	Small deployment	Large deployment	Hyperscale deployment
Floor size	100 m ² - 1000 m ²	1000 m ² - 10.000 m ²	more than 10.000 m ²
Number of racks	6 to 200	200 to 2000	2000+
Power capacity	50kW – 1 MW	1MW – 10MW	10MW+

Source: IDEA Consult

Task 1.1.2: Research current market practices for circularity of data centre hardware

Aim of this task

The aim of this task is to provide an overview of market practices on maintenance, re-use, refurbishment, re-manufacturing as well as links to secondary markets for IT hardware used in data centres as well as metrics linked to performances in these areas. Additionally, suggestions are put forward on how to increase data centre hardware circularity based on state of the art examples from leading data centre operating companies. Finally, these inputs inform potential policy options and recommendations on relevant indicators towards increasing circularity practices and finally closing the loop on related material resources.

Current trends and scope of circularity for data centre hardware

A prevalent definition of circularity for data centres is a data centre which “... *is designed for disassembly, each connection of the data centre can be taken apart and each component can be refurbished, reused, recycled with zero waste and remade into a new material to give rise to a circular economic growth.*”⁶⁷

⁶⁷ Kass, S. (2020) “The cleanest data centres are the ones that aren’t built at all.” Accessed January 2021 from <https://www.cloudexpo.eu/news/circulareconomy-sustainable-datacenter>

Figure 13: Circular Economy for Data Centre Lifecycle

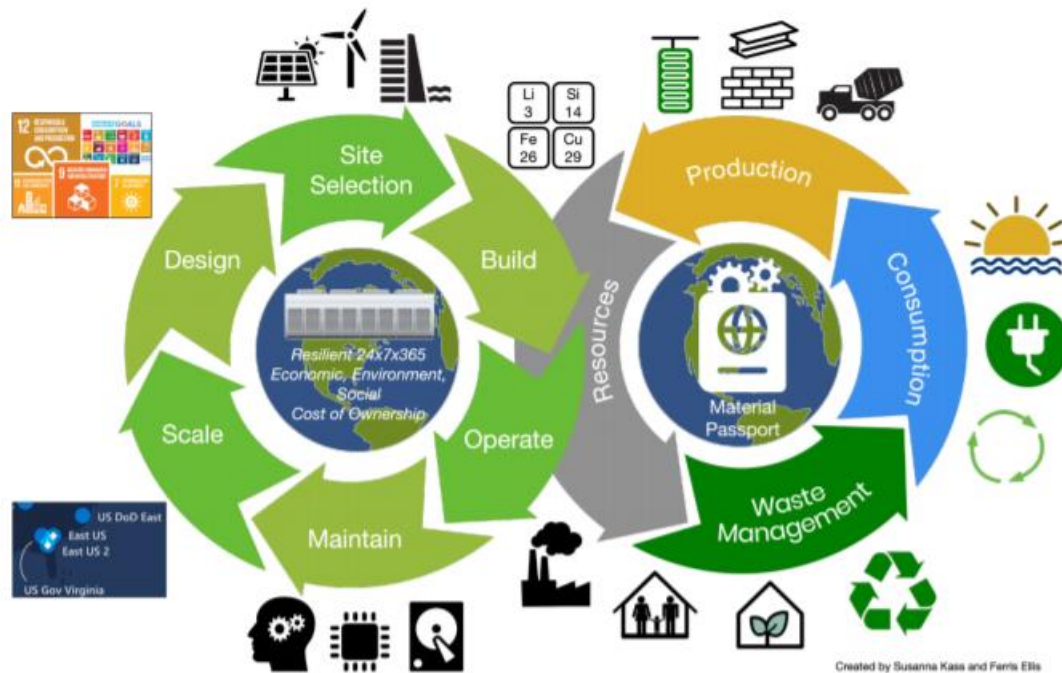

Source: Kass, S., Salama, A., 2020

Between 2015 and 2020, servers' lifetime in data centres before being replaced or refurbished has increased. Of 220 data centre managers surveyed worldwide in 2015, 37% indicated to refresh their servers every three years, while in 2020, 31% indicated to refresh them every five years. A further 19% of 418 managers surveyed in 2020 even indicated to extend the use time beyond five years. These figures converge also with the 2018 EURECA study which surveyed 300 data centres in Europe and found that 40% of deployed servers were older than 5 years. These old servers required 66% of all energy consumed by the facility centres while only contributing to 7% of the overall computing capacity.⁶⁸

Over time, the hardware refresh cycle has succumbed to the slowing down of Moore's Law, namely the fact that transistor capacity is not doubling every two years as was the case for close to 20 years.⁶⁹ Between 2015 and 2020 Intel and AMD have struggled to maintain the pace of improvement which practically means that hardware doesn't need to be replaced as often, since its computing power stays up to date for a longer period of time with Moore's Law slowing down.⁷⁰ This means that components remain up to date and cutting edge for longer, making refresh cycles longer and reducing electronic waste. In this sense one could argue

⁶⁸ European Commission H2020 DC EURECA Project – Final Project Report. April 2018.

⁶⁹ Bashroush, R., Lawrence, A., (2020), Beyond PUE: Tackling IT's wasted terawatts, Uptime Institute, p. 14

⁷⁰ Ascierio, R., Lawrence, A., (2020), Uptime Institute global data center survey 2020, Uptime Institute

that ICT progress is inversely connected to circularity and maintaining equipment becomes not only more environmentally sustainable but also more cost-effective.

Figure 14: Data centre server refresh cycles, 2015 versus 2020

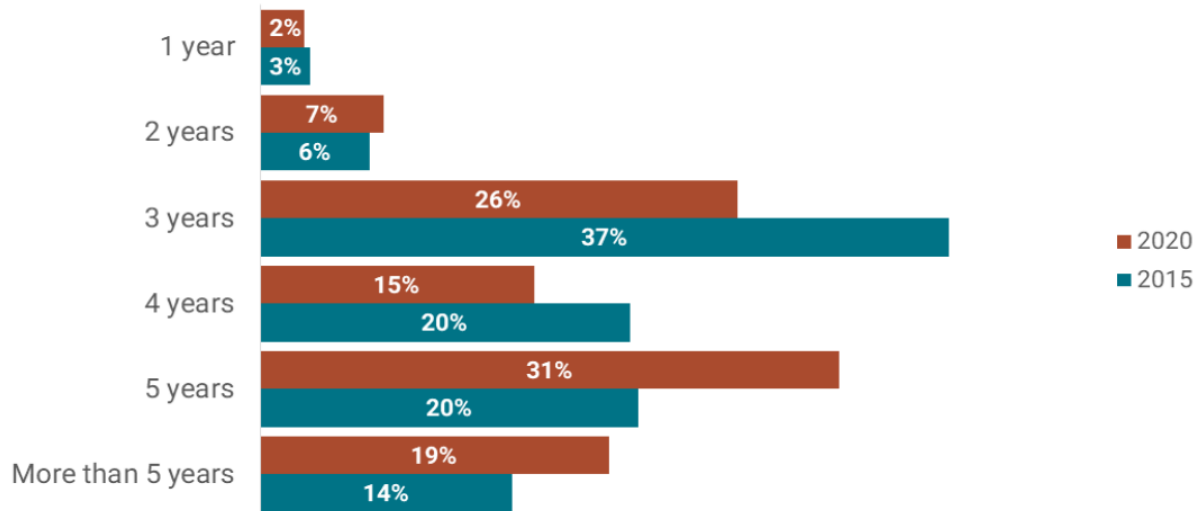

How often does your organization typically refresh servers? Choose one.

Source: Uptime Institute Global Survey of IT and Data Center Managers 2015 (n=220) and 2020 (n=418)

Total e-waste in 2019 was around 12 million metric tons in Europe. Asia is the region generating the most e-waste with 24.9 million metric tonnes while the Americas follow with 13.1. Even if the bulk of the generated e-waste is likely to come from private consumption, increasing data centre capacity in recent years and in the foreseeable future leads to increasing e-waste over time.⁷¹

The leading companies worldwide to manufacture, test and install servers in data centres are Dell, IBM, HPE, Inspur and Lenovo.⁷² These companies manufacture servers and server components and deliver them to data centres. Some private companies running hyperscale data centres have however started researching and designing their own custom ARM-based chips. The most recent example is Apple releasing its M1 chip which according to the company has a 3.5 times higher CPU performance and 15 times higher machine learning performance than traditional chips. This is a key development as larger players are able to manufacture hardware for their own data centres according to their own desired specifications without the

⁷¹ Hinchliffe, D., Gunsilius, E., Wagner, M., Hemkhaus, M., Batteiger, A., Rabbow, E., Radulovic, V., Cheng, C., Fautereau, B., Ott, D., Kumar Awasthi, A., Smith, E., (2020), Partnerships between the informal and the formal sector for sustainable e-waste management, The Solving the E-waste Problem Initiative (StEP), consulted online: https://www.step-initiative.org/files/_documents/publications/Partnerships-between-the-informal-and-the-formal-sector-for-sustainable-e-waste-management.pdf

⁷² Weloop, (2019), A Situational Analysis of a Circular Economy in the Data Centre Industry , p. 20, consulted online: http://weloop.org/wp-content/uploads/2020_04_16_CEDaCI_situation_analysis_circular_economy_report_VF.pdf

need to reach out to independent manufacturers.⁷³ This trend has however also a negative effect on the industry's potential for circularity as hardware manufacturers' activities become more fragmented making it harder to coordinate monitoring or gain an overview of current practices.

The individual components of data centres that are subject to the analysis of potential circularity practices are listed in Table 10 together with an overview of their average lifespan. The components to be replaced most frequently (average lifespan of 3-8 years) are batteries, servers, storage equipment, and network equipment. These components also pose the biggest challenge as they constitute a significant contribution to electronic waste. Other components of which the life expectancy can reach up to 20 years are typically not technology-intensive and tied to progress. These are usually components necessary for power generation, cooling systems, security systems and the building infrastructure itself. Therefore it is relevant to prioritise components with short life spans for circularity considerations

Table 10: Main components of a data centre facility (Garnier, 2012)

	Data centre equipment	Lifespan (Years)
Power generation	Uninterruptible power supply (UPS)	20
	Transformers	20
	Switchgear	20
	Backup generators	20
	Power distribution units (PDUs)	20
	Batteries	3-5
	Power cables	20
IT	Servers	3-8
	Storage equipment	3-5
	Network equipment (switches, routers, etc.)	3-5
	Chassis	20
	Network cables	10
Cooling system	Chillers	20
	Computer room air conditioning units (CRACs)	20
	The direct expansion air handler	20
	Pumps	20
	Cooling towers	20
	Heat exchange systems	20
	Reservoir storages for collecting rainwater	20
Security system	Fire-suppression system	20
	Video-cameras	20
Building structure	Lighting, infrastructure, etc.	20

Source: Weloop, 2020, consulted online: http://weloop.org/wp-content/uploads/2020_04_16_CEDaCI_situation_analysis_circular_economy_report_VF.pdf

⁷³ See online: <https://www.apple.com/mac/ml/>

Circularity practices for IT equipment surrounding data centres

This section presents current circularity practices of data centre hardware. The practices presented in this section can be summarised as follows: Adhering to standards and certifications

- Implementing KPIs on performance, energy and water consumption and thresholds on emissions;
- Maintaining hardware;
- Refurbishing and reusing hardware;
- Collaborating with secondary markets;
- Recycling hardware components;
- Repurposing hardware within the business.

From a regulatory point of view, many certifications and standards exist imposing or suggesting circularity practices for data centres. ISO 50001 and EN 50600 relating to energy usage are relatively new, having been issued in 2018 and 2016 respectively.

The German Data Centre Association released a comprehensive study on data centres and some key circularity aspects in 2020.⁷⁴ This type of report is relatively unique in Europe in terms of it being very recent and covering a lot of different aspects. Germany is an important hub for Data Centre development and the report therefore indicative for key industry developments. According to their survey, ISO 14001 relating to the environment is held by 14% of data centres in Germany, specifically.⁷⁵ While these standards apply to data centres in the broader sense, sub-section CLC/TR 50600-99-1 and 50600-99-2 of the European standards directly relates to the data centre hardware and its potential for circularity. The 2019 European EcoDesign Legislation for servers and storage devices further imposes practices for the circular design, use and disposal of IT equipment.⁷⁶ The following table highlights the main standards and certifications European data centres are subject to.

⁷⁴ Consulted online: <https://www.germandatacenters.com/de/themen/data-center-outlook-2021-big-data-big-business/>

⁷⁵ German Data Centre Association, (2020), Data Center Outlook 2021, consulted online: <https://www.germandatacenters.com/de/themen/data-center-outlook-2021-big-data-big-business/> , p. 27

⁷⁶ European Commission, (2019), laying down ecodesign requirements for servers and data storage products pursuant to Directive 2009/125/EC of the European Parliament and of the Council and amending Commission Regulation (EU) No 617/2013, Commission Regulation (EU) 2019/424.

Table 11: Certifications and standards for data centres' circularity practices related to hardware, applicable in Europe⁷⁷

CLC/TR 50600-99-1	Information technology: Data centre facilities and infrastructures - Part 99-1: Recommended practices for energy management
CLC/TR 50600-99-2	Information technology: Data centre facilities and infrastructures - Part 99-2: Recommended practices for environmental sustainability
ETSI EN 300 019 series	Environmental conditions and environmental tests for telecommunications equipment
ETSI TS 105174-2	Access, Terminals, Transmission and Multiplexing (ATTM); Broadband Deployment - Energy Efficiency and Key Performance Indicators; Part 2: ICT sites
ETSI EN 305 174-2	Access, Terminals, Transmission and Multiplexing (ATTM); Broadband Deployment and Lifecycle Resource Management; ICT Sites
ETSI EN 305 174-8	Access, Terminals, Transmission and Multiplexing (ATTM); Broadband Deployment and Lifecycle Resource Management; Part 8: Management of end of life of ICT equipment (ICT waste/end of life)
EU CoC BP	Best Practices for the EU Code of Conduct on Data Centres
ITU-T L.1300	Series L: Construction, Installation and Protection of cables and other elements of outside plant: Best practices for data centres
ISO 14001	Defines the criteria for an environmental management system. It provides a framework that companies or organisations can apply to implement an effective environmental management system.
ISO 50001	Energy-related performance and relevant systems for companies
ISO/IEC TR 30133	Information technology – Data centres – Guidelines for resource efficient data centres

Source: IDEA Consult, adapted from CEN/CENELEC/ETSI, 2018

In order to assess the energy efficiency of IT equipment, the PUE rate, as indicated in previous sections, is a problematic indicator as increasingly efficient IT equipment and stagnating building efficiency result in a poorer PUE. The relevance of PUE for energy efficiency and circularity of equipment for that matter is relatively limited. Therefore, it is advisable to monitor other metrics simultaneously, such as Water Usage Effectiveness (WUE) which would give an indication on the environmental footprint of the water used to maintain IT equipment at stable temperatures.⁷⁸

In addition to PUE used as a main indicator for measuring **circularity in data centres overall**, other indicators mentioned by data centres during our survey include heat circularity, building

⁷⁷ CEN/CENELEC/ETSI, (2018), Energy Management and Environmental Viability of Data Centres.

⁷⁸ Kass, S., Ramakrishnav, S., (2020), The Impact of the Circular Economy to the Data Center and ICT Sector White Paper, consulted online: <https://static1.squarespace.com/static/5dd2a05acb3ab6681a6ec4b5/t/5e9f7562806be7625483ab19/1587508582997/Impact+Of+Circular+Economy+to+Data+Center+and+ICT+Sector+DCD.pdf>

design density, embodied carbon emissions, network usage effectiveness and share of refurbished inventory. When asked what **metrics related to the IT equipment data centre operators were actively working on improving**, the most popular was maintenance, followed by reuse, refurbishment, exchange with secondary markets for components and materials and finally remanufacturing.

For the IT equipment itself, the circularity consideration starts necessarily with the first use of the equipment as operators need to have a strategy in place for maintaining, replacing and renewing their equipment. During our interviews with national data centre associations it was highlighted that smaller data centre operators resolve to purchase cheap and fast IT equipment because they are under pressure from their clients and they do not have the financial resources and scale to invest into programs dedicated to refurbishing and updating their hardware. Large operators and hyperscalers especially on the other hand do have the resources and the financial incentive to develop large scale programmes with the purpose of updating the hardware.

The most relevant metric in the data centre industry for applying circularity practices for IT equipment is scale. Large data centres are capable of increasing their efficiency, optimise refreshment cycles, maximise computing power and rationalise floor space. Small data centres on the other hand are restricted in their capability of addressing these challenges. The large majority of data centres are relatively small, running less than 25 racks.⁷⁹ These are either individual companies with their own server rooms or even colocation data centres, which added up require a very large floor space for on average poor circularity performance. Survey respondents indicated that the most limiting factors in extending the useful lifetime of data centres' IT equipment were technology and cost concerns. Consolidating data centres infrastructure into larger, more efficient data centres reduces the overall floor space required, but also enables implementation of other circularity aspects mentioned above.

Implementing circular practices in data centres requires large investments. Operators of hyperscale data centres and especially the Internet Big Five (Amazon, Apple, Facebook, Google and Microsoft)⁸⁰, who run the largest data centres, have the financial means at their disposal to establish and run programmes for circularity and max out the lifetime and efficiency of their equipment. In contrast and as indicated earlier, small operators and especially companies with only a few servers typically consider the cost of acquisition and server speed as primary metrics when establishing their data centres. Therefore they tend to use their assets until they completely break down, at the expense of energy and processing efficiency. Other reasons for operators to not employ recycling practices for their hardware include a too time-consuming process, the difficulty of finding certified partners for material recycling and a simple lack of e-waste management planning.⁸¹

The following graph visualises how data centres operators and IT practitioners worldwide handled outdated data centres server hardware in 2018 and 2019. Over 1000 IT managers

⁷⁹ Bashroush, R., (2020), Lawrence, A. Beyond PUE: Tackling IT's wasted terawatts, Uptime Institute, p. 19

⁸⁰ Also commonly known under the acronym GAFAM

⁸¹ Information from interviews with national data centre associations

were surveyed.⁸² While 4% more operators repurposed outdated hardware within their business in 2019 than in 2018, 14% fewer operators partnered with certified electronics recycling companies in the same timeframe.⁸³ These findings converge with the survey we conducted with data centre operators and further point towards a difficulty of finding certified electronics recycling companies as partners, but also a trend of product life extension within data centres.

Figure 15: Methods of handling outdated data centre server hardware worldwide 2018-2019, in %

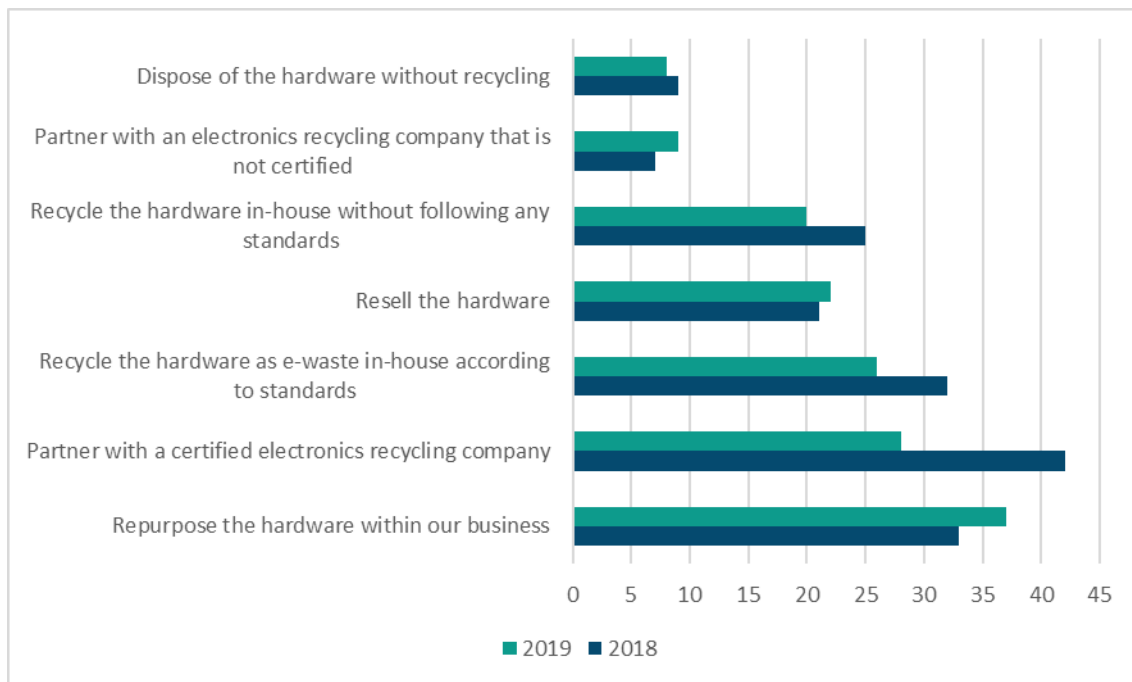

Source: Supermicro, 2019, Report on the State of the Green Data Center. N = 1362

For a circular system, the hardware used in data centres can be analysed under the 10 Rs addressing circularity of any given industry. These are illustrated in the following table.

⁸² Supermicro, (2019), Data Centers & the Environment, 2019 Report on the State of the Green Data Center.

⁸³ Supermicro, (2019), Data Centers & the Environment, 2019 Report on the State of the Green Data Center, p. 10.

Table 12: The 10R framework for guiding and identifying potential policy suggestions for increasing data centre hardware circularity

2 distinct product life cycles: Value retention options R0 – R9:	Life Cycle 1: Product Produce and Use Life Cycle		Life cycle 2: Product Concept and Design Life Cycle	unspecified general word use (to be further avoided)
	consumers	producers/retailers	designers	
Short loops: R0-3				
Refuse: R0	- choice to buy less, or use less; - reject packaging waste and shopping bags	n.a.	- refuse the use of specific hazardous materials or any virgin material; - design production processes to avoid waste	
Reduce: R1	- using purchased products less frequently; - use them with more care and longer.	n.a.	- as explicit steps in product design: - using less material per unit of production; - or 'dematerialization'	'eliminating waste, not dispose anymore' 'as for all user steps'
Resell/Re-use: R2	- buying second hand, or finding a buyer for a product that was not or hardly in use, possibly after some cleaning or minor adaptations restoration; - use online consumer-to-consumer auctions for used products	- 'direct re-use' as economic activity via collectors and retailers, possibly with quality inspections, cleaning and small repairs; (commercial and non-commercial); - 'direct re-use' of unsold returns or products with damaged packaging; - multiple re-uses of (transport) packaging	- 're-use in fabrication' - apply recycled materials	
Repair: R3	- by the consumer in their vicinity, or at their location, or through a repair company; - or at a 'repair café'	- send collected products to their own repair centers, to manufacturer-controlled, or to third party repair centers; - distinguish 'planned repair' as part of a longer lasting maintenance plan from 'ad-hoc' repairs	- enable easy repairing	confused with 'refurbishment'
Medium Long Loops: R4-6				
Refurbish: R4	n.a.	- overall structure of large multi-component product remains intact, while many components are replaced or repaired, resulting in an overall 'upgrade' of quality of product - Examples: buildings, airplanes, trains, mining shovels		
Remanufacture: R5	n.a.	- full structure of a multi-component product is disassembled, checked, cleaned and when necessary replaced or repaired in an industrial process, recycled parts may be used - expected retained quality more tempered: 'up to original state, like new'		some also refer to this as 'reconditioning', 'reprocessing' or 'restoration': better avoid
Repurpose: R6	n.a.		- reusing discarded goods or components adapted for another function:	some use: 'rethink' or 'fashion upgrading': better avoid
Long Loops R7-9				
Recycle Materials: R7	- give back as separate waste streams	- processing of mixed streams of post-consumer products or post-producer waste streams using expensive technological equipment, including shredding, melting and other processes to capture (nearly) pure materials;	- apply recycled materials	'recycle' is frequently and confusingly use to cover all alternatives: better avoid
Recover (energy): R8	n.a.	capturing energy embodied in waste, linking it to incineration in combination with producing energy, distilled water or use of biomass	n.a.	'recover' often used as equivalent for general recycling: better avoid
Re-mine (R9)	n.a.	- retrieval of materials after the landfilling phase: - 'cannibalization'; - hi-tech landfill mining or urban mining	- apply recycled materials	

Source: Reike et al., 2018; Vermeulen W.J.V., Reike D., & Witjes D. (2018). *Circular Economy 3.0: Getting Beyond the Messy Conceptualization of Circularity and the 3R'S, 4R'S and More* Retrieved from https://www.cec4europe.eu/wp-content/uploads/2018/09/Chapter-1.4_W.J.V.-Vermeulen-et-al_Circular-Economy-3.0-getting-beyond-the-messy-conceptualization-of-circularity-and-the-3Rs-4Rs-and-more.pdf

Some of the current circularity practices for data centres can be boiled down to the following:⁸⁴

- **Rack power density**

The density at which server racks are packed influences the floorspace needed to host the hardware and consequently the energy required to cool the racks. Switching to

⁸⁴ Brown, E., (2013), Electronics Disposal Efficiency (EDE): an IT Recycling Metric for Enterprises and Data Centres, The Green Grid, consulted online: <https://www.thegreengrid.org/en/resources/library-and-tools/235-WP>

multi-node and blade systems that share fans and power supplies leads efficiency gains of 10 to 20% as well as requiring less equipment for the same capacity.⁸⁵

- **Whole system reuse**

Under whole system reuse can be considered that the entire IT equipment is being maintained, reused and refurbished.

- **Partial system reuse - parts and components reuse**

This practice relates to the ongoing maintenance of data centre equipment, in which servers are monitored, faulty components replaced and the overall servers refurbished. This occurs when the servers are faulty, or significant increases in energy use are noted. Depending on the manufacturing date of individual components, data centres may decide to replace still functional components with newer ones because they are more efficient, faster or have a higher data storage.

- **Remanufacturing**

Remanufacturing typically starts with the shredding, crushing or degaussing of components in order to start the material separation process from which new equipment can be manufactured.

When data centre operators decide to refurbish their IT equipment, they sometimes enter the secondary market, aiming to reduce losses and sell their previous equipment to brokers and remanufacturers. The remanufacturing process consists of the following steps:⁸⁶

⁸⁵ Malyala, V., (2020), Are data centres destroying the environment?, Data Centre Review, consulted online: <https://datacentreview.com/2020/06/are-data-centres-destroying-the-environment/>

⁸⁶ http://weloop.org/wp-content/uploads/2020_04_16_CEDaCI_situation_analysis_circular_economy_report_VF.pdf

Figure 16: Remanufacturing steps of data centre hardware

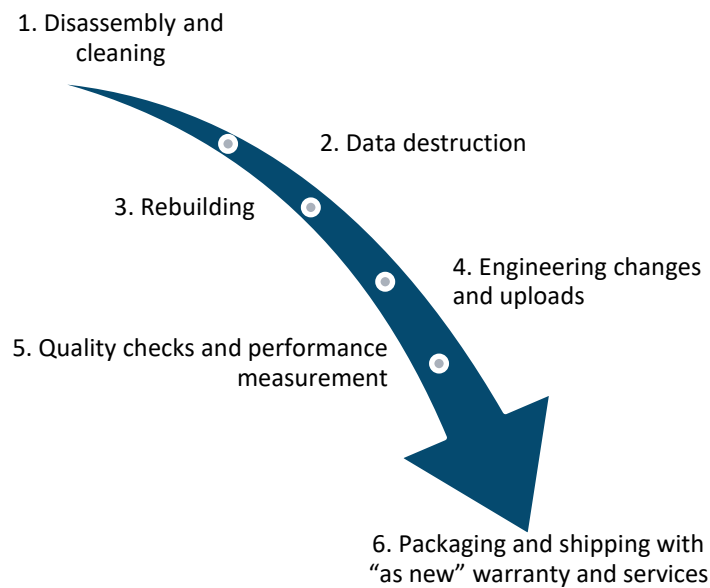

Source: IDEA Consult, based on WeLoop, 2020

- **Recycling**

In accordance with the WEEE Directive 2012 when individual components or servers reach their end of life they are classified into two distinct categories.

- Category 4: Large equipment: any dimension larger than 50cm
- Category 6: Small IT and telecommunication equipment

Recycling of hardware components feeds into the more general topic of WEEE recycling. Decommissioned servers or components are sent by data centre operators or their providers to dedicated recycling plants. These receive WEEE from different sources and separate toxic waste from reusable materials such as plastics and ferrous and non-ferrous metals.

The electronic and electrical equipment used in data centres consists of components that are made of metals such as aluminium, copper, steel and gold, plastics and ceramics. The current Critical Raw Material (CRM) recycling rate in Europe lies around 1%.⁸⁷

- **Reporting**

Data centre operators report different metrics relating to the circularity of their hardware because of lacking regulation and standardisation. The available data on European level is missing, however some national associations and individual operators to

⁸⁷ WRAP, EARN, Wuppertal Institute, Innovate UK, and European Recycling Platform, "Critical Raw Material Closed Loop Recovery," Growth, 2019

provide data. Some of the metrics representative of the circularity of data centre hardware are:

- Percentage of used electronics refurbished
- Percentage of used electronics resold
- Percentage of used electronics recycled
- Percentage of used electronics landfilled
- Percentage of used electronics incinerated (as treatment and for waste energy)

Box 2: Facebook business case example for data centre circularity practices⁸⁸

Facebook deployed a machine learning model to monitor, predict and optimise the efficiency of their data centre operations. Such a model not only makes it possible to identify current potential for improvement, but also how data centre operations can be adapted in the medium term future. This implies energy use, but also **equipment design, use and maintenance**. The model allows Facebook to reduce the number of servers that need to be on during low-traffic hours, resulting in power savings of 10 to 15% and reduced wear on the equipment.

Facebook data centre buildings are LEED (Leadership in energy and Environmental Design) certified, applying principles of systems and design thinking in order to take advantage of circularity potential across all relevant value chains, mainly related to material and energy sourcing. Systems thinking further incentivises material innovation. Looking for **alternative materials with a lower carbon footprint**, Facebook developed mechanical parts for their servers made out of natural fibre-filled polypropylene (NFFPP).

Integrating life-cycle thinking into the design process of data centre hardware, Facebook employs a range of partners that allow them to connect to **secondary markets** for their equipment as well as have decommissioned servers and components recycled by certified companies.

The most straightforward way to increase the environmental sustainability of data centres is to **increase server utilisation**. This would rationalise the amount of hardware manufactured and put into use, effectively reducing electronic waste. With an average utilisation rate of 25% only, there are gains to be explored. It should be noted, however, that server utilisation rates have an optimum, balancing the effectiveness of server use and not overloading them. Therefore utilisation should remain below 50% in order to allow for failovers, comply with manufacturers' recommendations and reserve capacity for peak demand instances. The configuration of key-server components plays a further role in the potential for utilisation increase.⁸⁹

⁸⁸ Facebook, (2020), consulted online: <https://sustainability.fb.com/innovation-for-our-world/sustainable-data-centers/>

⁸⁹ Bashroush, R., (2020), Lawrence, A. Beyond PUE: Tackling IT's wasted terawatts, Uptime Institute, p. 12

In Germany only 18% of data centres use more than 50% of the waste heat they generate in 2020 and only one in 10 data centres plan to do so in the future.⁹⁰ The Dutch Data Center Association estimates that if all the heat generated by data centres were consumed, it could heat more than one million homes and save up 600 kilotons of CO₂ emissions.⁹¹ Figure 17 illustrates how data centres could potentially be connected to an energy grid to heat homes and receive cooling in return. This ties into the concept of industrial symbiosis, which provides the opportunity for using waste heat in industrial and private applications that are in close proximity. In order to facilitate data centres in valorising their waste heat, the regulatory framework for construction and maintenance as well as technological capabilities need to be updated in order to ultimately **increase the use of waste heat**.

Figure 17: Connecting data centres to a green energy grid for waste heat valorisation (Example for the Netherlands)

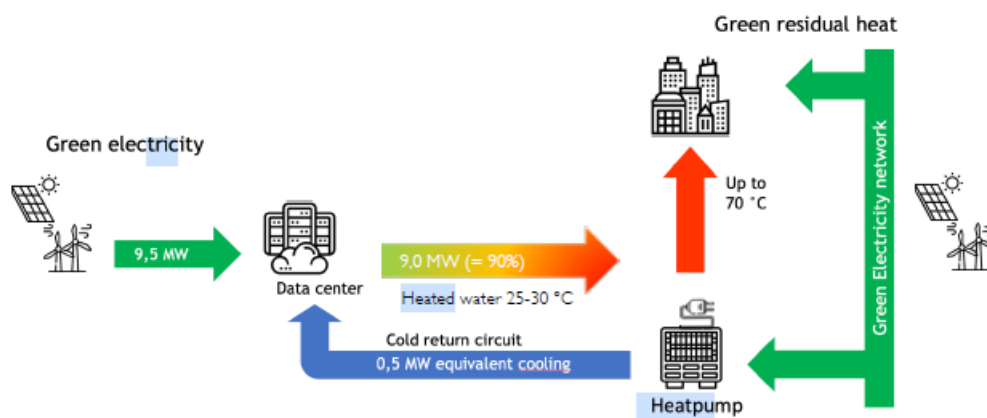

Source: Dutch Data Center Association, 2020

Considering that 40% of servers in data centres older than 5 years required 66% of all energy consumed by the facility centres while only contributing to 7% of the overall computing capacity points to a significant **potential for energy efficiency improvements**, but also **gains in computing power in data centres**. Additionally, **consolidating data centres infrastructure** into larger, more efficient data centres reduces the overall floor space required.

In the following sections we further explore practices around maintenance, reuse, refurbishment and remanufacturing as well as emerging and future practices.

Maintenance, reuse, refurbishment, remanufacturing

In German data centres the PUE rate ranges from 1.05 to 2.20 with an average of 1.38. As indicated in section 1.3, the PUE has globally been decreasing by 0.75 points between 2010 and 2018, indicating that data centres are becoming more efficient overall. There is an important barrier when aiming to significantly improve the PUE. Namely, cheap and effective

⁹⁰ German Data Center Association, (2020), Data Center Outlook 2021, consulted online: <https://www.germandatacenters.com/de/themen/data-center-outlook-2021-big-data-big-business/>, p. 30

⁹¹ Dutch Data Center Association, (2020), State of Dutch Data Centers, p. 19

energy efficiency measures can be undertaken with relative ease, while structural improvements beyond that require large investments.⁹²

The US-based non-profit organisation The Green Grid proposes the **Electronics Disposal Efficiency (EDE)** metric, designed to measure how successfully outdated IT equipment is managed. This metric measures the share of IT equipment that is being disposed of properly in total disposed of IT equipment by weight. The Green Grid considers that IT equipment is only being disposed of responsibly if done by an organisation that is certified and authorised to recycle or destroy the material.⁹³

Box 3 Google business model example for maintenance of IT equipment⁹⁴

A circularity effort put forward by Google is their hardware management. Google specifically focuses on optimising the **process at the end of life of their hardware** resulting both in cost savings for the data centre and material savings further up the value chain, amongst material suppliers and other manufacturers of semi-finished products.

Google's data centres are tailor-made to their needs just like the servers populating them. These are purpose built and omit video cards, chipsets or peripheral connectors which off-the-shelf servers have. Using **purpose-built servers** and equipment reduces vulnerabilities of the IT-equipment and increases their energy-efficiency as the number of potential energy leaks is reduced.

Google has created its own **maintenance and repair programme** under which it uses both new and refurbished components to maintain their servers. The most commonly replaced components are hard-drives and memory disks.

Once servers reach the end of their usable life and they are decommissioned, Google dismantles them in-house and sorts the components for future use in their maintenance programme. Google also builds its own servers through their Servers Build program. Refurbished servers are considered equal to new equipment, no distinction is made in Google's inventory.

Circularity at Google's data centres requires a considerable time and financial investments as well as requiring organisational strength capability in order to maintain and moderate the different programmes through which IT equipment is maintained.

⁹² German Data Centre Association, (2020), Data Center Outlook 2021, consulted online: <https://www.germandatacenters.com/de/themen/data-center-outlook-2021-big-data-big-business/>, p. 29

⁹³ Brown, E., (2013), Electronics Disposal Efficiency (EDE): an IT Recycling Metric for Enterprises and Data Centres, The Green Grid, consulted online: <https://www.thegreengrid.org/en/resources/library-and-tools/235-WP>

⁹⁴ The Ellen McArthur Foundation, (2016), Circular Economy at work in Google data centres, consulted online: <https://www.ellenmacarthurfoundation.org/assets/downloads/data-center-case-study-14-9-16.pdf>

Google makes a relevant case for modular data centre equipment. As data centres require the latest technologies to improve their services and remain competitive, one solution is to disaggregate memory and CPU of servers. This makes it possible to design modular servers, switches, batteries and other storage equipment of which individual components can be replaced, ultimately reducing e-waste. Such modular designs can lead to savings in hardware refresh costs of 45 to 60%.⁹⁵

It is interesting to note that initiatives from the industry are emerging to decrease environmental impact and increase circularity in the ICT value chain, driven by consumer demand but also the realisation by industry stakeholders that such considerations lead to improved operations overall. The Circular Electronics Partnership (CEP) is a recent example.

Box 4 Circular Electronics Partnership

The initiative

The Circular Electronics Partnership is a group of industrial leaders in technology, consumer goods and waste management aiming to “*reimagine the value of electrical products and materials using a life cycle approach reducing waste from the design stage through to product use and recycling*”⁹⁶. One of the key instruments of the partnership is a roadmap designed by experts and electronics stakeholders with the aim to make the electronics value chain as circular as possible. The roadmap takes into account all steps in the electronics lifecycle from product design to recycling. Similarly to the present study, it ultimately aims at improving transparency in the industry on circular practices as well as contribute towards establishing international standards and definitions. It further aims at establishing a repository of best practice examples for industry stakeholders of various sizes to incorporate circular practices in their operations.

The roadmap is structured into six pathways and three time horizons up to 2023, 2027 and 2030:

⁹⁵Malyala, V., (2020), Are data centres destroying the environment?, Data Centre Review, consulted online: <https://datacentreview.com/2020/06/are-data-centres-destroying-the-environment/>

⁹⁶ Circular Electronics Partnership (2021) consulted online from [Circular Electronics Partnership \(cep2030.org\)](https://cep2030.org)

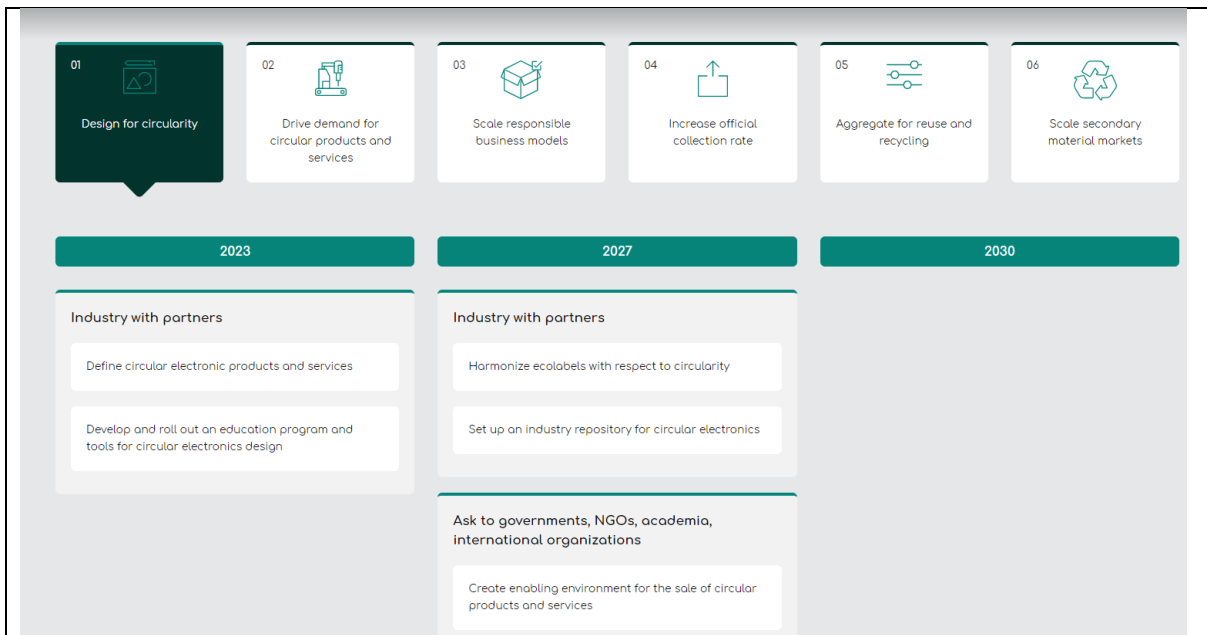

Source: CEP (2021) available from: <https://cep2030.org/our-roadmap/>

Stakeholders

The roadmap has been designed in consultation with 80 experts and 40 companies worldwide such as Microsoft, Google, DELL, Cisco and consulting firms such as Accenture and KPMG. Within its intended timeline and beyond it will involve many more private and public stakeholders in view of increasing circular practices and improve transparency in the industry.

Weblink: <https://cep2030.org/our-roadmap>

The most frequently reused components in servers are Hard Disk Drives (HDD), and memory cards. These do not become obsolete as quickly as Central Processing Units (CPU) and Power Supply Units (PSU), which typically need to be completely replaced by newer ones. The table below summarises the reuse rate and reusability index of key components for servers.

Table 13: Reuse rate and reusability index of data server components

Component	Reuse rate (%)	Reusability in mass (%)	Component	Reuse rate (%)	Reusability in mass (%)
HDD	47.7	6.3	Motherboard	2.7	6.0
Memory cards	40.1	0.5	Raid card	2.1	0.02
CPUs	5.2	0.2	Chassis	1.4	48.4
PSUs	5.0	12.3	Expansion cards	0.7	1.3

Source: JRC, Environmental Footprint and Material Efficiency Support for product policy, analysis of material efficiency requirements of enterprise servers, no. September. 2015.

A straight forward principle for circularity is **increasing components' performance and lifetime, while decreasing their size and energy requirements**. In this light, the EU has signed a declaration to develop next generation processors and 2 Nanometre chip technology. The declaration aims to allocate 145 billion euro in the coming two to three years to develop low-power processors that could, aside from data centres, be used for cars, medical equipment, telecommunications and medical devices.⁹⁷

Emerging and future market practices

The design, construction and use of data centres undergoes constant improvements aiming for energy efficiency, capacity as well as security. Innovations in the field go beyond gradual gains in efficiency and capacity. Older technologies such as **tape storage are revisited and redesigned for disruptive innovations**. Such alternatives would inspire companies to conceive of new business models for their data centres that bear the potential to significant steps towards circular practices.

Box 5: Example of IBM Tape storage innovation⁹⁸

Several companies have been considering alternatives to servers for data storage. IBM investigates innovation in tape storage towards low-cost, secure and high-volume data storage. The technology relies in essence on the same principals of electromagnetic tape found in VHS cassettes, but improves upon it. Furthermore, and perhaps most relevant, tape storage does not require energy for data storage, contrary to traditional servers. The most recent product is LTO 9 Ultrium Tape Drive technology.

Tape storage may be used in parallel with cloud services. Through artificial intelligence, decisions on where data is processed and sent to be stored, cost and energy savings can be made.

Edge services are currently not a wide-spread market practice but their popularity is slowly increasing. National data centre association interviewed identify edge-computing as a key development for data centres. Edge services are an important tool in optimising data centre infrastructure. On the one hand, edge computing allows to store the data closer to the locations where it is needed , improving response times and saving on necessary bandwidth, but on the other hand it gives large data centres the opportunity to further improve on their network. As large data centres have better circularity practices in place than small data centres, this is a relevant approach on a larger scale. Edge services are in the focus of national data centre associations across Europe as they deem it to be very relevant in the coming years for developing data centres.

⁹⁷ European Commission, (2020), Declaration, A European Initiative on Processors and semiconductor technologies, consulted online: <https://ec.europa.eu/digital-single-market/en/news/joint-declaration-processors-and-semiconductor-technologies>

⁹⁸ Urral, K., (2020), The ninth wave of tape storage innovation, IBM, consulted online: <https://www.ibm.com/blogs/systems/the-ninth-wave-of-tape-storage-innovation/>

Data centres are using servers and processors that are able to operate under higher temperatures, cutting down on cooling costs. **Additive manufacturing** holds the solution to making this technically possible. Manufacturers of semiconductors and CPU cooling components are looking into the possibility of 3D printing copper, which allows for intricate and complex designs, accommodating micro cooling channels resulting in flow mixing capabilities twice as high and twice the heat transfer of traditional components. Not only does this technology improve the technical specs of data centre hardware, but additive manufacturing also has circular qualities as components can be manufactured close to the location where they are required and the technology results in less material losses than conventional manufacturing techniques.⁹⁹

Towards policy suggestions to increase circularity of data centre hardware

Metrics for circularity of IT equipment are not individually sufficient to monitor how IT equipment is used and disposed of. It is therefore necessary to **provide a coherent set of metrics** that data centre operators can use to assess the performance and potential environmental footprint of their IT equipment over its lifetime.

When asking data centre operators in our survey what they expect from public authorities in order to implement and follow circular practices, **financial incentives** were the most sought after form of facilitation, followed by **appropriate legislation, best practice examples and guidance**, as well as **harmonised regulation and standardisation**. In view of closing the material loop of data centre hardware and on top of the set of indicators and metrics subject to this study, three key policy recommendations can be formulated:

- Optimising data centre infrastructure;
- Increase server utilisation rates;
- Provide best practice examples and guidance on treating electronic waste towards improving circularity.

There is an important potential for optimising and **further deploying data centre infrastructure** in the EU through, among others, the use of edge services and cloud computing as highlighted by interviewed national data centres associations. This effort would make data centres more circular as it reduces the number of servers and other hardware needed to satisfy an increasing demand while at the same time reducing energy demand of data centres and e-waste produced. One key aspect would be the connection to the local energy grid and the potential for industrial symbiosis in which e.g. excess heat is used to power homes. As such a **strategy on optimising data centre infrastructure in Europe**, both for now and in the future could be developed based on the current study, while also monitoring industry developments.

European-wide **recommendations for data centre operators on how to improve their server utilisation rates** would decrease the required floor space for data centres and amount of IT equipment necessary, reducing overall material use. For this, operators would benefit from clear instructions on how to maximise their utilisation rates between 25 and 50%, based

⁹⁹ Donaldson, B., (2020), The Case for Tackling the Toughest Material First, Additive Manufacturing Magazine, consulted online: <https://www.additivemanufacturing.media/articles/the-case-for-tackling-the-toughest-material-first>

on research of the most recent technology available on the market. Hence such a recommendation should be updated every two to five years to consider technological advancements. Furthermore, this would also create a level playing field at the EU level, contributing to shaping the digital single market.

Box 6: The Climate Neutral Data Center Pact: an example of a Self-Regulatory initiative

The initiative

The Climate Neutral Data Center Pact is a European agreement of national umbrella associations of data centre operators and private companies to make data centres climate neutral by 2030. It is intended to use existing directives on energy efficiency, clean energy and water and mobilise industry stakeholders to meet a specific set of targets in line with the Green Deal.

Targets

- By January 1, 2025 new data centres operating at full capacity in cool climates will meet an annual PUE target of 1.3, and 1.4 for new data centres operating at full capacity in warm climates;
- Data centre electricity demand will be matched by 75% renewable energy or hourly carbonfree energy by December 31, 2025 and 100% by December 31, 2030.
- By 2022, data centre operators will set an annual target for water usage effectiveness (WUE), or another water conservation metric, which will be met by new data centres by 2025, and by existing data centres by 2030.
- Data centres will set a high bar for circular economy practices and will assess for reuse, repair, or recycling 100% of their used server equipment.
- Data centre operators will increase the quantity of server materials repaired or reused and will create a target percentage for repair and reuse by 2025.

Weblink: <https://www.climateneutraldatacentre.net/>

Finally, the matter of electronic waste of data centres could be addressed from a policy perspective. In order to do so, small data centre operators especially need access to a database of best practice examples suited to their specific data centre type, location and overall context. Large operators typically have dedicated resources and internal financial motives to address hardware circularity autonomously. Best practice examples should highlight success stories of **how different types of data centres address hardware refurbishing and recycling and what criteria would be applied for implementing a given practice.**

Financial incentives for smaller stakeholder would further contribute to them addressing the challenge of closing the material loop of their hardware. Such financial incentives could include subsidies for data centres maintaining hardware beyond its theoretical life expectancy or for partnering with second hand markets. Policies could also be designed to support small data centre operators in partnering up with certified electronics recycling companies, putting in

place registries of such companies per European region or creating dedicated platforms where industry stakeholders can find the right partner for them.

Conclusions

Currently, the translation from what circularity means in theory to how it is applied practically is not based on a common understanding among data centre operators. Based on the desk research and interviews with stakeholders conducted, it seems that there is a lack of standardisation for data centre circularity. KPIs for circularity are not universally accepted or monitored, either because data centre operators do not know how or what to measure, because it is not technically feasible to measure, or because they do not have the economic incentives to do so. In regards to the latter, there is little economic incentive for data centre operators to implement and pursue KPIs related to circularity with pure environmental sustainability as target. Further research should go into what KPIs are relevant and feasible for operators to keep track of.

The main takeaways from this section are:

- There is a **divide in the potential to implement circular practices between operators of small and large data centres**. Operators of hyperscale data centres typically have the financial means as well as economic incentives to have strategies in place that increase their hardware's circularity, while operators of small data centres do not. The recent CEP2030¹⁰⁰ initiative can be perceived as evidence in line with this point.
- A market trend that will be key in leveraging the potential for circular practices is that of developing **components with increased performance and decreased size and energy requirements**, right from the design phase onwards. This reduces the material needs for data centre hardware and the environmental impact of mining metals, manufacturing plastic components and shipping these components through the world.
- Emerging trends such as **edge and cloud computing require new approaches to designing data centre infrastructure** with a holistic approach integrating IoT, AI, and others. In this regard monitoring future uptake will be key.
- In order for the industry to understand where potential circularity improvements can be made, it could **apply systems thinking**, tying to other relating industries as well as private consumption.

¹⁰⁰ <http://www.cep2030.org/>

Task 1.1.3: Research into methods for measuring energy and resource efficiency and recommendation for a harmonised measurement framework

Aim of this task

The aims of this task are:

- to collect and present information on current industry practices, standards, metrics, indicators (including composite indicators), methods and methodologies (jointly referred to here as 'indicators') used for the assessment of energy and resource efficiency of data centres.
- to conduct a gap analysis to identify the factors not covered by existing indicators and metrics
- to provide a proposal for a harmonised measurement framework for energy and resource efficiency based on the evaluation of currently existing methods.

The scope of the methods to be assessed covers industry practices, rules, academic literature, existing and ongoing standards in the EU and at a global level. This task focuses on energy and resource aspects. Any other aspects associated with economic performance metrics (e.g. carbon credit) or social impacts are outside the scope of this study. For the same reason, purely technical parameters, e.g. latency, error rate, will also not be considered, with the exception of certain performance or productivity metrics which have been embedded into the existing energy and resource efficiency metric.

Classification of existing metrics of DCs

A wide number of metrics already exist for measuring energy and resource aspects in data centres (DCs). Due to the high levels of energy consumption associated with IT equipment and the corresponding infrastructure in data centres, DC metrics are historically focusing on power or energy efficiency in the use phase. However, the industry has begun to realise that the focus should go beyond operational power or energy consumption with the expansion of other environmentally relevant issues, such as water, resource, primary energy, and e-waste.

Metrics are useful tools to quantify and measure as well as to evaluate the environmental performance of DCs. However, given the complexity of DCs connected with IT equipment (i.e. servers, storage, network equipment) and infrastructure equipment (i.e. HVAC systems, uninterruptible power supply (UPS), power distribution units, lighting, generators, mechanical equipment such as pumps etc.), a diverse wide range of metrics has been proposed and developed to be able to cover specific aspects of DCs. Figure 18 illustrates the relationship between metrics and characteristics of metrics as well as the aspects considered in DCs.

Figure 18. Illustration of the relationship between metrics and characteristics of metrics as well as the aspects considered in DCs

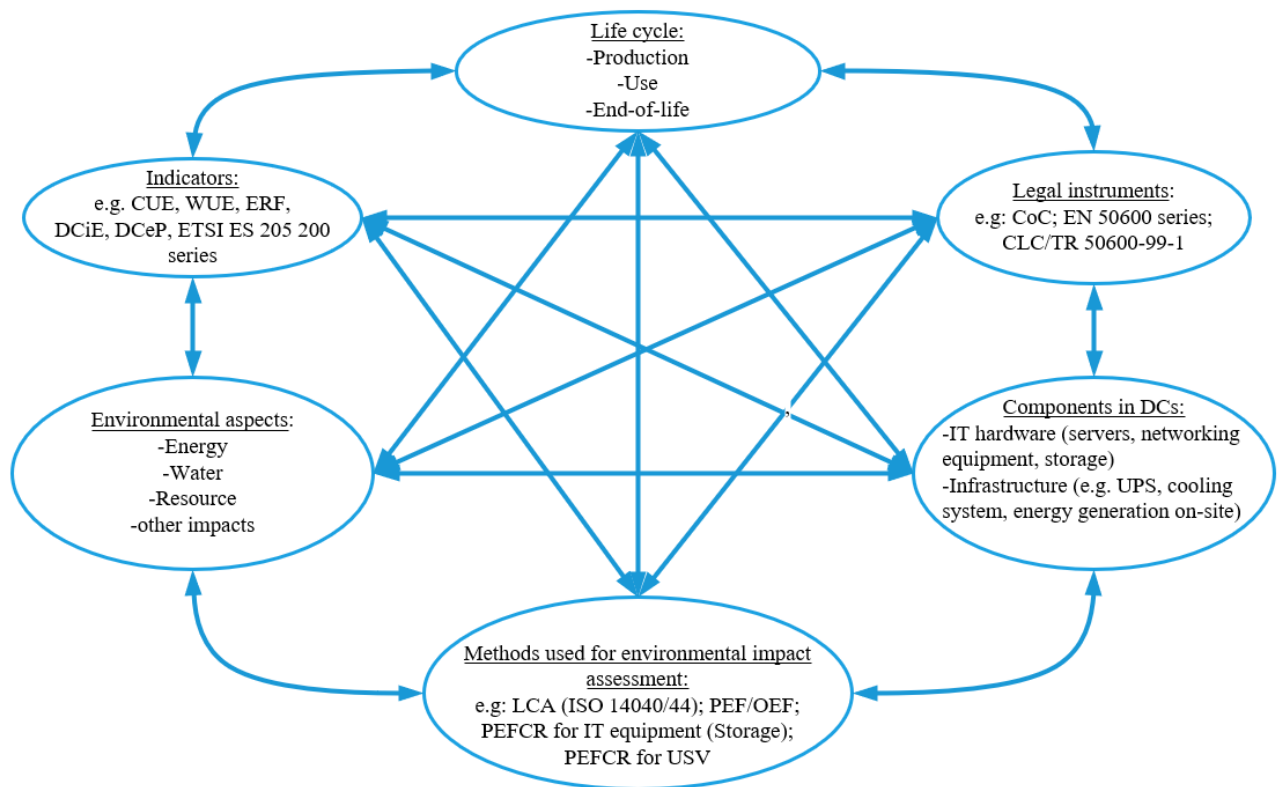

Source: Oeko-Institut

Hence, a classification is needed due to the variety of aspects addressed and the complexity of DCs component levels. A clear classification helps to understand the metrics in the given circumstances with respect to differences and individual focuses as well as interactions. This classification therefore contributes to further developing of a proposal for a harmonised measurement framework. Table 14 provides an overview of metrics classification based on the reviewed literature.

Table 14: Overview of metrics classification based on literature

Source	Focus of metrics	Classification applied
(Schödwell et al. 2018)(Schödwell et al. 2018)	ecological assessment	<ul style="list-style-type: none"> Total DCs building infrastructure Energy Climatization Miscellaneous Total IT-system Servers Storage Network
(Pehlken et al. 2019)	Energy and resource	<ul style="list-style-type: none"> IT-equipment Infrastructure Individual elements of DCs IT performance
(Smart city cluster colla-	Energy	<ul style="list-style-type: none"> IT-energy / power consumption (loads) Cooling – energy / power consumption (loads) UPS – energy / power consumption (loads)

Source	Focus of metrics	Classification applied
boration, Task 1 2014) ¹⁰¹		<ul style="list-style-type: none"> Transformer – energy / power consumption (loads) Lighting – energy / power consumption (loads) Building – energy / power consumption (loads) Energy produced locally Heat recovered Power shifting CO₂ emissions Performance
(Smart City Cluster Collaboration, Task 4 2015)	Energy (new developed metrics)	<ul style="list-style-type: none"> Flexibility mechanisms in DCs – Energy Shifting Savings family of metrics Renewables integration
(Shally et al. 2019)	Energy Efficiency	<ul style="list-style-type: none"> Computing Energy Metrics IT Equipment Energy Metrics Facility Energy Metrics DC Energy Metrics Green Energy Metrics
Chinnici et al. (2016)	Energy efficiency	3 clusters <ul style="list-style-type: none"> power/energy metrics thermal metrics productivity metrics
(Pärssinen 2016)	Energy Efficiency and Green IT Metrics	Category 1: Energy Efficiency Metric <ul style="list-style-type: none"> energy consumption of physical infrastructure energy consumption of communication elements energy consumption of computing elements network energy consumption general energy efficiency CO₂ and renewables use Category 2: data centre technology <ul style="list-style-type: none"> Servers Network Storage Cooling Air movement Uninterruptable Power Supply (UPS) Applies to all equipment
(Wilde 2018)	Energy Efficiency of High Performance Computing (HPC) DCs	4 Pillar Framework <ul style="list-style-type: none"> DC infrastructure IT system hardware IT system Software Applications
Reddy et al.	Sustainability	9 dimensions <ul style="list-style-type: none"> Energy Efficiency

²⁰In the framework of EU-funded FP7 calls, a 9-project Cluster (All4Green, CoolEmAll, GreenDataNet, RenewIT, GENiC, GEYSER, Dolfin, DC4Cities and EURECA) concerning DCs was created. The goal of the Cluster is to ensure that these 9 projects use the same metric measured in the same way while fulfilling their individual goals so that the outcomes of each project can be directly comparable and understandable by the other members of the Cluster.

Source	Focus of metrics	Classification applied
		<ul style="list-style-type: none"> • Cooling • Greenness • Performance • Thermal and Air management • Network • Storage • Security • Financial Impact
(Lykou et al. 2017)	Sustainability	2 categories: <ul style="list-style-type: none"> • IT Equipment • DC Facility 5 Sustainability Elements: <ul style="list-style-type: none"> • DCs environmental impact • Resource utilization and Economy • DCs operational efficiency • Resources Recyclability • Societal Impact
(Omar 2019)	Sustainability	9 categories <ul style="list-style-type: none"> • Energy efficiency metrics • Cooling metrics • Greenness metrics • Performance and productivity metrics • Thermal and air management metrics • Network metrics • Storage metrics • Security metrics • Financial metrics

Source: Oeko-Institut

A short summary based on the review of classification of existing literature is described below:

a) from the component perspective:

Metrics are generally classified by IT equipment and building infrastructure equipment. Depending on different levels of granularity, metrics are addressed to system and specific equipment levels. As for IT equipment, classification can specifically be further divided into servers, storage and network equipment, or the IT equipment can be considered as a whole. As for infrastructure equipment, cooling systems are the most investigated in the infrastructure equipment segment due to the fact that they consume a significant amount of energy and are also regarded as an important area for energy efficient solutions. In addition, thermal and air management describing and monitoring hot and cold air flows and temperature within DCs is treated as a separate category in infrastructure segment in certain literature.

b) from the performance perspective:

Metrics are primarily classified by environmental performance and IT performance.

- Environmental performance consists of power / energy consumption, source of energy such as renewables or share of primary energy, energy shifting after the

implementation of flexibility mechanisms, (recycling) materials or equipment needed, water consumption, waste heat and e-waste.

- IT performance could be regarded as outcome/output of a DC, which is combined with a high degree of individuality and variability of the services and applications offered by IT equipment in a DC.

Going deeper into the sub-categories, metrics indicating environmental performance could focus on the whole DC facility, or solely focus on certain concrete IT equipment (e.g. servers or storage), or on total IT equipment, or certain single infrastructure equipment (e.g. UPS). The review of existing studies show that this generic term “environmental performance” could be divided further into two groups, namely input-related and output-related. An input-related group indicates energy or materials expenditure. An output-related group was often named as “Greenness” metrics, which highlights consequences of environmental performance, e.g. CO₂-eq, waste heat reuse, efficiency of recycling etc.

- As for IT performance, “general” IT performance and “useful” IT performance should be distinguished. “General” IT performance metric describes how much work is being done without any indication whether the work is being done usefully or not. An example is utilization of IT equipment, e.g. CPU utilization, which is no determination as to whether the work being done is useful (The Green Grid 2010b).
- The “useful” IT performance metrics are often used for defining productivity proxy metrics. The working paper #13 by the Green Grid (The Green Grid 2008) described that DC productivity is “the quantity of useful information processing done relative to the amount of some resource consumed in producing the work”. Productivity metrics are generally understood as how much useful work is done by how much resource. Useful work is a general expression and defined in ITU-L 1315 as “the expected results to be delivered by a device” (ITU-T L.1315 2017). Metrics considering useful work aim to gauge the real computing, e.g. workload-related metrics (Chinnici et al. 2016). Such a metric is complex and unique for each DC depending on the applications or services running in a DC (e.g. web service, databank service, email service), so that the users evaluate the level of usefulness of the IT work-output for their business (Chinnici et al. 2016).
- However, it is important to stress that the real “useful work” has not yet been thoroughly investigated. An important finding resulting from the German KPI4DCE project (Schödwell et al. 2018) states that for every computing operation of the CPU, each stored file and every bit transferred to the outside world is interpreted as “useful”. In fact, data often is computed and stored twice and needs to be retransmitted without creating additional benefits.
- We consider broadly the useful work as workload, the number of tasks or operations executed in DCs productivity proxy metrics, since there is no standard definition of the real useful work.

c) from the perspective of sustainability:

Metrics can be classified by their contribution to a sustainable development with the sub-targets environment, economy and social impacts as well as security and privacy issues. We will not investigate this broad scope and therefore it will not be taken into account, as the focus of this task is energy and resource efficiency which are mainly environmental issues.

Overview of existing metrics of DCs

A comprehensive desk research focusing on assessing DC's energy and resource efficiency metrics has been conducted. The literature covered research studies on this topic, standardisation activities, industry initiatives, regulations etc.

Criteria in the search for existing metrics have to be limited to the following due to the high number of metrics:

- promoting an improvement in energy and resource efficiency in accordance with the aims of this task
- already existing international and European standards, e.g. ISO, EN, ITU, ETSI
- well-known and widely accepted and applied in practice / commonly adopted metrics
- organisations who have already made significant contribution to developing metrics, e.g. the Green Grid, Japan's Green IT Promotion Council, Uptime Institute, British Computer Society
- relevant DC certifications and schemes as well as labelling, in order to check whether and which metrics are adopted in their programs, e.g. German Blue Angel, Energy Star program, EU CoC for DCs
- diverse research reports and studies, especially in EU-funded projects, which have compiled metrics and/or developed new metrics.

Based on the above, the following classification has been determined to use for distinguishing the diverse metrics with the different focuses considered. The colour code as shown in Table 15 is used throughout this task and the corresponding annex.

Table 15: Colour code for classifying metrics

Classification	Sub-Category
Environmental performance metrics	Power / Energy
	Natural resource: materials, raw materials
	Water
	Waste: waste heat or e-waste
	Environmental impact: CO ₂ -eq or other environmental impact category
Combined	Environmental performance and general IT performance - combined
	Environmental performance and useful IT performance - Productivity proxy metrics

Source: Oeko-Institut

An overview of the metrics is illustrated in Table 16 with the corresponding colour code. A detailed description of each metric can be found in Annex 4, where metrics are presented

based on the above-mentioned classification in separate tables. More information on the scope, computation, and source can also be found in Annex 4.

Table 16: Overview of 71 selected metrics and 6 DC-relevant labelling or certification scheme

Total DC		Total IT equipment			
Energy / Power	Green Energy Coefficient (GEC) = Renewable energy factor (REF) Total power Usage Effectiveness (TUE) Adaptability Power Curve (APC) & Adaptability Power Curve at Renewable Energies (APC _{ren}) Data Centre Adapt (DCA) ES 205 200-2-1: KPI _{EM} Facility Efficiency (FE) Corporate Average DC Efficiency (CADE) DC Energy Productivity (DCeP) DC energy efficiency and productivity (DC-EEP) DC Performance Efficiency (DCPE) DC Performance Per Energy (DPPE) DC Workload Power Efficiency (DWPE) DC Energy Efficiency (DCEE) DC Fixed to Variable Energy Ratio (DC-FVER)	IT equipment: Server	IT equipment: Storage	IT equipment: Network	Energy / Power
		IT-Power Usage Effectiveness (ITUE)			
		Compute Power Efficiency (CPE)			
		DC Fixed to Variable Energy Ratio (DC-FVER)			
		IT Productivity per Embedded Watt (IT-PEW)			
		IT energy Productivity (ITeP)=Equipment Energy Productivity (EEP)			
		SPEC Power	SNIA Emerald™(ENERGY STAR® DC Storage /Ecodesign /German Blue Angel/ISO IEC 24091)	Telecommunications Energy Efficiency Ratio (TEER)	
		SPEC SERTTM 2 (Server Energy Effectiveness Metric (SEEM) / ETSI EN 303 470 / Energy Star Program for servers)	DC storage productivity - capacity (DCsP _{cap})	Energy Consumption Rating (ECR) ECR Variable Load (ECR-VL)	
		IT Asset Efficiency (ITAE)	DC storage productivity - Streaming (DCsP _{mb})	Energy Efficiency Ratio of Equipment (EEER)	
		IT Energy Efficiency for servers (ITEEsv)	DC storage productivity - Transactional (DCsP _{io})		
		Space, Watts and Performance (SWaP)	DC storage productivity – Transactional (DCsP _{io})		
		IT Equipment Utilisation for Servers (ITEUsv)	Storage Utilization (STOR _U)	Network Utilization (NET _U)	
		DC Compute Efficiency (DCcE)			
		Compute Utilization (CPU _U)			
		Memory Utilization (MEM _U)			
		Electronics disposal efficiency (EDE)			Wastes
		KPI4DCE: Server	KPI4DCE: Storage	KPI4DCE: Network	Environmental Impacts
		Cumulative Energy Efficiency (CEE)			
		Cumulated Performance Efficiency (CPE)			
Water		Water Usage Effectiveness (WUE): WUE _{site}			
		Water Usage Effectiveness (WUE): WUE _{source}			
Natural resource		Green Material Use (GMU)			
Wastes		Energy reuse effectiveness (ERE)			
		Energy Reuse Factor (ERF)			
		In-house Reuse Factor (IRF)			
		Sustainable Heat Exploitation (SHE)			
		Heat Usage Effectiveness (HUE)			
Environmental Impacts		Carbon Usage Effectiveness (CUE)=Technology Carbon Efficiency (TCE)			
		Primary Energy (PE) Savings			
		CO2 Savings			
		Carbon Intensity per Unit of Data (CIUD)			
Data centre labelling or certifications		Cooling system			
		Power feeding system			
		Other systems			
		Power usage effectiveness (PUE)= Site Infrastructure Energy Efficiency ratio (SI-EER) = KPI _{TE}			Energy / Power
		DC infrastructure efficiency (DCIE)= Facility Energy Efficiency (FEE)			
		Cooling Efficiency Ratio (CER)	PCFCR UPS v5.3 /		
		Energy Efficiency / Efficient Ratio (EER)	ENERGY STAR® for UPSs		
		Seasonal Energy Efficient Ratio (SEER)	version 2.0		
		Coefficient of performance (COP)	Power load factor (PLF)		
		Cooling load factor (CLF)	ITU-T L-1320: EE ratio		
		ITU-T L-1320: EE ratio			
		KPI4DCE: Infrastructure			Environmental Impacts

Source: Oeko-Institut. Hatching highlighted indicates the metrics covering other life cycle phase beyond operational stage

As Table 17 shows, metrics considering only the operational phase and energy consumption dominate in the existing metrics landscape. Metrics beyond the operational phase focus on primary energy associated with the production phase or water used in the production of energy consumed in DCs. Lifecycle based metrics were investigated by the German project KPI4DCE (Schödwell et al. 2018). They evaluated abiotic resource depletion (ADP) beyond global warming potential (GWP) and developed a tool to assist DC operators in calculating the environmental impacts associated with upstream processes. However, the emission factors provided by the KPI4DCE remains on the general level, without considering technological advantages and different configuration of IT equipment. Regarding this aspect, a research investigation is still needed.

Table 17: Number of metrics based on different perspectives

Based on life phases covered	number of metrics
metrics considering only operational phase	57
metrics beyond operational phase	7
Based on environmental aspects covered	number of metrics
metrics considering energy	50
metrics considering water	2
metrics considering materials	1
metrics considering e-waste	1
metrics considering waste heat	5
metrics considering CO ₂ -eq	4
metrics considering other environmental impacts beyond CO ₂ -eq	1

Source: Oeko-Institut

It was found that certain metrics which had been developed previously have in fact similar meanings, but come under other names. For instance, Power usage effectiveness (PUE), Site Infrastructure Energy Efficiency ratio (SI-EER) and KPITE all describe the ratio of total DC annual power/energy to total IT annual power and energy. Another comparable metric is the Data centre infrastructure efficiency (DCiE), which is the inverse of the PUE. DCiE is in turn identical to another metric, namely Facility Energy Efficiency (FEE). The metrics, Carbon Usage Effectiveness (CUE) and Technology Carbon Efficiency (TCE), basically provide the same computational formulae.

In contrast, certain metrics with the same abbreviations have different meanings. For instance, there are two metrics with the abbreviation CPE, one stands for Compute Power Efficiency quantifying the efficiency of IT equipment utilization in DCs (The Green Grid 2008). The other,

stands for Cumulated Performance Efficiency describing the total performance to the cumulated energy demand (CED) during its lifecycle (Peñaherrera and Szczepaniak 2018).

Gap analysis

The overall purpose of this task is to identify appropriate metrics that allow DC operators to measure energy and resource efficiency of DCs and also allow policy-makers to monitor energy consumption and greenhouse gas emissions in order to contribute to achieving the EU 2030 greenhouse gas emission reduction target under the Paris Agreement.

Based on this background, the next step is to examine whether such kinds of metrics already exist and to identify the potential gaps.

As already shown, there is an abundant number of metrics. It is therefore important to clarify which of these are widely accepted by the DC industry and applied in the context of policy measurement. Hence, we will go through the following four blocks below and compile the metrics used as they were created on the basis of well-established technical committees and consortia and have been compiled and validated with various stakeholders over many years.

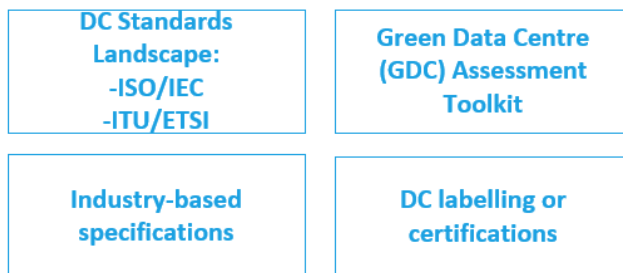

A brief description based on the four blocks above is as follows:

- The existing standards metrics of (ISO/IEC Table 18) set the definition of metrics, the measurement procedure and also the reporting requirements. These standards should be the first priority to be addressed to ensure the same applied methodology. It should be stressed that the intention of these metrics is for self-improvement, not for comparison among different data centres.

Table 18 shows a series of standards of metrics developed by ISO (the International Organization for Standardization) and IEC (the International Electrotechnical Commission). On the European standardisation level, 5 European Standards (EN) have already been completed: EN 50600-4-2 (Power Usage Effectiveness: PUE), EN 50600-4-3 (Renewable Energy Factor: REF), EN 50600-4-6 (Energy Reuse Factor: ERF), EN 50600-4-8 (Carbon Usage Effectiveness: CUE), EN 50600-4-9 (Water Usage Effectiveness: WUE). A new series of further metrics is being developed e.g. cooling efficiency ratio (CER) under EN 50600-4-7, a data centre maturity model (DCMM) under EN 50600-5-1 to meet the needs of EU policies for resource efficiency of DCs.

Table 18: ISO/IEC standards concerning energy and resource relevant metrics of DCs

ISO/IEC 21836: Server Energy Effectiveness Metric (SEEM)	ISO/IEC TR 21897* Methods and tools to assess and express energy production, storage and consumption at data centre level in reference to primary energy	ISO/IEC TR 30133* Information technology — Data centres — Guidelines for resource efficient data centres	ISO/IEC 30134-2; EN 50600-4-2;	Power Usage Effectiveness (PUE)
			ISO/IEC 30134-3; EN 50600-4-3;	Renewable Energy Factor (REF)
			ISO/IEC 30134-4	IT Equipment Energy Efficiency for Servers (ITEE _{sv})
			ISO/IEC 30134-5	IT Equipment Energy Utilisation for Servers (ITEU _{sv})
			ISO/IEC 30134-6; EN 50600-4-6;	Energy Reuse Factor (ERF)
			ISO/IEC 30134-7*; EN 50600-4-7*;	Cooling Efficiency Ratio (CER)
			ISO/IEC 30134-8; EN 50600-4-8;	Carbon Usage Effectiveness (CUE)
			ISO/IEC 30134-9; EN 50600-4-9;	Water Usage Effectiveness (WUE)
			EN 50600-5-1*	Data Center Maturity Model (DCMM)

Source: Oeko-Institut
*under development

- Another important development of DC Key Performance Indicators (KPIs) is **the Data centre maturity model (DCMM)**, which was firstly developed in 2010 by the Green Grid. CEN/CENELEC/ETSI TC215 WG 3 committee is now working on it. DCMM is integrated into the EN 50600 series and has been assigned the number EN 50600-5-1 (Booth 2020). The DCMM provides evaluation criteria so that DC operators can benchmark the current performance, determine DCs' levels of maturity and identify the improvement measurement for a better energy efficiency and sustainability (The Green Grid 2014b). Five Levels of DC Maturity are defined, namely:
 - Level 0: Minimal / No Progress
 - Level 1: part best practice
 - Level 2: Best Practice,
 - Level 3 /4: Reasonable Steps (between current best practices and the visionary five year projection)
 - Level 5: Visionary - 5 years away

DCMM assesses a wide range of DC areas, from facilities to IT. Eight categories assessed include Power, Cooling, Other Facility, Management, Compute, Storage, Network, Other IT. The most recent detailed description of criteria of each category can be found in the CATALYST Report task 8.11 (Booth 2019). Table 19 only lists the possible metrics required in the DCMM described in the Report task 8.11, since EN 50600-5-1 DCMM is still under development.

Table 19: Metrics required in the DCMM

DCMM	Metrics
Power 1.1	Power path efficiency is calculated as the ratio of IT equipment power supply unit (PSU) input power to total data centre power input.
Cooling 2.1	Power Utilisation Effectiveness (PUE)
Cooling 2.2	Rack Cooling Index RCI (HI) & RCI (LO) – If applicable
Management 4.2	Power Utilisation Effectiveness (PUE)
Management 4.3	Measuring waste heat reuse (as measured by ERF/ERE)
Management 4.4	Carbon Usage Effectiveness (CUE)
Management 4.5	Water Usage Effectiveness (WUE)
Management 4.6	Additional metrics, e.g. advanced metrics that are widely recognized in various countries and regions, such as DPPE (DC Performance Per Energy) in Japan.
Compute 5.1	The average monthly CPU utilization for the entire DC
Compute 5.2	workload management: the load on servers (CPUs)
Storage 6.1	Workload (Storage capacity)
Network 7.1	the usage of each network equipment port
Network 7.2	Workload (Data Forwarding Volume)
Other IT 8.4	Energy efficiency of the data centre's IT PSUs

Source: (Booth 2019)

- The International Telecommunication Union (ITU) and the European Telecommunications Standards Institute (ETSI) have also developed recommendations and standards to support the DC's energy efficiency targets, which cover equipment level, such as server, routers and switches, cooling and power feeding systems as well as the whole DC level (Table 20).

Table 20: ITU and ETSI energy relevant metrics concerning DCs

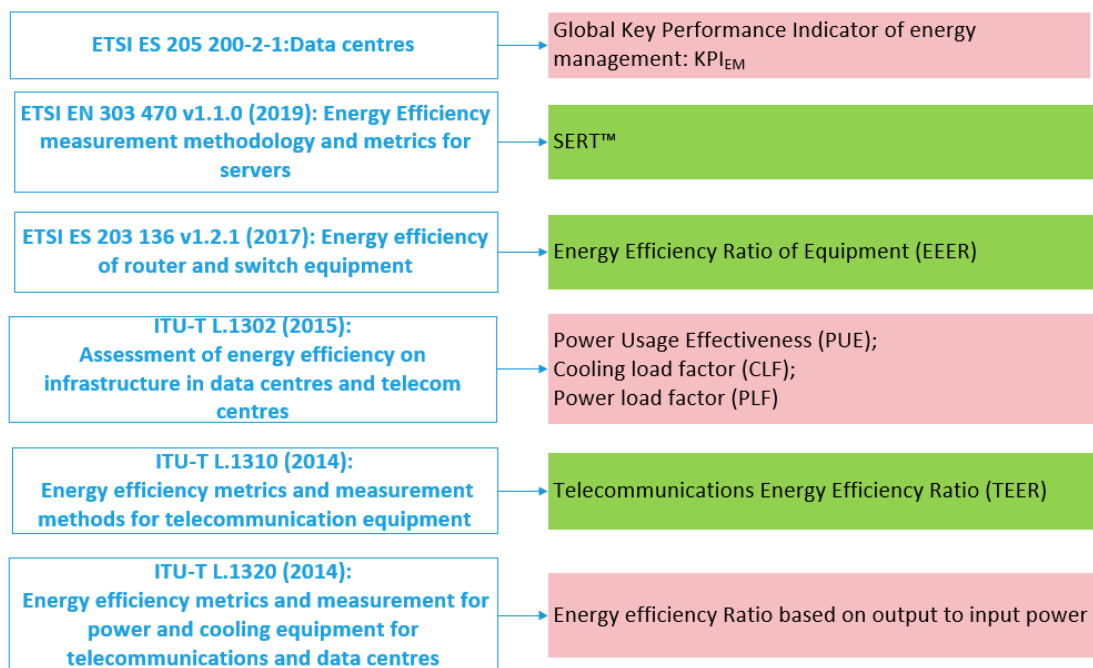

Source: Oeko-Institut

- **Industry-based specifications** are basically appropriate for benchmarking:
 - a. As for servers: Standard Performance Evaluation Corporation (**SPEC®**) **SERT** are widely adopted by:
 - I. EU Code of Conduct (CoC) for DCs,
 - II. German Blue Angel,
 - III. Ecodesign requirements for servers and data storage products (2019/424);
 - IV. Energy Star Program for servers,
 - V. Server energy effectiveness metric (SEEM) under ISO/IEC 21836,
 - VI. ETSI EN 303 470 V1.1.0 (2019) and
 - VII. also as benchmark for other metrics (e.g. IT Equipment Efficiency for servers $ITEE_{server}$).

SPEC (2019) indicated that “The metric has undergone thousands of hours of testing over a 6 year period and has been validated by SPEC, U.S. EPA, The Green Grid, Digital Europe, JEITA, METI, and others as an effective server energy efficiency metric, and is the required metric for the ISO/IEC 21836 Draft International Standard”. Page 14).
 - b. As for storage: Ecodesign requirements for servers and data storage products (2019/424) and Energy Star for DC storage is consistent with SNIA defined workload tests based on **SNIA Emerald™** Power Efficiency Measurement Specification Version 4.0.0.

- The CATALYST project¹⁰² funded by the European Union’s Horizon 2020 research and innovation programme have developed a **Green Data Centre (GDC) Assessment Toolkit** to self-assess the environmental impact of a DC facility (Georgiadou et al. 2018). The grades are defined simply as Bronze, Silver and Gold. Grade-based metrics in the examined topic is shown in Table 21. In addition to the two Water Usage Effectiveness metrics (WUE_{site} and WUE_{source}), the Electronics Disposal Efficiency (EDE) metric is also recommended, although water and e-waste management in the CATALYST context does not fall within the scope. It should be stressed that the metrics considered focus on operating expenses and do not take IT performance into account.

Table 21: Metrics considered in Green Data Centre (GDC) Assessment Toolkit by the CATALYST project

Grade-based metrics in 4 themes	Bronze	Silver	Gold
Renewable Energy	Renewable energy factor (REF) defined by EN 50600-4-3	Renewable energy factor (REF) defined by EN 50600-4-3, however only energy generated on-site is considered	Adaptability Power Curve (APCren) flexibility metric defined by the Cluster
Heat Reuse	the ratio of recovered energy over the total DC energy consumption : In-house Reuse Factor (IRF)	Energy Reuse Factor (ERF) defined by ISO/IEC 30134-6; EN 50600-4-6;	<ul style="list-style-type: none"> • Sustainable Heat Exploitation (SHE) as an indicator related to the efficiency of the waste heat recovering equipment or strategy such as a heat pump system. • Heat Usage Effectiveness (HUE): to obtain the amount of heat recovered
Energy Efficient Infrastructure	Power usage effectiveness (PUE) Category 1 defined by EN 50600-4-2:	The DC operator reports on the PUE Category 2	The DC operator reports on the PUE Category 3 .
Resources Management, such as energy, water, e-Waste	CO₂-eq resulted from DC’s facility energy consumption multiplied by Carbon Emission Factor (CEF)	The DC operator measures and reports the change in terms of <i>primary energy</i> consumed by a DC: Primary Energy (PE) Savings (s. Table 50)	Primary Energy (PE) Savings and CO₂ savings (s. Table 50)

Source: (Georgiadou et al. 2018)

¹⁰² <https://project-catalyst.eu/> The CATALYST project has considered the work resulted by the EU-funded Cluster Project (s. Table 14).

- Overview of well-known DC labelling or certifications

Table 22: Data centre labelling or certifications

Name	Promoted by	Description	Aspects considered	Metrics used	Source
Blue Angel: Energy Efficient Data Center Operation (DE-UZ 161), version 1	the German Federal Environment Agency	interdisciplinary approach covering energy, monitoring, IT load, etc.	Operation of DCs	<ul style="list-style-type: none"> • Power Usage Effectiveness (PUE) • energy efficiency ratio (EER) of the cooling system • 100% of its electricity demand from renewable energies • $ITEU_{sv} \geq 20\%$ 	(Blue Angel, The German Ecolabel 2019)
Certified Energy Efficiency Data Center Award (CEEDA)	U.K.-based award	3 levels: bronze, silver and gold	Specific assessment frameworks for Enterprises, Colocation Providers, Telcos - for both new and existing facilities.	PUE/CUE/WUE/ERE/GEC (criteria are not published. However, the frameworks are composed of best practices, standards and metrics from ASHRAE, Energy Star, ETSI, EU CoC, ITU, The Green Grid and selected ISOs.)	https://www.ceedacert.com (accessed on 4 th .01.2021)
EU Code of Conduct for DCs Best Practices (Version 11.1.0, 2020)	European Union	with the aim of reducing energy consumption through the adoption of best practices in a defined timescale.	A list of energy efficiency best practices containing sections on location, construction, power supply and distribution infrastructures and environmental control systems	a) PUE/DCiE b) SERT or SPECPower; c) IT Equipment Energy Efficiency for servers (ITEEsv) d) Data centres — Server energy effectiveness metric (SEEM) e) Coefficient Of Performance (COP) or Energy Efficiency Ratio (EER) f) Energy Reuse Factor (ERF) and Energy Reuse Effectiveness (ERE) g) Water Usage Efficiency metric (WUE)	(Acton et al. 2020)
Energy Star Program	the US Environment Protection Agency (EPA)	energy performance of a DC	At IT and infrastructure level	h) Energy Star score for facility: Actual PUE and predicted PUE i) Server: SPEC® SERT j) Storage: SNIA Emerald™ k) UPSs: Loading-adjusted energy efficiency	Energy Star
Leadership in Energy and Environmental Design (LEED), version 4.1	the US Green Building Council	General building performance, 4 Levels (certified, silver, gold, platinum) with	Integrative process (IP), Location & Transportation (LT), Sustainable Sites (SS), Water Efficiency (WE), Energy & Atmosphere (EA), Materials &	No direct reference. However, requirements e.g. cooling tower water use, water, renewable energy consider the	(LEED v4.1 2020)

Name	Promoted by	Description	Aspects considered	Metrics used	Source
		increased LEED scores	Resources (MR), Indoor Environmental Quality (EQ); Innovation (IN); Regional Priority (RP)	similar aspects of certain metrics.	
BREEAM (Building Research Establishment Environmental Assessment Method)	UK based BRE Global	General building performance based on nine categories. Buildings are rated and certified on a scale of 'Pass', 'Good', 'Very Good', 'Excellent' and 'Outstanding'	9 categories: Management, Energy use, health and well being, Pollution, Transport, land use, ecology, materials, water.	Is aligned with the EN50600 series and the EU Code of Conduct for Data Centres (Energy Efficiency).	(Booth 2019; Alger 2010)

Source: Oeko-Institut

By reviewing existing DC schemes and diverse metrics, gaps can be identified as follows:

- Different performance or applications that determine the overall configuration of the design of a DC. Therefore, DCs have different requirements for IT hardware. Each type of IT equipment has its own task e.g. the requirement on data storage depends directly on which data (emails, audio, videos, documents etc.) need to be stored in DCs. As video-on-demand services are increasing, the number of network equipment or the high speed of network equipment will also continue to grow. ISO 30134-4 also indicated that “it is difficult to calculate the summarized value of the energy effectiveness or efficiency among different types of IT equipment since the metrics for measuring their performance are different and simple addition or averaging is not an appropriate method for summarizing.” The existing metrics have mostly addressed certain specific aspects of DC systems due to the complexity of DCs. A wide range of environmental performances (energy, water, materials, waste heat, e-waste) were more or less covered. **No single metric** exists that covers all aspects of DCs to compare them regarding energy and resource efficiency.
- It has often been mentioned that the term “**useful work**” of a DC is difficult to define (Wilde 2018; ITU-T L.1315 2017; Chinnici et al. 2016). Useful work definitions vary depending on the type of IT equipment. Typically, the useful work can be defined as network transaction, computing cycles, operations per second, computational capacity, effectiveness of worklets measured by benchmarks (e.g. SPEC SERT) and the data throughput depending on the equipment usage or application being considered. Nowadays, each step of data generation, acquisition, communication and processing is assumed as “useful” work as a proxy. In fact, data often is computed, stored and retransmitted many times without creating additional benefits.
- A certain metric for **efficient data routing** is missing. Hence, high utilisation does not necessarily mean high efficiency if the servers are dealing with unnecessary data redundancy.
- IT equipment consists of typical semi-conductors, copper, precious metals and rare earth elements. Servers are replaced normally after 3-6 years. This means, regarding

the depletion of natural resources that the ICT equipment in data centres are far more relevant than the infrastructure equipment. Also, ICT equipment causes e-waste after-life. This is relevant with regard to the circular economy concept since the production of data centre ICT components (e.g. servers) is very resource intensive and contributes significantly to the embodied carbon footprint. The current metrics do not take depletion of natural resources into account. There are certain metrics for material consumption in the operational phase, but no **holistic environmental assessment perspective** exists. For this purpose, a standard tool is required that covers the holistic environmental impacts of IT equipment so that DC operators can evaluate the embodied environmental impacts.

- Metrics quantifying **refrigerants** usage and leakage amount are still missing. These are important due to their relevance to GWP and ozone depletion potential.
- Different **redundancy levels** are connected with the infrastructure requirement. Wilde (2018) described that “as a rule of thumb, the more redundant, the less energy efficient the data centre is.” Redundancy is directly connected with reliability. The question is which level of redundancy is sufficient enough without affecting reliability of individual DCs businesses and how to determine them?

Recommendation on a proposal of a harmonised methodology for measuring energy and resource efficiency

A harmonised methodology for measuring energy and resource efficiency should meet the following requirements:

- Goal-oriented: the indicators should describe a clear goal, i.e. resource efficiency and energy efficiency.
- Measurable: the indicators to be proposed should be measurable with justifiable efforts
- Usability: the indicators to be proposed should be pragmatic so that they can easily be adopted by the DCs.
- Optimisable: the indicators to be proposed enable the DCs operators to identify the improvement of the measurement in order to improve their environmental performance.
- Comparability: the indicators should be standardized to such an extent that it is possible to compare different data centres.

Recommendations for metrics with corresponding methodologies and their justification are described below.

1. **Total absolute annual IT and facility energy consumption & PUE value according to EN 50600-4-2:** Three PUE₁₋₃ categories have been defined in ISO/IEC 30134-2 depending on the measurement point and at the UPS, PDU and single IT equipment respectively. It is recommended that each DC should publish the absolute total IT and facility annual energy consumption, besides the reporting requirements defined in ISO/IEC 30134-2. PUE is still the dominant metric broadly used in the data centre industry (Canfora et al. 2020; Shehabi et al. 2016). Most DCs can calculate PUE. The main limitation to PUE is that it does not measure the energy efficiency of IT equipment

and does not take into account IT performance. Due to this limitation, PUE should be complemented by other well-established metrics of IT efficiency. With regards to the annual energy consumption, reporting on energy source with the corresponding consumption value should be given.

2. **Renewable Energy Factor (REF) according to EN 50600-4-3:** One of the key targets for 2030 under the EU climate and energy framework is at least a 32% share for renewable energy¹⁰³. This renewable energy metric could facilitate an understanding and the monitoring of the share of renewable energy used in DCs. In addition, this metric can partially address the limitation of PUE.
3. **Energy Reuse Factor (ERF) according to EN 50600-4-6:** waste heat from DCs is considerable and continuously increasing as a consequence of the growing of DC industry. The big obstacle for reusing waste heat is the low temperature, which does not meet the temperature required e.g. for the district heating system. Therefore, an additional investment cost is caused by e.g. installing heat pumps to raise the temperature. This is not affordable for small or medium DCs operators who might need more government financial support and/or professional consultants to find the application solutions with none/low additional investment. The recommendation would be that DCs with higher than a certain electric load (e.g. 1MW_{el}) should be obliged to report ERF. DCs below this load should measure and monitor the temperature of white space. 1 MW (Range between 1MW and 2MW are defined as medium size DCs) is suggested, since it is assumed that medium size DCs are capable of implementing energy reuse measurements and therefore calculating ERF metrics.
4. In terms of water consumption and water efficiency of DCs, very little has been published. **Water Usage Effectiveness on site (WUE_{site})** should be reported according to EN 50600-4-9: Water Usage Effectiveness (WUE). WUE_{site} refers to direct water usage in HVAC systems of DCs to cool the IT equipment.
5. DC operators should be obliged to report on their **disposal number and weight of obsolete IT hardware** as well as **Electronics Disposal Efficiency (EDE) metric**. Reporting the absolute value of obsolete IT hardware can support policymakers in monitoring e-waste. The ERE metric expressed in % can increase industry awareness regarding the responsible disposal of IT assets.
6. Reporting **type and amount of refrigerants** used and **leakage** amount per year. This operation expenditure should be easily obtained by the DCs since yearly technical inspection should be conducted and new refrigerants would be purchased, if refilling is required refrigerants play an important role for assessing the GWP and ozone depletion potential. Hence, understanding the realistic usage is an underlying first step for environmental impact analysis and further improvement measurements.
7. Benchmarks such as SPEC SERT for server and SNIA for storage are commonly recognised and have already been embedded in different regulations, recommendations and model schemes of DCs. **ISO/IEC 21836: Server Energy**

¹⁰³ https://ec.europa.eu/clima/policies/strategies/2030_en

Effectiveness Metric (SEEM) provides requirements on test method and reporting of the energy effectiveness of servers. This standard builds upon the SPEC v2 benchmark and additionally provides requirement for the creation of alternate server energy effectiveness metrics for servers where SERT is not applicable.

8. DC utilization, especially the actual distribution of utilization over years, is a critical indicator with respect to resource efficiency. **Utilization** metrics of servers, storage and network equipment released by The Green Grid can be used to track and communicate how ICT services are being consumed in the DC as a way to measure efficiency and effectiveness (Newmark et al. 2017). As for standardized measurement, **ISO/IEC 30134-5: IT Equipment Energy Utilisation for Servers (ITEUsv)** can be used for servers. The measurement procedure has been described in the working paper #72, by the Green Grid¹⁰⁴.

We propose to set the above-mentioned recommendations as mandatory since there are currently a large number of voluntary tools and schemes to promote the energy and resource efficiency of DCs, such as EU CoC, Green Data Centre (GDC) Assessment Toolkit.

Furthermore, carbon-footprint-relevant metrics (e.g. carbon usage effectiveness based on ISO/IEC 30134-8 or EN 50600-4-8) could be used as a **supplementary** metric beyond the metrics and inventory data mentioned above. Metrics based on the operational expenditure level provide more transparency and a straightforward statement. Certainly, DC operators can calculate their CO₂-eq by themselves. And policy makers can jointly calculate the CO₂-eq associated with energy consumption and other operational expenditures, e.g. refrigerants or water, if the expenditure data is available. However, if the carbon-footprint-relevant metrics would be determined in the policy options, the following aspects should be kept in mind:

- Different countries have a different national electricity mix so the emission factor for 1 kWh electricity generated varies. Each aggregation step hampers transparency of calculations and comparison of results as well as causing unnecessary documentation. For instance, if a carbon footprint is calculated / reported, one should document to which year the emission factor used refers to and which version of the IPCC method is used, IPCC 2007, IPCC 2013 or probably a new version of the IPCC method will be published soon.
- The primary benefit of metrics is to reduce operational expenditures, e.g. energy, resource, or water. Metrics expressed in CO₂-eq are not directly equivalent to energy consumption. France has a very low CO₂-eq emission factor for its national electricity generation due to a high share of nuclear energy. However, this does not mean that their data centres have a low energy consumption.

Hence, we strongly recommend that the emission factors used for calculating the carbon-footprint-relevant metrics should be reported together with the carbon-footprint-relevant metrics, if applied. In this sense, a standard database on the EU-level is needed, in which emission factors of electricity generated by country-specific electricity grid or by any other fossil and renewable energy sources are provided. The advantage is that emission factors in the calculation would be unified and easily updated. Also, it facilitates comparisons of

¹⁰⁴ <https://www.thegreengrid.org/en/resources/library-and-tools/436-WP#72---ICT-Capacity-and-Utilization-Metrics>

results and calculation steps. Especially for the small DCs, they might only depend on the national electricity grid, since they do not have sufficient financial means to set up their own renewable energy source(s). High emission factors of national electricity do not necessarily mean that their DCs are operated with a poor energy performance.

Recommendations for further possible policy options to policy makers

1. There is a clear trend to no longer operate data centres locally, for example in a company, but to use central data centres such as colocation or cloud service providers. With the use of cloud services, a lot of information about energy consumption and environmental impact is currently lost. Today, the operators of the data centres usually do not provide any information about how much energy they require. Nonetheless, when companies (in the role of customers) want to report on the emissions caused by their business activities (scope 3 emissions), this information is essential. Data centre operators should therefore be obliged to **report the energy consumption** of the respective service to their customers together with the cost accounting of cloud services. This obligation can also be laid down in the terms and conditions of the cloud service contract.
2. DCs are complex, which makes measurement and monitoring challenging. There is no one-size-fits-all metric so far, but it is impressive how many metrics have already been developed¹⁰⁵ in the last decade, and how many metrics might continue to be further developed. However, in some cases, certain metrics have very similar meanings but have different names, and vice versa. In other cases, metrics with the same abbreviation have different meanings. It could be very tedious for DC operators to select the right metric for what they want to measure and improve with respect to their business model of DCs. It is recommend to establish a **digital centre of DC metrics on an EU open platform** (possibly in the framework of the existing Global Harmonisation Task Force for Data Centre Metrics¹⁰⁶) to increase replicability, and avoid overlapping and confusion of metrics. The DC operators would be encouraged to put their feedback on e.g. practicality or applicability on the platform, which would be a “living” stakeholder consultation.
3. We recommend establishing a **European registration system** and statistical recording for DCs. Such a registration system serves as a database to represent various characteristics of DCs covering building year (old or new DCs), services of DCs, sizes, locations, cooling systems and types applied, number of servers/storage/network equipment, redundancy levels, technical performance (operations/IOs/throughput), temperature, humidity, IT energy consumption, total facility consumption etc.

¹⁰⁵ For instance, the German TEMPRO Project documented 68 metrics (Pehlken et al. 2019). The German KPI4DCE Project documented 94 metrics (Schödwell et al. 2018). The EU-funded Cluster Project documented 95 metrics (Smart city cluster collaboration, Task 1 2014). And all these focus on environmental performance of DCs. If other issues (i.e. economic and social issues) of sustainability are taken into account, the amount of metrics could be more.

¹⁰⁶ <https://euroalert.net/news/11898/eu-us-and-japan-harmonize-global-metrics-for-data-centre-energy-efficiency>

4. Developing a **practical guideline on how to utilize waste heat** without heavy investments for small & medium-DC operators.
5. Establishing a **standard database for emission factors** of electricity generated by country-specific electricity grid or by any other fossil and renewable energy sources on the EU-level to facilitate comparisons of results and calculation steps. This supporting tool could be in harmonisation with EU PEF activity, in which secondary database might also be provided.

2.2. Task 1.2: Indicators and standards: Electronic Communications Services and Networks

Task 1.2.1: Current practices of electronic communications network operators and service providers on reporting of their environmental performance

Aim of this task

The aim of this task is to analyse the current practices of electronic communications network and service providers regarding the reporting of their environmental performance and how it could affect end-user behaviour. The scope includes mandatory and voluntary reporting in the sector of electronic communications services and networks.

Approach to data collection

Information for this task was collected in the following ways:

- desk research of reporting methodologies and studies on current reporting practices;
- review of corporate communication via company websites and publicly available online reporting to stakeholders and consumers;
- an online survey was carried out for this project among electronic communications network operators, service providers and network equipment suppliers.

Desk research on reporting methodologies

Environmental impacts, especially greenhouse gas emissions, are the subject of various standards and guidelines for non-financial corporate reporting. Their common goal is to create transparency about the methods and frameworks used to calculate and interpret the environmental impacts that are communicated to the public. Various methodologies and guidelines for corporate reporting of environmental aspects to stakeholders and consumers exist.

Non-sector-specific GHG reporting frameworks are listed below:

- The **GHG protocol** specifies reporting of GHG emissions for companies or products. The voluntary framework is the most commonly used accounting and reporting framework. The Corporate Standard¹⁰⁷ provides GHG accounting rules for companies on how to quantify and publicly report an inventory of their GHG emissions. The

¹⁰⁷ <https://ghgprotocol.org/sites/default/files/standards/ghg-protocol-revised.pdf>

Product Life Cycle Standard¹⁰⁸ helps companies to calculate GHG emissions that are associated with a specific product. Both guides are essential to ensure that corporate reporting of GHG emissions is consistent with the following principles of GHG accounting: relevance, completeness, consistency, transparency, and accuracy. The specific requirements regarding public reporting aim at facilitating the communication with a broad variety of audiences, including institutional stakeholders (such as investors, insurance providers, authorities, etc.), but also the general public and lay persons. The guide advises its users to report on GHG emissions in such a way that the target groups can understand their influence possibilities to reduce GHG emissions. For example, the end user of the product or the consumer in general should be enabled to make informed purchasing decisions and prioritise their demand according to the most relevant GHG reduction potentials.

- **ISO 14064-1:2018**¹⁰⁹ “Greenhouse gases — Part 1: Specification with guidance at the organization level for quantification and reporting of greenhouse gas emissions and removals”

The international standard builds on the GHG protocol and specifies voluntary procedures for quantification, monitoring, accounting, and reporting of GHG emission reductions at the level of organisations. However, the standard does not facilitate the generation of comparable results as it leaves room for an individual definition of organisational boundaries in dependence from the reporting objective.

- **ISO 14064-2:2019**¹¹⁰ “Greenhouse gases – Part 2: Specification with guidance at the project level for quantification, monitoring and reporting of greenhouse gas emission reductions or removal enhancements”
 - Similar to part 1, this part sets out a voluntary method for accounting and reporting of GHG emission reductions at the level of individual projects. This could also refer to individual services of products.
- The **Carbon disclosure project (CDP)**¹¹¹ provides a global disclosure system for companies, to manage and disclose their environmental impacts.
 - The CDP is a non-profit organisation that runs a global report system that allows its user (i.e. companies) to publicly disclose GHG emissions. The CDP system represents a curated, proprietary repository of greenhouse gas emissions data that provides accountability and transparency of publicly disclosed greenhouse gas emissions. It helps companies to communicate their corporate climate impact figures to stakeholders in a harmonised framework without having to disclose business-related metadata to achieve credibility.

¹⁰⁸ https://ghgprotocol.org/sites/default/files/standards/Product-Life-Cycle-Accounting-Reporting-Standard_041613.pdf

¹⁰⁹ <https://www.iso.org/standard/66453.html>

¹¹⁰ <https://www.iso.org/standard/66454.html>

¹¹¹ <https://www.cdp.net/en>

CDP also provides a scoring methodology¹¹² for companies as an instrument to assess their progress towards stewardship in carbon footprint reduction. There are industry-specific scoring methods, but not specifically for the telecommunications sector.

- **ISO 14001:2015**¹¹³ “Environmental management” offers a certifiable verification for the implementation of environmental management systems.
 - The international standard provides a procedural framework for EMS. Applicants can obtain a certificate of compliance with the standard, which involves the principle of continual improvement, i.e. a company is obliged to state what progress it has made in terms of environmental performance and what improvement measures are planned for the future. The standard does not impose an obligation for environmental reporting beyond the publication of an environmental policy.
- **Eco-Management and Audit Scheme**¹¹⁴ (EMAS): based on the European EMAS regulation.
 - The EMAS scheme provides certifiable evidence of environmental management system implementation that is broader in scope than ISO 14001. Compared to ISO 14001, EMAS requires the fulfilment of several additional requirements in the EMS, such as a regular environmental audit and the prioritisation of all direct and indirect environmental aspects. Furthermore, EMAS requires to report on the company's environmental performance in the form of a validated environmental statement. The content and details of the environmental aspects to be reported are to fulfil the requirements of EMAS Annex IV and also depend on the company's environmental policy and the environmental aspects defined therein. They may include the carbon footprint and other relevant environmental aspects. The European Commission provides industry-specific requirements on the environmental statement in form of sectoral reference documents. For the Telecommunications and ICT services sectors, a sectoral reference document is under development. In 2020, the JRC has published a Best Practice report¹¹⁵ that describes a set of best Environmental Management Practices (BEMP) with high potential for larger uptake. The report analyses examples of environmentally relevant indicators and metrics in data centres and telecommunication networks.

¹¹²<https://guidance.cdp.net/en/tags?cid=18&ctype=theme&gettags=0&idtype=ThemeID&incchild=1µsite=0&otype=ScoringMethodology&page=1&tags=TAG-605&tprompt=IG-124%2C>

¹¹³ <https://www.iso.org/standard/60857.html>

¹¹⁴ https://ec.europa.eu/environment/emas/index_en.htm

¹¹⁵ Canfora, P., Gaudillat, P., Antonopoulos, I., Dri M. (2020): Best Environmental Management Practice in the Telecommunications and ICT Services sector. Joint Research Centre, Sevilla - Spain
<https://susproc.jrc.ec.europa.eu/activities/emas/telecom.html>

- **Global Reporting Initiative¹¹⁶** (GRI), a series of international reporting standards for disclosure.
 - The GRI is an independent international standards organisation that develops a framework for corporate sustainability reporting. The GRI guidelines are among the most well-known guidelines for voluntary corporate social responsibility (CSR) and sustainability reports worldwide. The aim is to make responsible and transparent sustainability reporting common practice. In doing so, the GRI provides reporting principles and assists in meeting content and quality requirements. The GRI criteria are: accuracy, balance, comprehensibility, comparability, reliability, and timeliness. They are assessed through stakeholder engagement, the Sustainability Code, materiality and completeness. GRI's Sustainability Reporting Guidelines are recognised by the Directive 2014/95/EU – also called the non-financial reporting directive (NFRD)¹¹⁷ - as a valid framework for corporate reporting.

Several sector-specific environmental reporting methodologies in the telecommunications and ICT industry exist:

- **ITU-T L.1470 (01/2020)¹¹⁸**: “Greenhouse gas emissions trajectories for the information and communication technology sector compatible with the UNFCCC Paris Agreement”:
 - This guideline can be used as a calculation benchmark for GHG emissions in the ICT sector and provides a basis for reporting company's GHG emissions to the public. It constitutes a normative reference for the setup of carbon emission trajectories in the context of the TK-sector specific three scope model: scope 1: direct GHG emissions; scope 2, GHG emissions related to purchased energy; scope 3: emissions over a company`s influenceable value chain. The guideline supports the public communication GHG trajectories in line with the aim of the of science-based targets (SBT) initiative¹¹⁹. Compliance with these guidelines is voluntary.
- **ITU recommendations L.1331¹²⁰ and L.1332¹²¹**: “Assessment of mobile network energy efficiency / Total network infrastructure energy efficiency metrics”:
 - The two guidelines describe a calculation metric for assessing the energy efficiency of mobile networks and overall network infrastructures. The results are to be documented in the form of an assessment report, the structure and required contents of which are described in detail in the guideline. The intended

¹¹⁶ <https://www.globalreporting.org/>

¹¹⁷ <https://eur-lex.europa.eu/legal-content/EN/TXT/?uri=CELEX%3A32014L0095>

¹¹⁸ <https://www.itu.int/ITU-T/recommendations/rec.aspx?rec=14084>

¹¹⁹ <https://sciencebasedtargets.org/>

¹²⁰ https://www.itu.int/rec/T-REC-L.1331/_page.print

¹²¹ <https://www.itu.int/rec/T-REC-L.1332-201801-I/en>

audience of the assessment reports includes telecommunication administration and a recognized operating agency rather than the general public. Compliance with these guidelines is voluntary. However, network operators should rely on these guidelines when assessing the energy efficiency of network components if these become environmental statements to be communicated to the public

- **ITU-T L.1420 (02/2012)**¹²²: “Methodology for energy consumption and greenhouse gas emissions impact assessment of information and communication technologies in organizations”
 - This ICT-sector specific guideline presents the methodology for assessing energy consumption and greenhouse gas (GHG) emissions related to the ICT infrastructure of a company. It builds on the GHG Protocol Product Life Cycle Accounting and Reporting Standard (see above). The guideline recommends a standard-conform method for the assessment of life cycle related environmental impact of ICT goods, networks and services, including PCs, servers, data centres and networks. Its scope covers direct and indirect (first and second order) effects. Further, the guideline assists in the interpretation and the reporting of these impacts in a transparent manner.
- **Joint Audit Cooperation (JAC)**¹²³

Deutsche Telekom, France Telecom and Telecom Italia founded the JAC in 2010 as a platform for auditing, evaluating and further developing the implementation of corporate social responsibility (CSR). It is open to all telecommunications operators worldwide. It serves to harmonise CSR standards throughout the ICT industry's manufacturing and supply chain at the international level. The JAC methodology includes a coordinated on-site audit and CSR implementation development programme, which also includes a set of Key Performance Indicators (KPIs). It helps suppliers measure and report their compliance with respect to the defined requirements, including calculation rules for their energy consumption and carbon footprint.

After collecting the information, a classification was made to structure the different focuses of the reporting schemes and the complexity of the different network levels (see Figure 19).

¹²² <https://www.itu.int/rec/T-REC-L.1420-201202-I>

¹²³ <https://jac-initiative.com/>

Figure 19: Illustration of the classification of the reporting schemes

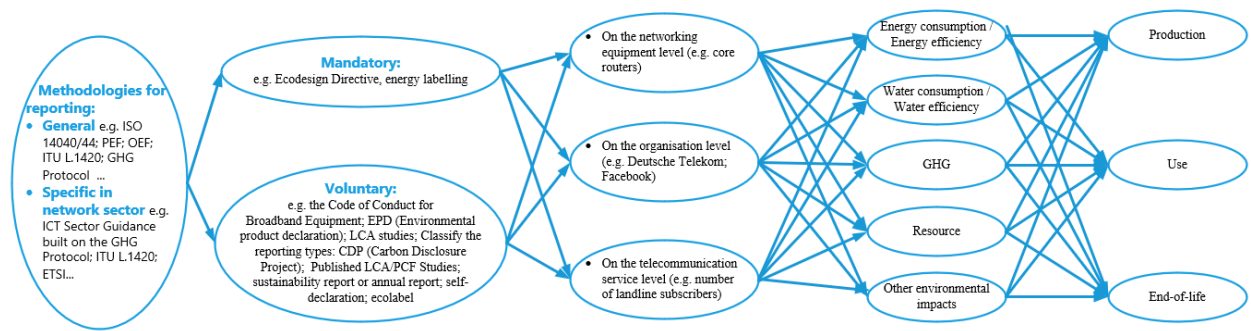

Source: Oeko-Institut

The classification of the reporting schemes has taken place according to the following criteria:

- Geographical coverage
- Scope: On the company level, on the equipment level or on the service level
- Goals: public disclosure, scoring or ranking, marketing etc.
- Target audience for reporting (e.g. end user)
- Incentives for use: regulatory, marketing (e.g. implementing an ecolabelling scheme, making an environmental claim), public disclosure, financial etc.
- Verification process (e.g. self-declaration or third-party verification)
- Reporting frequency
- Check, which environmental aspects are covered, e.g.:
 - Energy consumption and energy reduction
 - GHG emissions
 - Circular economy aspects and measurement in practice
 - others.

The following three tables (Table 23, Table 24, Table 25) show the evaluation of the reporting methodologies according to the classification and thus give an overview of the respective focus of these reports. Table 25 also evaluates the relevance of these reports for consumers. Although some of the reports can be viewed by interested consumers, they are not very well recognised by them and require a high level of technical qualification to be able to interpret them. This makes the reports unsuitable as a basis for decision-making for the majority of end-users.

Table 23: Requirements of environmental reporting schemes applicable to the telecommunications sector

Name	Mandatory / voluntary	Geographical coverage	Scope	Environmental aspects addressed	Target audience	Incentives for use
GHG protocol	V	worldwide	Company	GHG accounting	institutional stakeholders + general public	Public communication of corporate stewardship for carbon emission reduction, improvement of public reputation and credibility
ISO 14064-1	V	Worldwide	Company	GHG accounting	institutional stakeholders	Same as above
ISO 14064-2	V	Worldwide	Service	GHG accounting	institutional stakeholders	Same as above but with a closer focus on sector internal comparison
CDP	V	Worldwide	Company	GHG accounting	Investors, customers	Public disclosure of GHG emissions facilitates public reputation and credibility
ISO 14001	V	Worldwide	Company	All relevant env. aspects	institutional stakeholders + general public	Public communication of the corporate environmental policy and targets as well as progress. Demonstrates env. Stewardship towards suppliers, customers and authorities
EMAS	V	EU	Site specific	All relevant env. aspects	institutional stakeholders + general public	Same as above
GRI	V	Worldwide	Company	All relevant social & env. aspects	institutional stakeholders / general public	Same as above + additional corporate social responsibility incl. supply chain
ITU-T L.1470	V	Worldwide	Company	GHG accounting	Industry, authorities	Facilitates comparability of a company's carbon footprinting
ITU L.1331 / 32	V	worldwide	Equipment	Energy efficiency	Industry, authorities	Facilitates comparability of equipment energy efficiency
ITU-T L.1420	V	Worldwide	Company	Energy and GHG accounting	Industry, authorities	Facilitates comparability of a company's carbon footprinting
JAC	V	worldwide	Company	CSR including energy use and GHG emissions	institutional stakeholders + general public	Supply chain and customer communication

Source: Oeko-Institut

Table 24: Environmental aspects covered by reporting schemes applicable to the telecommunications sector

Name	Environmental aspects covered	Verification process	Reporting frequency
GHG protocol	GHG emissions (i.e. CO ₂ equivalents)	Verification by third party verifiers ensure correct application of the GHG Protocol Corporate Standard	Annual
ISO 14064-1	GHG emissions (i.e. CO ₂ equivalents)	Third-party validation and verification required to ensure that the reported climate change data and information is true, fair and reliable	Unspecified
ISO 14064-2	GHG emissions (i.e. CO ₂ equivalents)	Same as above	The reporting period and frequency may vary
CDP	GHG emissions (i.e. CO ₂ equivalents)	Third party verification required in accordance with a recognised verification standard	Annual
ISO 14001	All environmental aspects identified as being relevant, incl. energy consumption, GHG, land use, resource & water consumption, waste etc.	Audit by accredited independent assessor	Annual
EMAS	Same as above	Same as above + Env. statement needs approval by accredited assessor	Annual
GRI	Same as above + social aspects (e.g., Employment, non-discrimination, Occupational Health and Safety, etc.)	Voluntary notification of GRI standards-based reports, Voluntary third-party verification of compliance to GRI reporting principles is possible.	Annual or biennial
ITU-T L.1470	GHG emissions (i.e. CO ₂ equivalents)	None	Not determined
ITU L.1331 / 32	Energy consumption	None	Not determined
ITU-T L.1420	GHG emissions (i.e. CO ₂ equivalents)	None	Not determined
JAC	Focus on Energy consumption and GHG reduction, safe and fair working conditions in the supply chain, Health and Safety aspects, reduction of resource consumption (such as energy, water and raw materials) and harmful emissions, waste minimization in the supply chain.	On-site audit by a JAC accredited 3. party audit firm against JAC's CSR principles. Data assessment based on suppliers' self-declaration.	Not determined

Source: Oeko-Institut

Table 25: Evaluation of the reporting schemes

Name	Advantages	Disadvantages / Limitations	Relevance for Companies	Relevance for Consumers
GHG protocol	Enables companies to develop comprehensive and reliable inventories of their GHG emissions -> increases internal and external confidence in the reported GHG data	Claimed credibility of the scheme hinges on the proprietary verification process	Voluntary approach provides for wide acceptance and application as a reporting framework	The credibility of the system is based on the multi-stakeholder process in its creation. Interested consumers can access the guidelines;
ISO 14064-1	Same as above + additionally a validation of the reasonableness of the assumptions taken	Only Part 3 of ISO 14064 specifies the process for verification of a GHG assertion	Application of the standard improved the quality of GHG reporting	Hardly known to consumers; paywall restricts consumers' access to standards
ISO 14064-2	Same as above + focus on product / service is possible	Same as above	Apparently less often used thus far	Same as above
CDP	Uniform GHG data repository allows for comparability of the reported GHG data	Claimed credibility of the scheme hinges on the proprietary audit scheme	Little risk for companies to disclose confidential meta data to the public and competitors	Full access to data is restricted by registration & paywall
ISO 14001	Widely accepted in international business world and stakeholders,	none	State of the art in international context	Often emphasised in marketing but little known to lay persons (consumers)
EMAS	More ambitious than ISO 14001, Recognised by EU authorities and insurances	Slightly more elaborate in the implementation than ISO 14001; site specific scope	Verification ensures credibility with investors and clients	Same as above, reporting obligations provide for transparency
GRI	Clear and comprehensive guidelines are freely available. Detailed description of reporting requirements.	none	Most commonly used framework for CSR reporting, internationally well recognized by industry, authorities, media and civil society	Guidelines are freely available and provide a transparent set of reporting requirements as a reference
ITU-T L.1470	Provides detailed and sector specific calculation rules	Necessitates technical and accounting expertise	Useful as a harmonized calculation method	Hardly known to consumers
ITU L.1331 / 32	Same as above	Same as above	Same as above	Same as above
ITU-T L.1420	Same as above	Same as above	Same as above	Same as above
JAC	Self-regulation approach provides for good acceptance by TK companies worldwide	Claimed credibility of the scheme hinges on the proprietary audit scheme	Provides a harmonised approach for supply chain responsibility	Hardly known to consumers

Source: Oeko-Institut

Review of corporate environmental communication

Approach

The analysis was based on a desk research of online corporate publications. The research covered the reporting of ten major European telecommunications and network services companies which are listed in Annex 7. Two forms of corporate communication were considered: Periodic environmental or CSR reports published by these companies and non-formal communication on their websites. In reviewing the environmental or CSR reports, the latest versions of these reports were taken into account where available. These generally refer to the 2019 and 2020 reporting periods. The analysis of communication via websites was conducted in the first quarter of 2021 and represents a snapshot of the situation at this time.

The relevant reports were identified through a sequence of search queries (i.e. sustainability, environment, CSR, annual report, etc.). The reports were checked for coverage of environmental aspects, environmental goals and scope (direct and indirect aspects), use of (key performance) indicators, target audiences, and which standard or guidelines were applied for accounting and reporting. In reviewing environmental communication on corporate websites, the focus was on analysing accessibility for consumers, i.e. whether, in which form and how many clicks away from the main website the information is presented. The list of the investigated reports and websites can be found in Annex 7: Task 1.2.1 References to telecom operators' online public communication of green claims.

Findings from the review of current practices of environmental reporting by large European telecommunications network service providers

- **All ten reviewed network service providers maintain environmental management systems** according to the standard ISO14001, which implies the obligation of publishing an environmental report on an annual basis. The certification to ISO14001 implies the principle of continuous improvement of an organisations environmental performance. This means, the corporate environmental policies are subject to periodic review according to the plan-do-check-act (PDCA) cycle. The environmental reports are supposed to reflect the progress made and the update of corporate environmental policies.
- A mapping of current practices in sustainability reporting by major European telecommunications network service providers shows that priority is given to business aspects directly related to **reducing climate change impacts**. In particular, most network operators have defined targets for increasing the share of **renewable energy in electricity consumption**.
- **Seven out of ten** telecom network service providers explicitly commit to **GHG emission reduction targets** while the remainder (three) communicate energy efficiency targets that serve the same purpose of GHG-reduction.
- The purchase of **renewable energy or purchase** of guarantees of origin is the most prominent tool for achieving GHG reduction targets. Some companies also report about own renewable power plants that provide carbon neutral energy.

- However, the GHG reduction targets vary in ambition. **Two operators** claim to have already accomplished **climate-neutrality** for their own operations. **Six out of ten** companies target **net-zero CO₂ emissions from operations by 2050** at the latest while two of them pursue this target by 2022 or 2030.
- Several network service providers aim at inducing **GHG emission reductions** beyond the scope of their own operations as they intend to green their **supply chain** as well as the **upstream value chain**, i.e. helping their customers to save energy.
- Another topic in sustainability reporting is circularity. **Three out of ten companies mention circularity as a strategic objective** to be achieved in the future. Two more report on the recycling of electronic waste (WEEE). This is commonly expressed in form of measures to be implemented, such as **goals to increase the reuse, reselling or recycling** of electronic waste (WEEE) generated by networks and data centres.
- The reporting of green targets and the disclosure of data that underpin their achievement is usually subjected to a **CDP evaluation**. CDP¹²⁴ (Carbon Disclosure Project, a non-profit charity) provides a disclosure system for companies based on a guidance for data aggregation on environmental impacts. This facilitates a scoring of a company's environmental performance on a highly aggregated level and eliminated the need to the disclosure of detailed operational data.
- Green claims encompass targets on energy efficiency and carbon emission reduction on corporate level, as well as circular economy related measures such as take back and refurbishment / recycling schemes for post consumer equipment. **Hardly reported are product / technology-related performance indicators**, such as carbon footprints of network services of end user equipment. **Only one company reports a customer-related carbon footprint indicator**.

Description and summary of the main features of current reporting schemes

- **Nine out of ten network service providers have published sustainability reports**, either as a part of their corporate annual reports or in form of annual CSR / environmental reports. One network service provider communicates its sustainability commitment only via website (but without providing performance data).
- Reports concerning environmental targets focus on **GHG emissions** and **electricity consumption** or **energy efficiency indicators**. Some companies distinguish different scopes of their energy efficiency or GHG reduction targets, e.g. 1) **direct impact** (own operations), 2) **indirect impacts** caused indirectly during the supply chain (such as electricity generation in power plants), and 3) the influencing potential on the **customers' power consumption**. The definitions of the scope and the respective reduction targets varies among the companies and differ in their ambition.
- Most network service providers (**nine out of ten**) are members of the **Joint Audit Cooperation** (JAC), which is an association of telecommunications service providers

¹²⁴ Carbon Disclosure Project: <https://www.cdp.net/>

that aims at reviewing, evaluating and further developing the implementation of corporate social responsibility (CSR). It has developed a common verification, assessment and development methodology in the area of Corporate Social Responsibility (CSR) and also provides reporting guidelines describing how the audit findings shall be communicated based on objective evidence.

Description of the key findings with regard to information that affects the consumer's behaviour

- Most network service providers publish their sustainability/environmental/CSR reports as part of their annual corporate reporting and address an expert community as well as institutional stakeholders. Although the reports are publicly available (for free download) on the companies' websites, their **content is very technical and difficult to understand for non-experts**.
- Most companies provide summarised facts and figures on GHG / energy reduction targets on their websites in order to communicate to an interested non-expert audience. However, the sustainability-related information is usually presented on the business-to-business web-interfaces rather than the consumer web-interfaces, in national languages. Climate and energy related arguments are **typically not part of marketing towards consumers** whereas B2B communication presents these aspects on the websites. Reporting is usually presented in the English language as well as the language of the main market (i.e. the country where the head quarter is located).
- One of the providers has published a survey with consumers of 13 EU countries to ask about the **environmental awareness** of telecommunications customers (Vodafone 2020). The survey concludes that 65% of respondents want to take action themselves to tackle climate change. In terms of telecommunication services, they see the **reduction of new smartphone purchase frequency** as a way to achieve this. None of the survey questions asked about the efficiency of the network itself or gave the choice between different network technologies. The survey therefore shows in particular that while customers' consumption behaviour is being questioned in this one particular case, the environmental impact of the telecommunications companies themselves is not.
- A **review of the academic literature** did not reveal any relevant information on how the disclosure of environmental information might affect end-user behaviour in terms of choice of provider and in terms of use/consumption of services. Hardly any studies focusing on the state of play of environmental information disclosure at European level could be identified in the scientific literature.

Results from the online survey with electronic communications network providers and equipment manufacturers





In order to gain further insight into the practices of telecommunications companies, an online survey among electronic communication network operators, communications equipment manufacturers and European telecommunications associations was conducted in March 2021. The questionnaire for this survey can be found in Annex 4: Questions for survey to electronic communications network operators, service providers and network equipment suppliers related to Task 1.2.1 and Task 1.2.2.

A total of 25 companies responded to this survey and contributed information to this research, 16 of them answered to all the questions. Only five of the companies included in the review of corporate environmental communication (see previous section “Review of corporate environmental communication”) were among the respondents to the online questionnaire, the other respondents represent national or specialised network operators. The surveyed companies have a regional coverage of their business activities across all EU Member States and are additionally active in other European countries and partly worldwide. The results of the online survey thus provide a good overview of European telecommunications service providers. The answers of the online survey were assigned to the respective Tasks 1.2.1 (reporting) and Task 1.2.2 (assessment).

The responding companies are mainly electronic communications service providers (telephone, internet, television) and operators of electronic communication networks (14 out of 25). Some of them operate data centres (9 of 25) and some are suppliers for network equipment (8 of 25). A smaller number of the respondents (4 of 25) were associations to represent operators of electronic communications networks, semiconductor manufacturers, transport companies or software-as-a-service providers.

Table 26 shows the mainly offered services by the responding companies. The main services offered are fixed broadband internet access (100%), fixed voice communications (telephony) (91%), mobile services (voice, internet, messaging) (82%) and fixed TV (82%). Other services provided by 27% of the respondents are co-location services, satellite communications, international fiber optic cable management, streaming and media content production, internet of things, connectivity services, crowd data analytics or fixed business connectivity services.

Table 26: Which electronic communications services do you mainly offer?

	Count	% of responses	%
Fixed broadband internet access	11		100%
Fixed voice communications (telephony)	10		91%
Mobile services (voice, internet, messaging)	9		82%
Fixed TV	9		82%
Other, please specify	3		27%
None of the above	0		

N 11

Source: online survey with ECN providers and equipment manufacturers, multiple answers possible

Table 27: Most companies (70%) report on their environmental protection efforts and their environmental impact in annual reports. Almost half (45%) integrate this information into their company-wide reports as a sub-section. They also use their website (40%) and other communication channels which are presentations to business partners, research articles, press releases and internal reporting.

Table 27: How does your company report on its environmental policies and impacts?

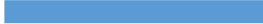
	Count	% of responses	%
With an annual report (e.g. Corporate Social Responsibility report)	14		70%
As a sub-section of an annual corporate report	9		45%
Publication of key figures on the company website	8		40%
Other, please specify	7		35%
Not at all	1		5%
Direct customer information within invoices or customer accounts	0		

N 20

Source: online survey with ECN providers and equipment manufacturers, multiple answers possible

The surveyed companies have described what objective they are pursuing through this reporting and why these reporting formats have been chosen. The following statements were made particularly often, with the most frequent statements mentioned first:

- The visibility as a **sustainable** company is supposed to be increased;
- This also includes the **transparency** of environmentally related corporate activities;
- The target group of this information is the **stakeholders** and in particular **financial investors**;
- This should also help to reassure the company's own **staff** and the **public** of the company's environmental friendliness;
- Reporting partially fulfils **legal** (e.g. UK Companies Act 2006) or **compliance requirements** (e.g. Socially responsible investing – SRI, reporting obligations);
- In summary, and thus also representative of the other statements, one company describes its motivation as follows: "We believe our reporting is essential for attracting Environmental, Social and Governance (ESG) investments and building relationships with our customers."

Table 28: The environmental reports mainly cover three areas of direct and indirect environmental effects. Direct environmental impacts (80%), environmental impacts from upstream value chains (e.g. energy, equipment, etc.) (75%), environmental impacts from downstream value chains (e.g. energy consumption or electronic waste of customers) (70%). As others (15%) emissions from transport, production and other parts of the value chain were mentioned.

Table 28: Which areas of the company's activities are included in this reporting?









	Count	% of responses	%
Direct environmental impacts	16		80%
Environmental impacts from upstream value chains (e.g. energy, equipment, etc.)	15		75%
Environmental impacts from downstream value chains (e.g. energy consumption or electronic waste at customers)	14		70%
Other, please specify	3		15%
None of the above	2		10%

N 20

Source: online survey with ECN providers and equipment manufacturers, multiple answers possible

Table 29: When asked about the specific environmental impacts that are recorded for reporting purposes, all companies (100%) indicated three impact categories: energy consumption, CO₂ equivalent and water consumption. Also very frequently mentioned are e-waste management and use of renewable energies (92%). Material consumption (73%) and energy intensity of communication networks (71%) are also widely reported. The use of renewable raw materials more seldom (27%). Other impact categories (31%) are e.g. avoided emissions through connectivity and digital services, land usage, participation at environmental initiatives.

Table 29: Which indicators do you use for environmental reporting?

	Count	% of responses	%
Energy consumption	16		100%
CO2 equivalent	16		100%
Water consumption	16		100%
E-Waste Management	15		92%
Use of renewable energies (e.g. electr., fuel)	15		92%
Material consumption	12		73%
Energy intensity of communication networks	11		71%
Use of renewable raw materials	4		27%

N 16

Source: online survey with ECN providers and equipment manufacturers, multiple answers possible









Table 30: As standards to record these environmental indicators, companies mainly name the Global Reporting Initiative (GRI) (82%) and the Greenhouse Gas Protocol (GHGP) (76%). Both environmental management standards ISO 14 001 (53%) and ISO 50 001(47%) are used by approximately half of the surveyed companies. Other used standardisation frameworks are the following that were named additionally:

- International Telecommunication Union (ITU),
- European Telecommunications Standards Institute (ETSI),
- Intergovernmental Panel on Climate Change metrics (ICCP),
- LCA,
- the Eco ICT Council Guidelines Japan,
- International Standard on Assurance Engagements (ISAE),

- Sustainability Accounting Standards Board (SASB),
- Other non-specified in-house metrics.

The main reasons indicated for using these reporting standards are that they are well known and accepted as credible assessment methods.

Table 30: What standards do you use for company-wide reporting?

	Count	% of responses	%
Global Reporting Initiative (GRI) Standards	14		82%
Greenhouse Gas (GHG) Protocol	13		76%
Environmental management according to ISO 14001	9		53%
Energy management system based on ISO 50 001	8		47%
Life Cycle Assessment (LCA) based on ISO 14040/44	4		24%
Other, please name the standard used	3		18%
International Telecommunication Union (ITU) (e.g. ITU-T L.1332)	2		12%
European Telecommunications Standards Institute (ETSI) (e.g. ETSI ES 203 475)	2		12%

N 17

Source: online survey with ECN providers and equipment manufacturers, multiple answers possible







Table 31 answers the question with which key figures the companies communicate their environmental performance to consumers. This question was only answered by 11 of the participating companies. Around half (45%) name the energy intensity of the communication network (e.g. [kWh/Gbyte]). About a third (36%) mention the energy consumption or greenhouse gas emissions per customer (e.g. CO₂-eq/subscriber). Only 18% give information about the energy consumption of the router or other network equipment in the customer's property and only one company (9%) declares the energy consumption or greenhouse gas emissions per service unit (e.g. CO₂-eq/hour video streaming).

Additional key-figures mentioned by the companies are:

- the “enablement factor”, which describes the reduction potential of digital products and services,
- the number of sustainability initiatives the company supports,
- material issues,
- and rating schemes for the sustainability of products.

One company states that they “do not provide excessive granular data directly to end-users regularly, as this information overload causes disengagement.”

Table 31: What key-figures does your company communicate to consumers (e.g. advertising, product data sheets) when reporting the environmental performance of communications services?

	Count	% of responses	%
Energy intensity of the communication network (e.g. [kWh/Gbyte])	5		45%
Energy consumption or greenhouse gas emissions per customer (e.g. CO2e/subscriber)	4		36%
Other, please specify	4		36%
Energy consumption of the router or other network equipment in the customer's property	2		18%
None of the above	2		18%
Energy consumption or greenhouse gas emissions per service unit (e.g. CO2e/hour video streaming)	1		9%
Product Environmental Footprint (PEF) (https://eplca.jrc.ec.europa.eu/EnvironmentalFootprint.html)	0		

N 11

Source: online survey with ECN providers and equipment manufacturers, multiple answers possible

Survey respondents were asked **how end-users could be encouraged to choose and use climate-friendly and resource-saving electronic communications services**. The answers vary from “almost impossible” to “better and more information” and approaches to make sustainable communication services “more trendy”. The most important statements of the companies on how end users could be motivated to environmentally friendly purchasing behaviour are:

- transparent information on energy consumption of purchased products and services;
- usage of credible eco-labels marking the most eco-friendly products;
- introduction of energy labels (e.g. showing the energy consumption per data transfer);
- introduction of a colour-coded labelling scheme (e.g. traffic light);
- possibility to compare environmental performances of different products on the market by eco-rating databases;
- awareness campaigns on the environmental impacts of ICT;
- increased focus on sustainability when advertising products to end-users;
- promoting the advantages of certain technologies (namely fibre optic cable);
- encourage the use of digital technologies instead of the physical alternatives (e.g. telepresence instead of driving to the office).

Task 1.2.1a: Options for communicating the environmental benefits of products to consumers

Aim of this task

This section gives an overview of how environmental characteristics and environmental benefits are communicated to consumers in practice. In doing so, the narrow perspective on telecommunication networks is left behind and the instruments used for other products and services are presented.

The following instruments are considered:

- Environmental labelling (Type I, II and III)
- Conformance marking
- Energy labelling
- EU Ecodesign
- Energy performance certificates for buildings
- Car label
- Electricity labelling
- Tooten Product database / online search tool for consumers
- Eco-Rating for mobile handsets
- Product Environmental Footprint (PEF)
- Product Carbon Footprint (PCF)

Environmental labelling (Type I, II and III)

The ISO 14020 to 14025 standards set out the framework for the Type I, II and III environmental labels ISO (2021). Type I and III ecolabels are labels awarded by third parties with regard to specific criteria determined over the entire life cycle. While Type I ecolabels are intended to state that products are qualitatively better with regard to the environmental properties considered, Type III ecolabels make quantitative statements based on environmental declarations (life cycle data declarations). Examples for Type I environmental labels are the European Ecolabel and national ecolabels like the German Blue Angel. Examples for Type III environmental labels are Environmental Product Declarations (EPDs). Type II labels represent claims that manufacturers make themselves for their products. Examples for Type II environmental labels are the Universal Recycling Symbol and statements like "designed to be dismantled", "reduced energy consumption".

Consumer research (e.g. BfR (2010)) states that Type I labels are among the most successful labels, especially when it comes to certain national eco-labels, like the German Blue Angel or the Nordic Swan. They have a relatively high awareness and consideration in purchasing decisions amongst consumers. In contrast, the European Ecolabel – depending on the country (e.g. in France it is relatively well known whereas in Spain not) – is less known by consumers.

Target group of Type III labels are professionals and not consumers (B2B). The information delivered e.g. by EPDs is too complex as to give orientation to consumers and to be included in consumer purchase decisions.

Conformance marking

Conformance marking is used to indicate the conformity of a product, process or system with respect to the fulfilment of specified requirements of a standard, specification or certification scheme. The best-known conformance marking in Europe is the CE¹²⁵ mark which is intended to indicate the conformity of a product with the relevant EU directives. The legal basis for the CE marking is the Directive 93/68/EEC.

¹²⁵ CE is the abbreviation for European Communities (French "Communautés Européennes")

According to consumer research (see e.g. BfR 2010) the CE mark has a relatively high level of awareness among consumers in European countries. For Germany also other conformance markings like the GS mark, the VDE mark and the GEEA Energy label are relatively well known and considered in purchase decisions of consumers.

Energy labelling

The Regulation (EU) 2017/1369, Article 1 lays down a framework that applies to energy-related products placed on the market or put into service (European Commission 2017). It provides for the labelling of those products and the provision of standard product information regarding energy efficiency, the consumption of energy and of other resources by products during use and supplementary information concerning products, thereby **enabling customers to choose more efficient products in order to reduce their energy consumption**. The energy labelling requirements for individual product groups are then determined in a process coordinated by the European Commission. Until now, 15 product groups require an energy label (European Commission 2021a). **The energy consumption and energy efficiency class must be declared** for these products on the energy label. The classification into an energy efficiency class is based on the energy consumption or the energy efficiency of a product.

According to BfR (2010) various studies have shown that the EU energy label has a high level of awareness among consumers (approx. 70-89%) and is included by a large proportion of consumers in their purchasing decisions (Germany: 64%). Consumer research done by London Economics (2014) focused on the evidence base on the most effective labelling design for possible future EU energy labels. Among other things they found some evidence that label frames which use alphabetic scales lead to more consumers choosing energy efficient products compared numeric scales - with an A to G scale leading to more consumers choosing energy efficient products compared to the A+++ to D scales. Furthermore, the choice of label design is of greater importance in influencing behaviour for products where energy efficiency is not of key importance to consumers when selecting the product.

EU Ecodesign

With the Directive 2009/125/EC, the European Commission has created a framework for certain energy-related products to be placed on the EU market only if they meet minimum requirements for environmentally sound design ("ecodesign"). Minimum criteria for environmental compatibility are defined in detail for each product group by implementing certain measures. Additionally, the directive states in article 14 **Consumer information**: "*In accordance with the applicable implementing measure, manufacturers shall ensure, in the form they deem appropriate, that consumers of products are provided with: (a) the requisite information on the role that they can play in the sustainable use of the product; and (b) when required by the implementing measures, the ecological profile of the product and the benefits of ecodesign.*" Until now EU ecodesign legislation applies to 31 product groups European Commission (2021a). National market surveillance authorities verify whether products sold in the EU follow the requirements laid out in ecodesign regulations.

Energy performance certificates for buildings

The Directive 2010/31/EU on the energy performance of buildings, article 11, paragraph 1 Energy performance certificates for buildings lays down the following: "*Member States shall*

lay down the necessary measures to establish a system of certification of the energy performance of buildings. **The energy performance certificate shall include the energy performance of a building and reference values such as minimum energy performance requirements in order to make it possible for owners or tenants of the building or building unit to compare and assess its energy performance.**”

The aim of the energy performance certificate is to provide consumers with a uniform, cost-effective and easy-to-understand instrument that provides information on the energy characteristics of a building. In Germany the German Building Energy Act [GebäudeEnergieGesetz] implements the EU directive. It allows two types of energy certificates: Type 1 is based on an expert calculation of the theoretical energy demand of a building required for heating, ventilation, air-conditioning and hot water preparation during average use. Type 2 is based on the recorded energy consumption of a building for example referring to the heating bills. Weather influences are factored out and water heating is taken into account. For both types, the final energy consumption for heating and hot water production has to be determined and expressed in kilowatt hours per year and per square meter of useful building area. For residential buildings the energy efficiency class must also be stated on energy performance certificates. The energy efficiency classes range from energy efficiency class A+ (best class) to class H (worst class). Additionally the CO₂-emissions must be stated from May 2021 onwards.

Consumer research in Germany has shown that both parameters – energy rating (energy consumption per square metre) and the colour-coded energy efficiency class (A+ to H) – are given high relevance when choosing a property (Steininger et al 2017). But the two different types of issuance (demand and consumption certificates) and their implications are often intransparent for the consumer and make comparability difficult.

Car label

The Directive 1999/94/EC relating to the availability of consumer information on fuel economy and CO₂ emissions in respect to the marketing of new passenger cars aims “*to ensure that information relating to the fuel economy and CO₂ emissions of new passenger cars offered for sale or lease in the Community is made available to consumers in order to enable consumers to make an informed choice.*” The directive is diversely implemented and operationalised throughout the EU Member States. In Germany the Passenger Car Energy Consumption Labelling Ordinance [Pkw-Energieverbrauchs-kennzeichnungsverordnung] informs consumers about the CO₂ efficiency of the vehicle with the passenger car label. In addition to the absolute consumption values, the coloured CO₂ efficiency scale provides information on how efficient the vehicle is compared to other models. The CO₂ efficiency is determined on the basis of the CO₂ emissions, taking into account the vehicle mass. The efficiency scale ranges from 'A+' (very efficient) to 'G' (least efficient). The car label also provides information on electricity consumption in order to take into account current developments in the field of electromobility.

Consumer research (Grünig et al 2010) stated that the purchase decision for a new car typically is done in two steps by consumers: in step one the type of car is chosen (e.g. small car, van) and in step two the details are considered. It seems that consumers have a low understanding of fuel economy and the real costs of cars and that consumers make little effort to include fuel consumption in purchasing decisions or assume that increased fuel

consumption is only obtained when sacrificing other qualities. Against this background, Grünig et al (2010) recommend that a car label should contain information on fuel consumption and CO₂ emissions in a way that consumers can easily include it in both steps one and two and thus include aspects related to fuel consumption in their purchasing decision.

Electricity labelling

The Directive 2009/72/EC concerning common rules for the internal market in electricity, article 3, paragraph 9, points a and b lays out the following: *“Member States shall ensure that electricity suppliers specify in or with the bills and in promotional materials made available to final customers: (a) **the contribution of each energy source to the overall fuel mix of the supplier over the preceding year in a comprehensible and, at a national level, clearly comparable manner**; (b) at least the refer-ence to existing reference sources, such as web pages, where information on the environmental impact, in terms of at **least CO₂ emissions and the radioactive waste** resulting from the electricity produced by the overall fuel mix.”* The implementation of the directive is country-specific and thus considers country-specific peculiarities. In Germany e.g. the Energy Industry Act [Energiewirtschaftsgesetz] which implements the EU Directive refers to the German Renewable Energies Act [Erneuerbare Energien Gesetz] and requires to distinguish between subsidised and non-subsidised renewable energy sources. In Germany electricity suppliers are obliged to label the individual electricity tariffs and the total electricity mix of a provider as well as the national electricity mix on the provider's website and other advertising material as well as on the electricity bill. Consumers have access to the information on CO₂ emissions and radioactive waste generated of a specific electricity tariff as a basis for decision-making before choosing a tariff and supplier. In addition, the electricity bill regularly informs them about the specific electricity composition and impact of their electricity tariff.

Consumer research on the electricity labelling in Germany showed little effect until now (UBA 2019): The lack of awareness of electricity labelling on the consumer side has so far been the big-gest obstacle to influencing decision-making behaviour. In order to have an effect, the information must additionally be the same for all electricity suppliers and presented in a way that is as easy to understand as possible.

Topten product database / online search tool for consumers

Topten is a **consumer-oriented online search tool**, which presents the best models in various product categories such as white goods, cars, computer, computer monitors, TV sets etc. Topten's key selection criteria are energy efficiency and energy consumption. The aim is to **deliver tailored product information to consumers and allow for an informed consumer choice**. Topten sees itself as a market transformation tool. Topten websites are present in 15 European countries, in 4 countries in Latin America and in China. The European websites are partially financed by different EU-projects (see e.g. Topten Act (2018)).

According to Topten Act (2018) a major barrier to broad dissemination of more energy efficient and environment-friendly equipment, products and services is that consumers do not have quick and easy access in their language to ready-made qualified, independent and up-to-date product information. The purpose of Topten is to provide consumers and energy professionals with credible, up-to-date information on the most efficient products available on their local

markets. The selection is much narrower than typical labelling systems, making it easier for consumers to choose from among the thousands of products available.

Eco-Rating for mobile handsets

A review of current eco-rating schemes of mobile handsets done by ITU (2012) identified two different approaches: in the first approach a score is assigned to each device and consumers are able to compare different devices on the bases of their scores. In the second approach all certified devices meet a minimum level of performance but no further differentiation between certified devices is provided to consumers. What unites all approaches is the overarching life cycle view and the consideration of environmental aspects. ITU (2012) recommends that any eco-rating scheme should have an audit or verification process to ensure that the final outputs are trusted by the consumer.

In May 2021, five major European telecom operators have launched a new eco rating labelling scheme (www.ecoratingdevices.com). The companies Deutsche Telekom, Orange, Telefónica, Telia Company and Vodafone want to enable their customers to compare the environmental characteristics of different mobile phones and thus select the most environmentally friendly devices. The mobile phones are evaluated on the basis of 19 different indicators grouped in five categories: Durability, Resource efficiency, Repairability, Climate efficiency and Recyclability. The best rated appliances can achieve a maximum total score of 100 points. The aim of the joint branch initiative is to ensure that mobile phones are evaluated according to uniform standards, thus creating comparability.

Product Environmental Footprint (PEF)

The Product Environmental Footprint (PEF) method measures the life cycle environmental performance of products and considers the relevant environmental impacts of all steps needed. In general 15 different environmental impact categories are considered (climate change; ozone depletion; human toxicity, cancer; human toxicity, non-cancer; Particulate matter; Ionising radiation, human health; photochemical ozone formation, human health; acidification; eutrophication, terrestrial; eutrophication, freshwater; eutrophication, marine; ecotoxicity, freshwater; land use; resource use, minerals and metals; resource use, fossils) and the most relevant are chosen (European Commission 2018b). In order to be able to compare the environmental performance of one product to another it is necessary to follow exactly the same rules. Therefore, the availability of specific PEF category rules for the respective product group is necessary that complement the general guidance. Product category rules were developed during the pilot phase for a limited number of product groups European Commission (2019b).

Consumer research was done on possible ways of communicating the PEF results of products to consumers (European Commission 2018a). The study identified a series of lessons learned on conditions for the effectiveness of communicating environmental footprint information to consumers: it is essential that information is clear, readable und transparent. Consumers understand impact categories like CO₂ emissions and energy consumption but they have difficulties to understand more complex impact categories like e.g. ecotoxicity. Consumers prefer the use of graphics, bars and colour scales to numbers and scientific terms. Moreover, consumers supported strongly the traffic light (better, average and worse represented with colours) and to the energy label format (A-E performance scale). In line with this it is

recommended to avoid information overload. For consumers, certification proves an important element to increase trustworthiness of information. Certification must be third party or come from a consumer association.

The aim of the Product Environmental Footprint (PEF) is to set the basis for better reproducibility and comparability of product related environmental assessments (European Commission 2018b). One of the main reasons why comparability is important is that “it enables consumers to take better informed purchasing decisions by comparing the performance of products in the same product category”.¹²⁶ Hence, communication and disclosure of environmental impacts to the public is the purpose of PEF. However, there is still no clear communication format after 24 product groups have been investigated during 2013-2016 in the Environmental Footprint pilot phase.

Product Environmental Footprint Category Rules (PEFCR) could be used to substantiate the claimed environmental performance/efficiency of electronic communications services. However, the following aspects should be kept in mind:

- Applying existing Product Environmental Footprint Category Rules (PEFCR) is a very time-consuming process, i.e. the investigation begins with a complex life cycle assessment study, preparation of a PEFCR draft, calculation of environmental footprint by supporting studies, communication phase, and revision and finalisation of PEFCR.
- Existence of Product Environmental Footprint Category Rules (PEFCR) is one of the preconditions to use PEF-results for the purpose of communicating the environmental benefits of products to consumers. Until now, there is no PEFCR for any electronic communications services. One other limitation of the PEF process is that there are no criteria to determine which product’s PEFCR should be developed first. If it is intended to use the PEF as a communication tool for telecommunication services, Product Environmental Footprint Category Rules (PEFCR) would first have to be developed.
- Whether and to which extend PEF-results could be suitable for communicating the environmental benefits of products to consumers would be investigated in the course of supporting studies. The results of supporting studies are the basis for the communication phase and for the testing of verification approaches.¹²⁷ Based on the experiences with the supporting studies and communication phase, the final PEFCR is produced. Although a PEFCR takes into account 15 impact categories to be used to calculate the PEF profile, it is possible to communicate e.g. 3-4 impact categories depending on which are most relevant. Different sectors or products to be investigated have different hot spots concerning the environmental performance.
- To carry out PEFs, a lot of LCA data is required, especially on the manufacturing process of electronic components. This data is usually not even available to the device manufacturers, as the telecommunication products are made up of a large number of individual components from different suppliers. Therefore, an open database with LCA

¹²⁶ https://ec.europa.eu/environment/eussd/smgp/pdf/q_a.pdf, page 4

¹²⁷ https://ec.europa.eu/environment/eussd/smgp/ef_pilots.htm

data of electronic components and equipment would be a prerequisite for PEFs to be elaborated in a uniform and efficient way. Such kind of database is not publicly available at the time of this study.

It can be summarised for the Product Environmental Footprint that this instrument can be very time-consuming and costly to apply. For ECN services, this is further complicated by the fact that they use a large number of physical products (the network) in a distributed manner and there are no suitable allocation rules for this at the moment of writing this study.

Product Carbon Footprint (PCF)

The Product Carbon Footprint (PCF) is a method for determining the climate impact of a product. It considers the whole life cycle of a product and the therewith connected greenhouse gas emissions. In the last years, various guidelines have been developed for determining the carbon footprint of products. The best known standards for calculating a carbon footprint are the British PAS 2050, the GHG Protocol and the ISO 14067 standard.

Consumer research of Carbon Trust (2020) in seven European countries and the US showed that about two thirds of respondents think that it is a good idea to feature carbon labels on products. On the other hand, 50% of consumers reply that the carbon footprint of a product is not something that they think of when selecting a product to buy. But almost two-thirds of consumers say they would feel more positive towards companies that have reduced the carbon impacts of their products.

Hottenroth et al (2013) stress that from the consumer's point of view, climate-related product information should be comparable, clear, easily accessible, instructive and available in the environment of use.

General Conclusions concerning a promising consumer communication:

- The consumer information / the label has to be simple and understandable, this is also reflected in the design (e.g. colour code, letters / numbers).
- The consumer information / label has to be easily visible and easy to find for consumers in connection with product offers (e.g. in the shop, on the website).
- The label, the way the consumer information has to be presented, has to have a high level of recognition and credibility among consumers. A high proportion of consumers should be familiar with the label.
- The classification of the consumer information / label should be relative to a reference, for example the average consumption of a household or a comparable product/service. This will allow consumers to assess whether in their specific case, the value for electricity consumption is relatively high or low or a product has a relatively low or high energy efficiency.
- An alternative is to award a Type I eco-label (e.g. European Eco-label, German Blue Angel), which is only awarded to products that meet specific minimum criteria. Consumers can thus be sure that eco-labelled products meet high standards of environmental performance without having to deal with further details.

- Ideally, the integration of the consumer information / label into the consumer decision is as easy as possible, i.e. the statement fits well with the way consumers make their decision for the specific product.

Against the background of these requirements, the energy label, an eco-label or a Topten product database are the most suitable for communicating the environmental aspects of telecommunication services. Due to its complexity, the Product Environmental Footprint (PEF), on the other hand, does not seem to be very suitable for communicating the environmental characteristics to consumers in an easily understandable way. The first three information tools mentioned were therefore considered as possible policy options for transparency measures.

Task 1.2.2: Current practices on the assessment of the environmental sustainability of new electronic communications networks

Aim of this task

The key objective of this task is to provide comprehensive information on current practices of public authorities and independent bodies for the monitoring and assessment of the environmental sustainability of new electronic communications networks. The scope of this task is limited to the new electronic communications networks as long as these networks are in a planning stage and are not yet in operation or in the process of being upgraded.

Approach

In order to obtain this overview, official documents of the EU Commission, regulatory authorities and standardisation organisations are examined to see whether requirements are set for the sustainability of new electronic communication networks. The analysis is structured into the areas encouragements and declarations, legal requirements, and voluntary instruments. In addition, telephone interviews were conducted with providers of electronic communication networks and equipment manufacturers.

Encouragements and declarations

The Digital Agenda of the European Commission from 2010 (European Commission 2010) already has the environmental impacts of ICT in mind and states as a “key action” that the ICT sector must present by the year of 2011 appropriate methods to measure energy efficiency and greenhouse gas emissions and propose appropriate legal measures.

“2.7.1. ICT for environment: ... The ICT sector should lead the way by reporting its own environmental performance by adopting a common measurement framework as a basis for setting targets to reduce energy use and greenhouse gas emissions of all processes involved in production, distribution, use and disposal of ICT products and delivery of ICT services.”

“The Commission will:

- Key Action 12: Assess by 2011 whether the ICT sector has complied with the timeline to adopt common measurement methodologies for the sector's own energy performance and greenhouse gas emissions and propose legal measures if appropriate;”

As a reaction to the Digital Agenda, various initiatives have been launched by the EU Commission to implement the measuring of the environmental impacts of ICT in practice. One of these is the study on the “ICT footprint” which was carried out together with 27 ICT companies (varying from telecommunication operators, software & services providers to equipment and components manufacturers) to test different methodologies in pilot projects (European Commission 2013). The different methods whose applicability has been verified in practice by the project are listed in Table 32.

Table 32: Methods for measuring the ICT footprint of organisations, products and services

Methodology	Description
ITU-T L.1410	Methodology for environmental impacts assessment of ICT goods, networks and services
ITU-T L.1420	Methodology for environmental impacts assessment of ICT in organisations
ETSI TS 103 199	Life Cycle Assessment (LCA) of ICT equipment, networks and services: General methodology and common requirements
GHG Protocol Product Standard – ICT-sector Guidance	Product Life Cycle Accounting and Reporting Standard - ICTsector Guidance
GHG Protocol Corporate (Value Chain) Standard	Corporate Accounting and Reporting Standard - including the Corporate Value Chain (Scope 3) Standard (not ICT specific)
IEC/TR 62725	Analysis of quantification methodologies for greenhouse gas emissions for electrical and electronic products and systems

Source: European Commission 2013

The pilot study on ICT footprints (European Commission 2013) concluded that existing methods are well suited to measure the energy consumption and CO₂ emissions of ICT. However, there are still several methodological challenges to ensure that the results are consistently recorded and are comparable between different applications.

Another study commissioned by the EU Commission “Study on the practical application of the new framework methodology for measuring the environmental impact of ICT” (Prakash et al. 2014) concluded that the existing accounting methods are sufficient, but that there is a significant implementation deficit. The study described the status quo as follows:

- Lack of environmental policy measures on data centres and telecommunication networks,
- Lack of publicly available data on data centres and telecommunication networks,
- No need to develop more detailed and restrictive methodologies for the ICT sector.

The Commission's Recommendation (EU) 2020/1307 on a common Union toolbox for reducing the cost of deploying very high capacity networks (European Commission 2020a) resumed the original intention of the Digital Agenda and recommends promoting the roll-out of new networks in a way that reduces their greenhouse gas footprint:

“The environmental footprint of the electronic communications sector is increasing, and it is essential to consider all possible means of counteracting this trend. Incentives to deploy networks with, for example, a reduced carbon footprint can contribute to the sustainability of the sector and to climate change mitigation and adaptation. Member States are called upon, in close cooperation with the Commission, to identify and promote such incentives, which might include fast-track permit granting procedures or reduced permit and access fees for networks which meet certain environmental criteria.”

In 2020, the European Commission has relaunched its digitisation strategy (European Commission 2020b). Under the title "Shaping Europe's digital future", digital transformation should be put at the service of people (“technology that works for the people”), further strengthen the European economy (“a fair and competitive digital economy”) and enhance European climate protection goals as well as data protection (“an open, democratic and sustainable society”). In the strategy, the European Commission states:

“Data centres and telecommunications will need to become more energy efficient, reuse waste energy, and use more renewable energy sources. They can and should become climate neutral by 2030.”

Several key actions are presented that should be implemented to achieve these goals. They include launching initiatives to ensure that by climate-neutral, highly energy-efficient and sustainable data centres are established by 2030 at the latest. In addition, transparency measures are to be introduced for telecommunication operators that provide information about their environmental footprint.

A stakeholder survey conducted by the *Body of European Regulators for Electronic Communications* (BEREC) among telecommunications service providers showed that there is a great willingness to improve the sustainability of electronic networks and reduce greenhouse gas emissions (BEREC 2020).

Legal requirements

In order to build new networks, telecommunication network operators must comply with a number of legal requirements. This concerns in particular the construction of new buildings (e.g. switching exchanges or antenna masts), the installation of antennas and radio equipment, as well as work to install cables through the terrain or along roads or general electrical installations. These legal requirements will not be examined in detail here. Rather, the aim is to show whether requirements are placed here on the energy efficiency or resource conservation of the network infrastructure.

[European Electronic Communications Code 2018/1972/EU \(EECC\)](#)

The European Electronic Communications Code (EECC)¹²⁸ establishes a harmonised framework for the regulation of electronic communications networks, electronic communications services, associated facilities and associated services, and certain aspects of terminal equipment. It lays down tasks of national regulatory authorities and, where applicable, of other competent authorities, and establishes a set of procedures to ensure the harmonised application of the regulatory framework throughout the Union.

[Radio Equipment Directive 2014/53/EU \(RED Directive\)](#)

The Radio Equipment Directive (RED)¹²⁹ specifies the regulatory requirements for radio equipment. It sets out basic requirements for health and safety, electromagnetic compatibility and the use of the radio spectrum. Several other regulations build on the RED, regulating additional technical and data protection-related aspects. The RED does not include requirements for energy efficiency or the use of materials in radio equipment.

[Electromagnetic Compatibility Directive 2014/30/EU \(EMC Directive\)](#)

The Electromagnetic Compatibility Directive (EMC Directive)¹³⁰ ensures that electrical and electronic equipment does not cause electromagnetic interference and is not itself disturbed by such interference. For this purpose, requirements are set for maximum electromagnetic emissions from equipment so that radio and telecommunications systems can be operated without disturbance. In order for equipment to be sold and put into operation in Europe, it must meet these requirements. The directive has only an indirect effect on the energy consumption of radio equipment, since the risk of electromagnetic interference increases with increasing transmission power.

[Strategic Environmental Assessment Directive 2001/42/EC \(SEA Directive\)](#)

The Strategic Environmental Assessment Directive (SEA Directive)¹³¹ must be applied to a wide range of public plans and programmes (e.g. on land use, transport, energy, waste, agriculture, etc.). The Protocol on Strategic Environmental Assessment ensures that potential environmental impacts are identified and avoided at an early stage in the implementation of a construction project.

Member states must carry out a screening process to determine whether plans are likely to have significant environmental effects. If there are significant effects, a Strategic Environmental Assessment is required. The screening procedure is based on criteria set out in the Directive. If, for example, the expansion of digital infrastructures is promoted by the member states, the requirements of the SEA Directive must also be taken into account.

¹²⁸ <https://eur-lex.europa.eu/eli/dir/2018/1972/2018-12-17>

¹²⁹ https://ec.europa.eu/growth/sectors/electrical-engineering/red-directive_en

¹³⁰ https://ec.europa.eu/growth/sectors/electrical-engineering/emc-directive_en

¹³¹ <https://ec.europa.eu/environment/eia/sea-legalcontext.htm>

[Environmental Impact Assessment Directive 2011/92/EU \(EIA Directive\)](#)

The Environmental Impact Assessment Directive (EIA Directive)¹³² applies to a wide range of public and private projects as set out in the Annexes to the Directive. For example, long-distance railway lines, motorways, aircraft runways, waste disposal plants, sewage treatment plants above a certain size are each considered to have a significant environmental impact. These installations must carry out an environmental impact assessment at the planning stage. Whether telecommunication networks also fall under this directive could not be examined within the framework of this project, as no legal expertise was involved here. In principle, however, it is conceivable that such projects could also be subject to an environmental impact assessment.

[Broadband Cost Reduction Directive 2014/61/EU](#)

The Directive on measures to reduce the cost of deploying high-speed electronic communications networks (Broadband Cost Reduction Directive)¹³³ (European Commission 2014) aims to help speed up the roll-out of electronic communications networks and reduce their costs. This is to be achieved, among other things, through the sharing and reuse of existing infrastructures. The measures of the directive focus on four main areas: access to existing physical infrastructure, efficient coordination of civil works, simplified permits, requirements for buildings to facilitate access for high-speed networks.

The directive does not contain any requirements for the energy efficiency of networks or for resource protection.

Voluntary Instruments

[EU Code of Conduct on Energy Consumption of Broadband Equipment \(CoC\)](#)

The EU Code of Conduct on Energy Consumption of Broadband Equipment (CoC)¹³⁴ (Bertoldi and Lejeune 2020) is one of the tools described in Task 1.2.3 Standards and measurement methodologies for the monitoring of environmental footprint of electronic communications networks and services. The EU Code of Conduct is a voluntary system of minimum requirements for broadband equipment developed by the EU's own research institute Joint Research Centre (JRC) in cooperation with network component manufacturers and network operators. The agreement sets minimum requirements for network components, both on the customer premises equipment (CPE) side and on the network side.

The EU Code of Conduct is widely used by network operators and is a recognised benchmarking data base. As the technical development in this area is very fast, the Code may have the disadvantage that it does not include certain technologies (e.g. currently not 5G) or sets requirements for them that are already technically outdated. However, as it is a voluntary

¹³² <https://ec.europa.eu/environment/eia/eia-legalcontext.htm>

¹³³ <https://ec.europa.eu/digital-single-market/en/cost-reduction-measures>

¹³⁴ <https://e3p.jrc.ec.europa.eu/publications/eu-code-conduct-energy-consumption-broadband-equipment-version-71>

instrument negotiated through stakeholder dialogue, it can be adapted and updated comparatively quickly.

[ITU Telecom Network Planning for evolving Network Architectures Reference Manual](#)

In 2007 and 2008, the International Telecommunication Union (ITU) undertook the effort to develop a good practice guide for telecommunications network planning called “ITU Telecom Network Planning for evolving Network Architectures Reference Manual”¹³⁵ (ITU 2008). The reference manual is addressed to telecommunications network operators, policy makers and regulators. And is intended to facilitate the strategic planning of network expansion. Even though the handbook is now more than 13 years old, it still presents basic methods that can be considered in network planning. As technical development has progressed in the meantime and new requirements, such as energy and resource consumption have become more prominent, the handbook would need to be thoroughly updated once again to help increase efficiency in networks.

[Procurement guidelines of electronic communication providers](#)

In the discussions with the telecommunications companies about their purchasing practices, they mentioned on several occasions their own company guidelines that they use in procurement. The company Liberty Global even makes these guidelines publicly available, which is why they can be mentioned here as an example (Liberty Global 2019: Responsible Procurement and Supply Chain Principles)¹³⁶.

In principle, such in-house minimum standards are suitable for imposing stricter environmental or social requirements on purchased products and thus assuming producer responsibility for the supply chain. This is particularly necessary if there are no ambitious legal minimum requirements. For the companies offering the products themselves, the problem arises that different customers may demand different minimum standards or accept different verification systems. Against this background, it would be desirable to define uniform standards that can then be used equally by all companies.

Results from telephone interviews with electronic communication network providers and equipment manufactureres

In order to get an overview of what is being done in practice for planning new networks and for energy-efficient operation, questionnaire-based interviews were conducted with a total of 9 network operators, manufacturers and associations (see

¹³⁵ https://www.itu.int/ITU-D/tech/NGN/Manual/Version5/NPM_V05_January2008_PART1.pdf

¹³⁶ <https://www.libertyglobal.com/wp-content/uploads/2019/06/Responsible-Procurement-and-Supply-Chain-Principles-2019.pdf>

Glossary and list of acronyms

Acronyms	Full meaning
3G, 4G, 5G	Respectively third, fourth and fifth generation cellular communications network technology
3DP	3D Printing
ADSL	Asymmetric Digital Subscriber Line
AI	Artificial Intelligence
ASHRAE	American Society of Heating, Refrigerating and Air Conditioning Engineers
BEREC	Body of European Regulators for Electronic Communications
BRP	Building Renovation Passport
CDN	Content Delivery Network
CDP	Carbon disclosure project
CEEDA	Certified Energy Efficiency Data Centre Award (UK)
CEN	European Committee for Standardization
CENELEC	European Committee for Electrotechnical Standardization
CO ₂ -eq	Carbon dioxide (equivalents)
CoC	Code of Conduct
CoLo	Colocation data centre
CPU	Central processing unit
CSR report	Corporate social responsibility or sustainability report
CSRD	Corporate Sustainable Reporting Directive
DCs	Data Centres
DG CONNECT	The Directorate-General for Communications Networks, Content and Technology of the European Commission
DLT	Distributed Ledger Technology

DNSH	Do not significantly harm criteria
EC	European Commission
ECN	Electronic Communications Network
ECS	Electronic Communications Service
EEA	European Economic Area
EED	Energy Efficiency Directive
EEE	electrical and electronic equipment
EMAS	Eco-Management and Audit Scheme
EMF	electromagnetic field
EPBD	Energy Performance of Buildings Directive
EPC	Energy Performance Certificates
ESO	European Standards Organisation
ETSI	European Telecommunications Standards Institute (one of the ESOs besides CEN and CENELEC)
EU	European Union
FAN	Fixed Asset Network
FWC	Framework contract
FTTH	Fiber To The Home network
GDC	Green Data Centre
GHG	Greenhouse gas
GRI	Global Reporting initiative
Gt	Giga tonnes
GWP	Global warming potential
HDD	Hard Disk Drive
ICCP	Intergovernmental Panel on Climate Change
ICT	Information and communication technologies,

IoT	Internet of Things
IPCEI	Important Projects of Common European Interest
ISAE	International Standard on Assurance Engagements
ISO 14040/44,	International standard for Life Cycle Assessments
JAC	Joint Audit Cooperation
JRC	Joint Research Centre of the European Commission
KPI	Key performance indicators
LCA	Life Cycle Assessments
LTE	Long-Term Evolution technology
LTRS	Long-term Renovation Strategies
MEPS	Mandatory minimum Energy performance Standards
MS	Member States
MSP	Managed Service Providers
NFRD	Non-financial Reporting Directive
NFV	Network Functions Virtualisation technologies
NIEE	Total Network Infrastructure Energy Efficiency
NZEB	Nearly Zero-energy Buildings
OCP	Open Compute Project (OCP)
PCF	Product Carbon Footprint
PDU	(data centre) Power Distribution Unit
PEF	Product Environmental Footprint
PEFCR	Product Environmental Footprint category rules
POP	Point of Presence
PSU	Power supply unit
PUE	Power usage effectiveness of data centres
RAN	Radio Access Network

ROI	Return On Investment
SASB	Sustainability Accounting Standards Board
SCM	Standard Cost Model
SDN	Software Defined Networking
SFDR	Sustainable Finance Disclosure Regulation
SFT	Sustainable Finance Taxonomy
SRI	Smart Readiness Indicator
TCE	Total Cost to the Environment
TCO	Total Cost of Ownership
TEG	Technical Expert Group on Sustainable Finance
ToR	Terms of references
TRL	Technology Readiness Level
TSSP	Thematic Smart Specialisation Platform
TWh	Tera-Watthours
UMTS	Universal Mobile Telecommunications System
UPS	Uninterruptible Power Supply
VDSL	Very high-speed Digital Subscriber Line
WAN	Wide Area Network
WEEE	Waste Electrical and Electronic Equipment

References

- Acton, M.; Bertoldi, P.; Booth, J. (2020): 2020 Best Practice Guidelines for the EU Code of Conduct on Data Centre Energy Efficiency. Version 11.1.0 (Final Version). European Commission, Ispra, 2020, JRC119571. Available online at https://e3p.jrc.ec.europa.eu/sites/default/files/documents/publications/jrc119571_jrc119571_2020_best_practice_guidelines_v11.1.0a_br_ma_21_jan.pdf, checked on 1/14/2021.
- Alfieri, F., Dodd, N., Gama-Caldas, M., Wolf, O., Maya-Drysdale, L., Huang, B., Viegand, J., Flucjer, S., Tozer, R., Whitehead, B., Brocklehurst, F., (2019) Development of European Green Public Procurement Criteria for Data Centres – Preliminary report, JRC Technical Report, EUR 29945 EN, Publications Office of the European Union, Luxembourg, 2019, ISBN 978-92-76-10382-0, doi:10.2760/327087, JRC118550.
- Alger, Douglas (2010): Grow a Grenner Data Center. Chapter 2: Measuring Green Data Centers. Available online at https://cdn.ttgtmedia.com/searchSystemsChannel/downloads/Growing_a_Green_Data_Center_9781587058134_CH02.pdf, checked on 12/29/2020.
- Al-Shehri, Salman M.; Loskot, Pavel; Numanoglu, Tolga; Mert, Mehmet (n.d.): Common Metrics for Analyzing, Developing and Managing Telecommunication Networks. Available online at <https://arxiv.org/ftp/arxiv/papers/1707/1707.03290.pdf>, checked on 1/14/2021.
- Andor, Mark; Gerster, Andreas; Sommer, Stephan (2017): Consumer Inattention, Heuristic Thinking and the Role of Energy Labels. Essen (Ruhr economic papers, 671). Available online at http://www.rwi-essen.de/media/content/pages/publikationen/ruhr-economic-papers/rep_17_671.pdf.
- Andrae A.S.G. (2020) Hypotheses for primary energy use, electricity use and CO2 emissions of global computing and its shares of the total between 2020 and 2030. WSEAS TRANSACTIONS on POWER SYSTEMS DOI: 10.37394/232016.2020.15.6 <https://www.wseas.org/multimedia/journals/power/2020/a125116-083.pdf>
- BEREC (2020): BEREC Report on the outcome of the public consultation on the draft BEREC Work Programme 2021. BEREC - Body of European Regulators for Electronic Communications. Available online at https://berec.europa.eu/eng/document_register/subject_matter/berec/download/0/9719-berec-report-on-the-outcome-of-the-publi_0.pdf, checked on 3/10/2021.
- Bertoldi, P. ; Avgerinou, M.; Castellazzi, L. (2017) Trends in data centre energy consumption under the European Code of Conduct for Data Centre Energy Efficiency, EUR 28874 EN, Publications Office of the European Union, Luxembourg, 2017, ISBN 978-92-79-76445-5, doi:10.2760/358256, JRC108354
- Bertoldi, P; Lejeune, A (2020): Code of Conduct on Energy Consumption of Broadband Equipment. Version 7.1. European Commission, Ispra 2020, JRC119761. Available online at <https://e3p.jrc.ec.europa.eu/publications/eu-code-conduct-energy-consumption-broadband-equipment-version-71>, checked on 1/23/2021.
- Berwald, Anton; Faninger, Thibault; Bayramoglu, Sara; Tinetti, Benoît; Mudgal, Shailendra; Stobbe, Lutz; Nissen, Nils (2015): Ecodesign Preparatory Study on Enterprise Servers and Data Equipment. ENTR Lot 9. Edited by European Union, checked on 1/14/2021.
- BfR (2010): Grenzen und Möglichkeiten der Verbraucherinformation durch Produktkennzeichnung. With assistance of W. Konrad, D. Scheer. Edited by A. Epp, S.

Kurzenhäuser, R. Hertel, G.-F. Bö. Bundesinstitut für Risikobewertung (BfR). Institut für ökologische Wirtschaftsforschung – IÖW.

Blackburn, Mark (2012): Data Center Storage Efficiency Metrics. The Green Grid Forum 2012. Available online at <https://www.thegreengrid.org/en/resources/library-and-tools/145-2012-Forum-%E2%80%93-Data-Center-Storage-Efficiency-Metric>, checked on 1/14/2021.

Blue Angel, The German Ecolabel (Ed.) (2019): Energy Efficient Data Center Operation. Blue Angel, The German Ecolabel, Basic Award Criteria Edition January 2019, Version 1. Available online at <https://produktinfo.blauer-engel.de/uploads/criteriafile/en/DE-UZ%20161-201901-en%20Criteria-2019-03-21.pdf>, checked on 5/31/2021.

Booth, John (2019): D8.6 Green DC Energy Efficiency Roadmap V1. CATALYST.D8.6.GIT.WP8.v1.0 (H2020-EE-2016-2017), checked on 1/5/2021.

Booth, John (2020): D8.11 Green DC Energy Efficiency Roadmap V2. CATALYST.D8.11.GIT.WP8.v1.0 (H2020-EE-2016-2017). Available online at https://project-catalyst.eu/wp-content/uploads/2020/09/CATALYST.D8.11.GIT_.WP8_.V1.0package.pdf, checked on 1/20/2021.

Brill, Kenneth G. (2007): Data center energy efficiency and productivity. The Uptime Institute. Available online at <http://large.stanford.edu/courses/2017/ph240/you2/docs/brill.pdf>, checked on 12/30/2020.

Brotherton, Heather M. (2013): Datacenter Efficiency Measures, checked on 12/30/2020.

Canfora P., Gaudillat P., Antonopoulos I., Dri M., (2020) Best Environmental Management Practice in the Telecommunications and ICT Services sector, EUR 30365 EN, Publications Office of the European Union, Luxembourg, 2020, ISBN 978-92-76-21574-5, doi:10.2760/354984, JRC121781

Carbon Trust (2020): Product carbon footprint labelling. Consumer research 2020. Available online at <https://prod-drupal-files.storage.googleapis.com/documents/resource/restricted/Product-carbon-footprint-labelling-report-v3.pdf>.

Chinnici, M.; Capozzoli, A.; Serale, G. (2016): Measuring energy efficiency in data centers. In Ciprian Dobre, Fatos Xhafa, M. Chinnici, A. Capozzoli, G. Serale (Eds.): Pervasive computing. Next generation platforms for intelligent data collection. Amsterdam, Boston: Elsevier/AP Academic Press is an imprint of Elsevier (Intelligent data-centric systems).

CISCO (2020): 2019 Corporate Social Responsibility Report. Available online at https://www.cisco.com/c/dam/m/en_us/about/csr/csr-report/2019/_pdf/csr-report-2019.pdf.

Consumer Focus (2012): Under the influence? Consumer attitudes to buying appliances and energy labels, checked on 12/21/2015.

Define (2017): Broadband Fibre Qualitative Research. Final Report. Edited by Define research & insight. Available online at <https://www.asa.org.uk/uploads/assets/uploaded/d791272c-805a-495d-8e25650af1740ab7.pdf>.

Dodd, N., Alfieri, F., Maya-Drysdale, L., Viegand, J., Flucker, S., Tozer, R., Whitehead, B., Wu, A., Brocklehurst F., (2020) Development of the EU Green Public Procurement (GPP) Criteria for Data Centres Server Rooms and Cloud Services, Final Technical Report,, EUR 30251 EN, Publications Office of the European Union, Luxembourg, 2020, ISBN 978-92-76-19447-7, doi:10.2760/964841, JRC118558

- EDNA (2019): Intelligent Efficiency For Data Centres & Wide Area Networks. Report Prepared for IEA-4E EDNA. Available online at <https://www.iea-4e.org/document/428/intelligent-efficiency-for-data-centres-and-wide-area-networks>, checked on 1/29/2021.
- Egmond, C.; Bruel, R. (2007): Nothing is as practical as a good theory,. Analysis of theories and a tool for developing interventions to influence energy-related behaviour. Available online at http://www.cres.gr/behave/pdf/paper_final_draft_CE1309.pdf.
- Egmond, C.; Jonkers, R.; Kok G. (2005): A strategy to encourage housing associations to invest in energy conservation. In Energy Policy (33), pp. 2374–2384. Available online at <https://www.sciencedirect.com/science/article/abs/pii/S0301421504001600>, checked on 7/30/2021.
- EN ISO 14024:2018: Environmental labels and declarations - Type I environmental labelling - Principles and procedures (ISO 14024:2018).
- Energy Star (2018): ENERGY STAR Score for Data Centers in the United States. Technical Reference. Available online at https://www.energystar.gov/sites/default/files/tools/Data_Center_August_2018_EN_508.pdf, checked on 12/30/2020.
- Ericsson (2020): Ericsson Mobility Report. Available online at <https://www.ericsson.com/4adc87/assets/local/mobility-report/documents/2020/november-2020-ericsson-mobility-report.pdf>.
- ETSI EN 303 470 V1.1.0 (2019): ETSI EN 303 470 - V1.1.0 - Environmental Engineering (EE); Energy Efficiency measurement methodology and metrics for servers, checked on 1/14/2021.
- ETSI ES 203 136 v1.2.1 (2017): ES 203 136 - V1.2.1 - Environmental Engineering (EE); Measurement methods for energy efficiency of router and switch equipment, checked on 1/13/2021.
- ETSI ES 203 199 V1.2.1: ES 203 199 - V1.2.1 - Environmental Engineering (EE); Methodology for environmental Life Cycle Assessment (LCA) of Information and Communication Technology (ICT) goods, networks and services, checked on 2/9/2021.
- ETSI ES 205 200-2-1 (2014): ETSI ES 205 200-2-1 - V1.2.1 - Access, Terminals, Transmission and Multiplexing (ATTM); Energy management; Global KPIs; Operational infrastructures; Part 2: Specific requirements; Sub-part 1: Data centres, checked on 1/17/2021.
- European Commission (2010): A Digital Agenda for Europe. Communication from the Commission to the European Parliament, the Council, the European Economic and Social Committee and the Committee of the Regions. COM(2010)245 final. Available online at <https://eur-lex.europa.eu/LexUriServ/LexUriServ.do?uri=COM:2010:0245:FIN:EN:PDF>, checked on 3/10/2021.
- European Commission (2013): ICT footprint. Pilot testing on methodologies for energy consumption and carbon footprint of the ICT-sector. SMART-Nr 2011/0078. Ecofys; Quantis; BIO Intelligence Service. Available online at https://ec.europa.eu/newsroom/dae/document.cfm?doc_id=1710, checked on 3/10/2021.
- European Commission (2014): Directive 2014/61/EU of the European Parliament and of the Council of 15 May 2014 on measures to reduce the cost of deploying high-speed electronic communications networks. Available online at [147](https://eur-</p>
</div>
<div data-bbox=)

lex.europa.eu/legal-content/EN/TXT/PDF/?uri=CELEX:32014L0061&from=EN, checked on 3/10/2021.

European Commission (2017): Regulation (EU) 2017/1369 of the European Parliament and of the Council of 4 July 2017 setting a framework for energy labelling and repealing Directive 2010/30/EU. Available online at <https://eur-lex.europa.eu/legal-content/en/TXT/?uri=CELEX%3A32017R1369>, checked on 8/16/2021.

European Commission (2018a): Assessment of different communication vehicles for providing Environmental Footprint information. Final Report. Francisco Lupiáñez-Villanueva, Pietro Tornese, Giuseppe A. Veltri and George Gaskell. Presented in consortium by LSA & Partner. European Commission. Directorate General Environment. Directorate A – Green Economy. ENV.A.1 – Eco-Innovation & Circular Economy. Available online at https://ec.europa.eu/environment/eusssd/smgp/pdf/2018_pilotphase_commreport.pdf.

European Commission (2018b): Product Environmental Footprint Category Rules Guidance. Version 6.3 – May 2018. Available online at https://ec.europa.eu/environment/eusssd/smgp/pdf/PEFCR_guidance_v6.3.pdf, checked on 8/6/2021.

European Commission (2018c): Report from the Commission to the European Parliament and the Council. on the implementation of Directive 2014/61/EU of the European Parliament and of the Council of 15 May 2014 on measures to reduce the cost of deploying high-speed electronic communications networks. Available online at <https://eur-lex.europa.eu/legal-content/EN/TXT/?uri=COM%3A2018%3A492%3AFIN>, checked on 3/10/2021.

European Commission (2019a): Special Eurobarometer 490. Climate Change. Conducted by Kantar Public at the request of Directorate-General for Climate Action. Survey coordinated by the Directorate-General for Communication (DG COMM 'Media monitoring and Eurobarometer' Unit). Available online at <https://europa.eu/eurobarometer/api/deliverable/download/file?deliverableId=70456>.

European Commission (2019b): Single Market for Green Products - The Product Environmental Footprint Pilots - Environment - European Commission. Available online at https://ec.europa.eu/environment/eusssd/smgp/ef_pilots.htm, updated on 12/31/2019, checked on 8/6/2021.

European Commission (2020a): Commission Recommendation (EU) 2020/1307 of 18 September 2020 on a common Union toolbox for reducing the cost of deploying very high capacity networks and ensuring timely and investment-friendly access to 5G radio spectrum, to foster connectivity in support of economic recovery from the COVID-19 crisis in the Union. Available online at <https://eur-lex.europa.eu/legal-content/EN/TXT/?uri=CELEX:32020H1307>, checked on 3/10/2021.

European Commission (2020b): Shaping Europe's digital future. Luxembourg: Publications Office of the European Union. Available online at https://ec.europa.eu/info/sites/info/files/communication-shaping-europes-digital-future-feb2020_en_4.pdf, checked on 4/8/2021.

European Commission (2021a): Rules and requirements for energy labelling and ecodesign. Available online at https://ec.europa.eu/info/energy-climate-change-environment/standards-tools-and-labels/products-labelling-rules-and-requirements/energy-label-and-ecodesign/rules-and-requirements_en, updated on 3/8/2021, checked on 8/6/2021.

European Commission (2021b): Special Eurobarometer 510. E-Communications in the Single Market. Available online at <https://europa.eu/eurobarometer/surveys/detail/2232>, checked on 8/9/2021.

- forsa (2009): Verständlichkeit und Einflussfaktoren für verschiedene Optionen der grafischen Neugestaltung der EU-einheitlichen Energieverbrauchskennzeichnung [Understandability and influencing factors for different options for the graphical redesign of the common EU Energy Label]. dena Deutsche Energie Agentur, checked on 12/21/2015.
- Georgiadou, Vasiliki; Chenadec, Julie; Irazoqui, Cristobal (2018): D2.2 Green Data Centre Assessment Toolkit. Version 1.0. CATALYST.D2.2.GIT.WP2.v1.0 (H2020-EE-2016-2017), checked on 12/22/2020.
- GHG Protocol ICT Sector Guidance (2017): ICT Sector Guidance built on the GHG Protocol Product Life Cycle Accounting and Reporting Standard. Available online at <https://www.ghgprotocol.org/sites/default/files/ghgp/GHGP-ICTSG%20-%20ALL%20Chapters.pdf>, checked on 2/9/2021.
- Green IT Promotion Council (2012): New Data Center Energy Efficiency Evaluation Index - (DPPE) Datacenter Performance per Energy Measurement Guidelines (Ver 2.05). Available online at https://home.jeita.or.jp/greenit-pc/topics/release/pdf/dppe_e_DPPE_Measurement_Guidelines.pdf, checked on 1/20/2021.
- Green, L. W.; Kreuter, M. W. (1999): Health promotion planning. An Educational and Ecological Approach. 3rd edition. Mountain View, California.
- Gröger, Jens; Liu, Ran (2021): Green Cloud Computing. Lebenszyklusbasierte Datenerhebung zu Umweltwirkungen des Cloud Computing. With assistance of Lutz Stobbe, Jan Druschke, Nikolai Richter. Edited by Umweltbundesamt. Dessau-Roßlau. Available online at https://www.umweltbundesamt.de/sites/default/files/medien/5750/publikationen/2021-06-17_texte_94-2021_green-cloud-computing.pdf, checked on 8/10/2021.
- Grünig et al (2010): Study on Consumer Information on Fuel Economy and CO2 Emissions of New Passenger Cars. Implementation of the Directive 1999/94/EC. Available online at [https://www.europarl.europa.eu/RegData/etudes/etudes/join/2010/433455/IPOL-ENVI_ET\(2010\)433455_EN.pdf](https://www.europarl.europa.eu/RegData/etudes/etudes/join/2010/433455/IPOL-ENVI_ET(2010)433455_EN.pdf), checked on 8/6/2021.
- Hottenroth et al (2013): Carbon Footprints für Produkte. Handbuch für die betriebliche Praxis kleiner und mittlerer Unternehmen. With assistance of Heidi Hottenroth, Bettina Joa, Mario Schmidt. Hochschule Pforzheim, Institut für Industrial Ecology. Available online at https://www.hs-pforzheim.de/fileadmin/user_upload/uploads_redakteur/Forschung/INEC/Dokumente/Hottenroth_et_al_Carbon_Footprints_fuer_Produkte_web.pdf.
- Hurtado, R.; Paralera, M. (2016): Preferences of university students on the choice of internet service provider. Available online at <http://www.revistalatinacs.org/071/paper/1102/22en.html>.
- Ipsos MORI; London Economics; AEA (2012): Research on EU product label options. Final report, checked on 12/21/2015.
- ISO (2021): Environmental labels. Available online at <https://www.iso.org/publication/PUB100323.html>, updated on 8/6/2021, checked on 8/6/2021.
- ISO 14040 (2006): Environmental management - Life cycle assessment - Principles and framework.
- ITU (2008): Telecom Network Planning for evolving Network Architectures Reference Manual. Draft version 5.1; January 2008. Document NPM/5.1. International Telecommunication Union (ITU). Geneva. Available online at <https://www.itu.int/ITU->

- D/tech/NGN/Manual/Version5/NPM_V05_January2008_PART1.pdf, checked on 3/11/2021.
- ITU (2012): Review of mobile handset eco-rating schemes. Edited by International Telecommunication Union (ITU). Available online at https://www.itu.int/dms_pub/itu-t/oth/4B/01/T4B010000030001PDFE.pdf.
- ITU-T L.1315 (2017): ITU-T Rec. L.1315 (05/2017) Standardization terms and trends in energy efficiency. Edited by International Telecommunication Union (ITU, checked on 1/13/2021.
- ITU-T L.1410 (2014): ITU-T Rec. L.1410 (12/2014) Methodology for environmental life cycle assessments of information and communication technology goods, networks and services. Available online at <https://www.itu.int/rec/T-REC-L.1410-201412-I>, checked on 2/9/2021.
- ITU-T L-1302 (2015): ITU-T Rec. L.1302 (11/2015) Assessment of energy efficiency on infrastructure in data centres and telecom centres. Edited by International Telecommunication Union (ITU, checked on 1/14/2021.
- ITU-T L1310 (2020): ITU-T Rec. L.1310 (09/2020) Energy efficiency metrics and measurement methods for telecommunication equipment. Recommendation ITU-T L.1310. Edited by International Telecommunication Union (ITU. Available online at <https://www.itu.int/rec/T-REC-L.1310-202009-I/en>, checked on 1/23/2021.
- ITU-T L-1320 (2014): ITU-T Rec. L.1320 (03/2014) Energy efficiency metrics and measurement for power and cooling equipment for telecommunications and data centres. Edited by International Telecommunication Union (ITU, checked on 1/13/2021.
- ITU-T L-1470 (2020): ITU-T Rec. L.1470 (01/2020) Greenhouse gas emissions trajectories for the information and communication technology sector compatible with the UNFCCC Paris Agreement. Available online at <https://www.itu.int/rec/T-REC-L.1470-202001-I/en>, checked on 2/3/2021.
- Köhler, Andreas R.; Gröger, Jens; Liu, Ran (2018): Energie- und Ressourcenverbräuche der Digitalisierung. Expertise für das WBGU-Hauptgutachten „Unsere gemeinsame digitale Zukunft“. Available online at https://www.researchgate.net/publication/335490910_Energie-_und_Ressourcenverbrauche_der_Digitalisierung_Expertise_fur_das_WBGU-Hauptgutachten_Unsere_gemeinsame_digitale_Zukunft.
- Kollaras, Antonios; Tirabasso, Fabio (2014): Deliverable D2.1 Business scenarios and use case analysis. FP7-ICT-609140 – DOLFIN. Data Centres Optimization for Energy-Efficient and EnvironmentalLy Friendly INternet, checked on 1/17/2021.
- LEED v4.1 (2020): LEED v4.1 Building Design and Construction. Edited by U.S. Green Building Council. Available online at <https://www.usgbc.org/leed/v41>, checked on 1/5/2021.
- Levy, Moises; Raviv, Daniel (2017): A Novel Framework for Data Center Metrics using a Multidimensional Approach. 15th LACCEI International Multi-Conference for Engineering, Education, and Technology: “Global Partnerships for. Available online at http://www.laccei.org/LACCEI2017-BocaRaton/full_papers/FP387.pdf, checked on 12/28/2020.
- Liberty Global (2019): Responsible Procurement and Supply Chain Principles. Available online at <https://www.libertyglobal.com/wp-content/uploads/2019/06/Responsible-Procurement-and-Supply-Chain-Principles-2019.pdf>, checked on 3/11/2021.
- Liu, Ran; Gailhofer, Peter; Gensch, Carl-Otto; Köhler, Andreas; Wolff, Franziska (2019): Impacts of the digital transformation on the environment and sustainability. Issue

- Paper under Task 3 from the “Service contract on future EU environment policy”. Available online at https://ec.europa.eu/environment/enveco/resource_efficiency/pdf/studies/issue_paper_digital_transformation_20191220_final.pdf.
- London Economics (2014): Study on the impact of the energy label - and potential changes to it - on consumer understanding and on purchase decisions. ENER/C3/2013-428. Final Report. Ordered by the European Commission. Available online at <https://ec.europa.eu/energy/sites/ener/files/documents/Impact%20of%20energy%20labels%20on%20consumer%20behaviour.pdf>.
- London Economics; IPSOS (2014): Study on the impact of the energy label – and potential changes to it – on consumer understanding and on purchase decisions ENER/C3/2013-428 Final Report, checked on 12/21/2015.
- Lundberg, Sofia and Marklund, Per-Olov and Brännlund, Runar, Assessment of Green Public Procurement as a Policy Tool: Cost-Efficiency and Competition Considerations (May 8, 2009). Available at SSRN: <https://ssrn.com/abstract=1831089> or <http://dx.doi.org/10.2139/ssrn.1831089>
- Lykou, G.; Mentzelioti, D.; Gritzalis, D. (2017): A new methodology towards effectively assessing data center sustainability. DOI: 10.1016/j.cose.2017.12.008.
- Molenbroek, Edith; Smith, Matthew; Groenenberg, Heleen; Waide, Paul; Attali, Sophie; Fischer, Corinna et al. (2013): Evaluation of the Energy Labelling Directive and specific aspects of the Ecodesign Directive. ENER/C3/2012-523. Background report I: Literature review.
- Montevecchi, F., Stickler, T., Hintemann, R., Hinterholzer, S. (2020). Energy-efficient Cloud Computing Technologies and Policies for an Eco-friendly Cloud Market. Final Study Report on behalf of the European Commission, DG CONNECT . Vienna
- Mudgal, Shailendra; Tinetti, Benoît; Faninger, Thibault; Proske, Marina; Schischke, Karsten; Prakash, Siddharth; Liu, Ran (2013): Toward an overall measurement methodology of the carbon and energy footprints of the ICT sector. FINAL REPORT (SMART 2011/0073). Available online at <https://op.europa.eu/en/publication-detail/-/publication/9a79fd07-27af-4ad5-b39f-0fe11a49b9e5>, checked on 2/9/2021.
- Newcombe, Liam; Limbuwala, Zahl; Latham, Paul; Smith, Victor (2012): Data centre Fixed to Variable Energy Ratio metric DC-FVER. An alternative to useful work metrics which focuses operators on eliminating fixed energy consumption. Edited by BCS Data Centre Specialist Group. Available online at https://www.bcs.org/media/2917/dc_fver_metric_v10.pdf, checked on 1/12/2021.
- Newmark, Rona; Isaak, Phil; Vincent, Jay (2017): Applying ICT Capacity and Utilization Metrics to Improve Data Center Efficiency. Available online at <https://www.thegreengrid.org/en/resources/library-and-tools/443-Appling-ICT-Capacity-and-Utilization-Metrics-to-Improve-Data-Center-Efficiency>, checked on 1/20/2021.
- Omar, Emad (2019): Data Center Simulator for Sustainable Data Centers. Available online at <https://elib.uni-stuttgart.de/bitstream/11682/10604/1/Masterarbeit%20-%20Data%20Center%20Simulator%20for%20Sustainable%20Data%20Centers.pdf>, checked on 1/6/2021.
- Pärssinen, Matti (2016): Analysis and Forming of Energy Efficiency and GreenIT Metrics Framework for Sonera Helsinki Data Center HDC. Available online at <https://core.ac.uk/download/pdf/80719192.pdf>, checked on 1/6/2021.
- Patel, Chandrakant D.; Sharma, Ratnesh K.; Bash, Cullen E.; Beitelmal, Monem; (Keine Angabe) (2006): Energy Fow in the Information Technology Stack: Coefficient of

- Performance of the Ensemble and its Impact on the Total Cost of Ownership. Edited by L. P. Hewlett-Packard Development Company, checked on 12/30/2020.
- Patterson, Michael K; Poole, Stephen W; Hsu, Chung-Hsing; Maxwell, Don; Tschudi, William; Coles, Henry et al. (2013): TUE, a new energy-efficiency metric applied at ORNL's Jaguar. In International Supercomputing Conference ISC 2013, pp. 372–382. Available online at https://dcpro.lbl.gov/sites/all/files/isc13_tuepaper.pdf, checked on 12/30/2020.
- PCFCR - UPS (2020): Product Environmental Footprint Category Rules – Uninterruptible Power Supply (UPS). Version: 5.3. Available online at https://ec.europa.eu/environment/eusds/mgmp/pdf/PEFCR_UPS_Feb%202020_2.pdf, checked on 1/5/2021.
- Pehlken, Alexandra; Hintemann, Ralph; Penaherrera, Fernando; Gizli, Volkan; Hurrelmann, Karsten; Hinterholzer, Simon et al. (2019): Abschlussbericht Verbundprojekt TEMPRO. Total Energy Management for Professional Data Center Ganzheitliches Energiemanagement in professionellen Rechenzentren. Edited by Bundesministerium für Wirtschaft und Technologie, 6. Energieforschungsprogramm. Available online at https://tempro-energy.de/images/pdfs/Tempro_Endbericht_final_2020_05_14.pdf, checked on 1/6/2021.
- Peñaherrera, Fernando; Szczepaniak, Katharina (2018): Development and Application of Metrics for Evaluation of Cumulative Energy Efficiency for IT Devices in Data Centers. In Alexandra Pehlken, Matthias Kalverkamp, Rikka Wittstock (Eds.): Cascade Use in Technologies 2018. Berlin, Heidelberg: Springer Berlin Heidelberg, pp. 142–153.
- Pino, Albena (2017): The Environmental Impacts of The Environmental Impacts of Core Networks for Mobile Telecommunications: A Study Based on the Life Cycle Assessment (LCA) of Core Network Equipment. Available online at <https://pdfs.semanticscholar.org/5be6/bcba0a0b0d1d01f804bb44157b3377ff8a95.pdf>.
- Prakash, S.; Baron, Y.; Liu, R. (2014): Study on the practical application of the new framework methodology for measuring the environmental impact of ICT - cost/benefit analysis (SMART 2012/0064). With assistance of M. Proske, A. Schlösser. Available online at https://ec.europa.eu/newsroom/dae/document.cfm?doc_id=6917, checked on 3/10/2021.
- Reddy, V. Dinesh; Setz, Brian; Rao, G.S. V.R.K.; Gangadharan, G.R.; Aiello, M. (2017): Metrics for Sustainable Data Centers (VOL. 2; NO. 3). Available online at <https://ieeexplore.ieee.org/stamp/stamp.jsp?arnumber=7921551>, checked on 12/21/2020.
- Renda, A., Pelkmans, J., Egenhofer, C., Schrefler, L. Luchetta, G., Selçuki, C., Balesteros, J., Zirnelt, A. (2012) The uptake of Green Public Procurement in the EU27, study on behalf of the European Commission, DG Environment, prepared by CEPS and College of Europe, Brussels, 29th of February 2012, accessible from CEPS-CoE-GPP MAIN REPORT.pdf (europa.eu)
- Rivas Calvete, Silvia; Cuniberti, Barbara; Bertoldi, Paolo (2016): Effective information measures to promote energy use reduction in EU Member States. Analysis of information, empowerment and training measures in Member States National Energy Efficiency Action Plans (EUR 27997 EN). Available online at <https://publications.jrc.ec.europa.eu/repository/handle/JRC100661>, checked on 7/30/2021.
- Schödwell, Björn; Zarnekow, Rüdiger; Liu, Ran; Gröger, Jens; Wilkens, Marc (2018): Kennzahlen und Indikatoren für die Beurteilung der Ressourceneffizienz von Rechenzentren und Prüfung der praktischen Anwendbarkeit. Edited by Umweltbundesamt (Forschungskennzahl 3715 31 601 0). Available online at

- https://www.umweltbundesamt.de/sites/default/files/medien/1410/publikationen/2018-02-23_texte_19-2018_ressourceneffizienz-rechenzentren.pdf, checked on 12/30/2020.
- Shally; Sharma, Sanjay Kumar; Kumar, Sunil (2019): Measuring Energy Efficiency of Cloud Datacenters. In International Journal of Recent Technology and Engineering (IJRTE) (Volume-8 Issue-3). DOI: 10.35940/ijrte.B3548.098319.
- Shehabi, A.; Smith, S.J.; Horner, N.; Azevedo, I.; Brown, R.; Koomey, J. et al. (2016): United States Data Center Energy Usage Report. Lawrence Berkeley National Laboratory, Berkeley, California, checked on 12/24/2020.
- Smart city cluster collaboration, Task 1 (2014): Existing Data Centres energy metrics - Task 1. Edited by Seventh Framework Programme. Available online at <http://www.dolfin-fp7.eu/wp-content/uploads/2014/01/Task-1-List-of-DC-Energy-Related-Metrics-Final.pdf>, checked on 12/29/2020.
- Smart City Cluster Collaboration, Task 4 (2015): Data Centre Integration. Energy, Environmental, and Economic Efficiency Metrics: Measurement and Verification Methodology. Edited by Seventh Framework Programme.
- SNIA (2020): SNIA Emerald™ Power Efficiency Measurement Specification V4.0.0. SNIA Technical Position. Edited by SNIA Advancing storage & information technology. Available online at https://www.snia.org/tech_activities/standards/curr_standards/emerald, checked on 1/1/2021.
- SPEC (2008): SPEC Power®. Edited by Standard Performance Evaluation Corporation. Available online at https://www.spec.org/power_ssj2008/, checked on 1/14/2021.
- SPEC (2019): Server Efficiency Rating Tool (SERT) Design Document 2.0.3. Standard Performance Evaluation Corporation (SPEC®). Design Document, checked on 1/4/2021.
- Steininger et al (2017): Evaluierung des Energieausweises. Eine empirische Studie zur Wahrnehmung der Energieeffizienz von Wohnimmobilien aus der Verbraucherperspektive. Working Papers des KVF NRW 7. With assistance of Claudia Nadler, Melanie Franke, Carolin Pommeranz. Edited by Verbraucherzentrale NRW/Kompetenzzentrum Verbraucherbeforschung NRW. Düsseldorf.
- Stobbe, Lutz; Berwald, Anton (2019): State of sustainability research for network equipment. Large Network Equipment - Enterprise Switches and Routers - Final Report. Prepared for the Green Electronics Council and TÜV Rheinland in support of criteria development for the EPEAT and Green Product Mark ecolabels. Fraunhofer IZM. Berlin.
- Talens Pieró, L., Polverini, D., Ardente, F., Mathieux, F., (2020) Advances towards circular economy policies in the EU: The new Ecodesign regulation of enterprise servers, in: Resources, Conservation & Recycling, vol. 154, available at: Advances towards circular economy policies in the EU: The new Ecodesign regulation of enterprise servers - ScienceDirect
- The Green Grid (2007): Green Grid Metrics: Describing Datacenter Power Efficiency. Technical Committee White Paper, checked on 1/1/2021.
- The Green Grid (2008): A Framework for data center energy productivity. White Paper #13, checked on 1/1/2021.
- The Green Grid (2010a): ERE: A metric for measuring the benefit of reuse energy from a data center. WHITE PAPER #29. Available online at https://eehpcwg.llnl.gov/documents/infra/06_energyreuseefficiencymetric.pdf, checked on 12/29/2020.

- The Green Grid (2010b): The Green Grid Data Center Compute Efficiency Metric: DCcE. WHITE PAPER #34, checked on 1/7/2021.
- The Green Grid (2011): Water Usage Effectiveness (WUE™): A green Grid Data Center Sustainability Metric. WHITE PAPER #35, checked on 12/29/2020.
- The Green Grid (2012): Electronics Disposal Efficiency (EDE): An IT recycling metric for enterprises and data centers. WHITE PAPER #53.
- The Green Grid (2014a): Harmonizing Global Metrics for Data Center Energy Efficiency. Global Taskforce Reaches Agreement Regarding Data Center Productivity. Available online at <https://www.thegreengrid.org/en/resources/library-and-tools/215-Harmonizing-Global-Metrics-for-Data-Center-Energy-Efficiency-%E2%80%93-March-2014>, checked on 12/30/2020.
- The Green Grid (2014b): The Green Grid Data Center Storage Productivity Metrics (DCsP): Application of Storage System Productivity Operational Metrics. WHITE PAPER #58, checked on 1/1/2021.
- The Green Grid: Carbon Usage Effectiveness (CUE): A Green Grid Data Center Sustainability Metric. WHITE PAPER #32. Available online at https://www.netalis.fr/wp-content/uploads/2016/04/Carbon-Usage-Effectiveness-White-Paper_v3.pdf, checked on 12/29/2020.
- Topten Act (2018): Click your way to energy savings. TOPTEN ACT 2015-2018. Find out the most efficient products in Europe with a simple click on the Topten websites. Available online at <https://storage.topten.eu/source/files/TOPTEN-ACT-Results-Summary.pdf>.
- TÜV Rheinland and Global Electronics Council (Ed.) (2021): Criteria for the Sustainability Assessment of Network Equipment for the Global Electronics Council EPEAT® Ecolabel and the TÜV Rheinland Green Product Mark. Available online at https://globalelectronicscouncil.org/wp-content/uploads/EPEAT-Network-Equipment-Criteria_FINAL-April-2021.pdf, checked on 5/31/2021.
- UBA (2019): Marktanalyse Ökostrom II. Available online at https://www.umweltbundesamt.de/sites/default/files/medien/1410/publikationen/2019-08-15_cc_30-2019_marktanalyse_oekostrom_ii.pdf, checked on 8/6/2021.
- Vodafone (2020): Digitising Europe Pulse. Tackling Climate Change. A Survey of 13 EU Countries. Vodafone Institute for Society and Communications. Available online at https://www.vodafone-institut.de/wp-content/uploads/2020/10/VFI-DE-Pulse_Climate.pdf, checked on 3/11/2021.
- Waide, Paul; Watson, Rowan (2013): The New European Energy Label: Assessing Consumer Comprehension and Effectiveness as a Market Transformation Tool. Edited by Navigant, in collaboration with The Collaborative Labeling and Appliance Standard Program (CLASP).
- Wilde, Torsten (2018): Assessing the Energy Efficiency of High Performance Computing (HPC) Data Centers. Available online at <https://mediatum.ub.tum.de/doc/1399734/file.pdf>, checked on 1/5/2021.

Annex 1: Overview interviewed associations and companies). To create a comprehensive understanding of the various reporting systems and the benefits, barriers, and challenges, the experts were asked to provide perspectives on current practices. The results are documented below.

Purchasing of new network equipment

There are a number of metrics that describe the energy consumption and efficiency of individual network components. For example, at the level of energy consumption per port or energy consumption in idle mode. A frequently cited example of minimum requirements for components is the EU Code of Conduct for Broadband Equipment. When planning new networks and purchasing new network components, the specific values according to these metrics are requested and minimum efficiency requirements are set for the suppliers. In some cases, there are even contractual obligations that component manufacturers must take on that their equipment may not consume more than a specified amount of energy during operation. If the devices nevertheless require more energy, contractual penalties ensue.

In order to optimise the planning of networks, economic methods are also used that lead to energy savings at the same time. By calculating life-cycle costs (total costs of ownership), both the purchase price of equipment and the operating costs due to maintenance and energy consumption are taken into account. According to the network operators, the consideration of the total costs leads to a preference for the procurement of energy-efficient equipment, if for no other reason than economic considerations.

Some operators include in their planning not only the environmental impacts from “scope 1” (direct emissions) and “scope 2” (emissions from energy supply), but also the environmental impacts from “scope 3” (production of equipment and use of equipment by customers). For this purpose, the product environmental footprint methodology is applied to end-user devices, which examines the products along their entire life cycle. Since network operators often also lend or sell end devices to their customers (e.g. modems or telephones), corporate responsibility is also seen in this area, which goes beyond the actual network.

According to one network operator, the greatest energy savings are achieved through the right choice of network topology and the technology used. Through continuous modernisation, telecommunication network operators manage to keep their energy consumption constant or even reduce it, even though more data is being transmitted overall and the network is being expanded.

Operation of telecommunication networks

According to the interviewees, telecommunications network operators have a very good overview of how much energy is consumed in their networks overall. This is also because energy costs are a relevant item in the economic balance sheet. In their reporting they therefore often voluntarily show their total energy consumption and the related CO₂ emissions. According to a large telecommunications network operator, 80% of the energy consumption of the whole company results from the electricity consumption of the networks. The remaining 20% is fuel consumption of vehicles for maintenance and customer service and building energy consumption.

In addition, each network operator has corresponding statistics on how much data is transmitted over their networks. It has therefore become established as a frequently used key figure to indicate the energy efficiency of networks through the KPI energy consumption per data volume (e.g. kWh/terabyte).

However, when it comes to calculate individual network connections and, for example, the energy consumption per network service, data connection or per subscriber line, suitable calculation methods to allocate the distributed energy consumption to the individual services have been lacking up to now. Although the individual network components have the corresponding monitoring interfaces that would allow efficiency measurement at component level, the possibilities are usually not fully utilised. According to the information of an operator, this would lead to considerable additional costs and higher energy consumption due to the additional monitoring technology that would then be required. Against this background, appropriate monitoring of individual connections takes place at most within the framework of individual case studies.

In principle, all companies are obliged to carry out energy audits and introduce energy management systems according to the Energy Efficiency Directive (2012/27/EU). However, the national implementation of this obligation differs. In fact, it is easier for those network operators to collect the relevant detailed information on the energy consumption of their networks in whose countries this directive has been well implemented into national law.

In addition to the energy-related optimisation potential, efforts are also being made by telecommunications network operators in the area of resource protection. These efforts relate both to the extension of the useful life of equipment and end user devices through the refurbishment of old devices, and to the responsible handling of electronic waste.

[Suggestions of ECN operators for minimum information requirements](#)

Telecommunications network operators are very interested in reducing their energy costs and improving their environmental performance. They can be supported in this by standardised key figures and information requirements for all telecommunication network operators. Of the figures that are already regularly calculated and reported, from the perspective of the interviewed companies these three in particular could be included in a common reporting system:

- Energy consumption for the operation of the networks (geographically allocated),
- Energy consumption per amount of data transmitted (broken down by access technology, if applicable),
- Share of renewable energies in energy consumption (electricity and other energy sources).

Results from online survey with electronic communication network providers and equipment manufactureres

In the online survey mentioned in the previous chapter on Task 1.2.1, questions were also asked to assess the environmental performance of network equipment. These questions were directed towards both network operators and network equipment manufacturers.

Table 33: When asked what environmental requirements they expect or are requested for network equipment, the majority answers that they have to fulfil the requirements according to EU Code of Conduct on Energy Consumption of Broadband Equipment (67%). Another important requirement are guarantees to provide spare parts and software updates over the expected useful life (60%). About half of the companies (47%) have to meet requirements for the environmentally sustainable production as well as the obligation to take back old or defective components for refurbishment. A third of the surveyed companies (33%) have to comply with other energy consumption requirements (e.g. W/port, in different operation states) and only two companies (13%) are expecting contractual guarantees for the minimum energy efficiency.

Table 33: What requirements do you expect suppliers to meet when you procure new network equipment? What are your requirements when you offer network components?

	Count	% of responses
Requirements according to EU Code of Conduct on Energy Consumption of Broadband Equipment	10	67%
Guarantees to provide spare parts and software updates over the expected useful life	9	60%
Requirements for the environmentally sustainable production	7	47%
Taking back old or defective components for refurbishment	7	47%
Other energy consumption requirements (e.g. W/port, in different operation states)	5	33%
None of the above	3	20%
Contractual guarantees for the minimum energy efficiency	2	13%

N 15

Source: online survey with ECN providers and equipment manufacturers, multiple answers possible

The companies have listed the following **most important environmental requirements in purchasing or selling network equipment that go beyond** the above mentioned requirements:

- Banned chemical list of the Cradle to Cradle program
- Certified “green” products (e.g. Blue Angel certificate , Green Product Award, Energy Star, Eco-Rating OR equivalent)
- Commitment to develop sustainable products
- Due diligence on international regulations (e.g. WEEE, ROHS, REACH, EU directive on conflict minerals)
- Eco-design guideline according to ITU-T L.CE_2 or equivalent
- Energy efficiency according to ITU, ATIS, ETSI or equivalent
- In-house product sustainability criteria
- Life Cycle Assessment based on ITU-T L.1410 or equivalent
- Signing of a CSR clause, including environmental requirements
- Sustainable packaging (plastic-free, reusable)
- Use of recyclable materials
- Use of recycled materials in production
- WEEE targets: existing take back programs.

The companies were asked, if there is **a further need for environmental reporting standards for electronic communication networks that still need to be developed** and what these should cover. The answers vary from “no, the current standards are sufficient” to specific needs for certain environmental aspects. The main suggestions are:

- A standardised energy efficiency metric, developed by the industry (i.e. ETSI or ITU).
- Guidelines for the energy intensity calculation in electronic communications companies.
- ICT enabling impact: Reporting positive sustainability/environmental impacts of ICT because digital technologies not only consume energy and resources but also can do a lot to enable its customers and the society to reduce energy and resource consumption and to decrease carbon emissions.
- No! The number of standards is exponentially increasing already. Unless you produce a standard with little complexity, well written, don't even try...
- Not to be used to compare different operators but more as a way to measure their footprints over time.
- Social topics as human rights in the supply chain etc.
- Technology neutrality should be included in any standards used.
- There are a wide range of environmental reporting standards currently available which are fit for purpose.
- There is a need for standardization in how sustainable materials are (EPDs ISO14044 based).
- We do not see a need for further regulatory intervention.
- We see also increasing interest within circular economy topics.
- With respect to climate change also science based targets, renewable energy targets and carbon neutrality targets are increasingly expected.

As a final question the companies were asked, **how electronic communications providers could contribute to the European Green Deal to achieve climate neutrality in 2050**. 13 companies responded to this question, some of them in great detail, and referred to further documents and additional statements. In the following, the individual contributions of the companies and assessments are summarised, whereby the points mentioned first are the most frequently mentioned:

- Almost all responding companies emphasise the special role of digital transformation in achieving the goals of the European Green Deal. Telecommunication can help to reduce traffic, transform the energy system and produce more efficiently (“**enabling effects**”). The expansion and increased use of electronic infrastructure is already a contribution in itself.
- Frequently mentioned are the efforts of companies to become **climate-neutral themselves**. This shall be achieved in particular by purchasing **electricity from renewable energies**.
- Several mentions refer to the **efficiency advantages of certain technologies** (FTTH and 5G). The expansion of highly efficient technologies should make the digital infrastructure reliable and future-proof. In doing so, it should also be accepted that initially higher investments and possibly higher environmental burdens will be incurred, but that these will then pay off in the future.

- In another direction, various contributions argue that **existing infrastructures** (copper cables) should be used for **as long as possible** and should be adapted to the increasing data demand through upgrades. This prevents **expensive road works** and increases the useful life of electronic components, which is seen as a contribution to resource conservation.
- Several proposals refer to the **sharing of infrastructures** among different, competing providers. By sharing infrastructures, parallel investments are avoided and infrastructures are better utilised. This leads to cost savings and greater efficiency.
- Other individual mentions include **increasing the energy efficiency of network components** by improving **sleep modes** when not in use.
- More **efficient cooling technologies**, which still account for around 40% of energy demand.
- The introduction of **CO₂ taxes for electricity**, which should further strengthen the self-interest of companies to save energy.
- **Dismantling of mobile phone infrastructures** and increased use of the more energy-efficient fixed network infrastructures.
- The **reduction of material consumption** and e-waste generation through longer useful lifetimes and better take-back systems.
- Introduction of **rental systems for end user devices** (device as a service), which guarantee an orderly take-back of the devices.
- Use of **recycled materials** in and **better recyclability** of devices.
- Moving away from flat-rate tariffs to **billing tariffs** that take into account the amount of data. This should encourage consumers and device manufacturers to consume less data.

Task 1.2.3: Standards and measurement methodologies for the monitoring of environmental footprint of electronic communications networks and services

Aim of this task

The key objective of this task is to provide comprehensive information on existing standards (or such under development) and measurement methodologies for monitoring the environmental footprint of electronic communication networks and services.

The scope of this task includes the standards and measurement methodologies for monitoring the environmental footprint, particularly with regard to energy consumption and GHG emissions. In the following sections only ECN-relevant standards are described, i.e. equipment on the end-user side, is not part of this task.

Figure 20: Scope of the ECN to be covered in dotted lines

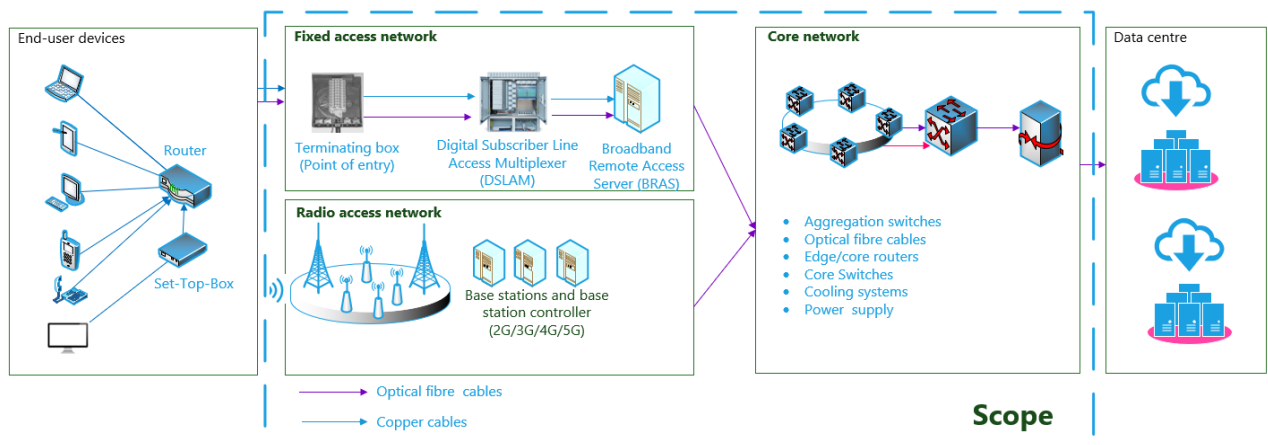

Source: Oeko-Institut

Categorisation of networks and their electricity consumption



Networks are highly complex systems. Basically, a network can be classified as follows:

- By generations of technology:
 - legacy,
 - modern and
 - next generation
- By communication medium and type of services provided:
 - fixed network
 - mobile network
- By hierarchy levels:
 - access network,
 - aggregation network (also called metro network)
 - core network (also called backbone network)

The intermediate layer between two respective access networks, the so-called aggregation network, transports data between the interconnected nodes. EDNA (2019) pointed out that it is becoming increasingly difficult to distinguish the boundary between the aggregation and core networks. Hence, according to the EDNA study the aggregation network is considered part of the core network which is shown in Figure 21.

For both fixed and mobile networks, the JRC study on the best environmental management practice (BEMP) in the telecommunications and ICT services sector found that the access network can be a major energy consumer due to the presence of a large number of active elements (Canfora et al. 2020). Furthermore, radio base stations (RBS) are the dominant part of the total energy consumption of a wireless access network (ITU-T L1310 and (Al-Shehri et al. n.d.)

Figure 21: Categorisation of networks differing technology generations and network segments

	Legacy /Traditional	Modern	Next Generation (NG)
Fixed Access Network (FAN) 	ADSL (asymmetric digital subscriber line)	VDSL (very-high-bit-rate digital subscriber line) PON (passive optical network)	XG PON
Radio Access Network (RAN) 	2G (GSM) 3G (WDCMA)	4G (LTE, LTE+)	5G
Core WAN 	PSTN (public switched telephone network) core, Metro and backhaul	Fibre optic	SDN (software defined network) NFV (network functions virtualisation)

Source: Oeko-Institut based on EDNA (2019)

The FAN (Fixed access network) uses thousands of kilometres of electric copper cables and optical fibres to ensure communication. The RAN (Radio access network) connects mobile devices to the internet by using radio wave transmissions (ranging widely from 3 kHz to 300 GHz) as signals (Canfora et al. 2020). The core networks are the main internet highways which connect RAN and FAN over long distances between different regions and cities with high data volumes.

The energy consumption modelling of the WAN (wide area networks) carried out by EDNA (s. Figure 22) shows that the core network only consumes a small fraction, around 13% of the total WAN energy. Most energy is consumed to get into the network (access network). The forecast shows that WAN energy consumption will decrease in the period 2014 to 2022 and then slowly increase thereafter, based on assumptions of the “high efficiency scenario”. It is predicted that the energy consumption of RAN (radio access network) will overtake the demand for energy by FAN (fixed access network) in the future (EDNA 2019). The use of 2G and 3G networks is expected to decline over time. It should be emphasized that projections are based on various assumptions and uncertainties remain, as it is unclear to what extent efficiency improvements can be achieved.

Figure 22: Global energy consumption by category of WAN

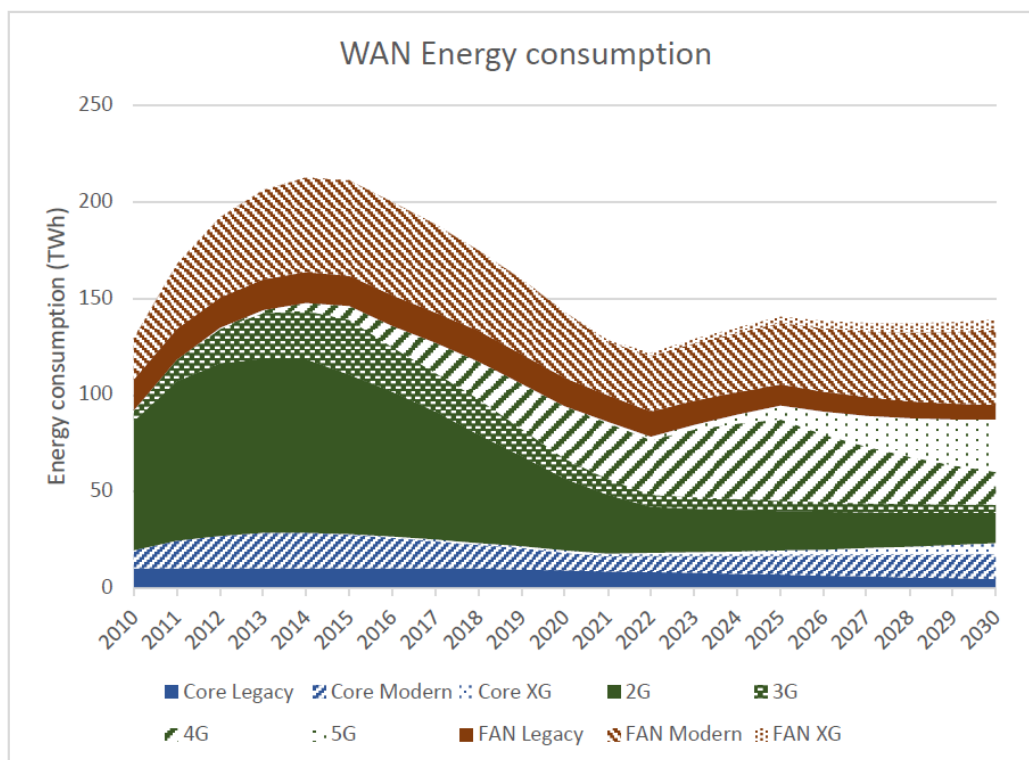

Source: EDNA (2019), Page 49

The study by Gröger and Liu (2021) investigated the power consumption of network components along the path from the access network via the aggregation network to the core network and further to the data centre. For this purpose, a data stream of 2.2 Mbps was calculated, which proportionally requires the network components along the transmission path and to which a share of the respective energy consumption of the components is assigned. If the total power consumption for this data transmission is taken as a reference, the proportional energy consumption for each network component is obtained. Table 34 shows this as a value in percent.

Table 34: Power consumption of network components along a 2.2 Mbps data stream (in %)

Component	VDSL	FTTH	4G	5G
Network Access Unit	80%	49%	67%	81%
Network Access Terminal	14%	25%	32%	15%
Broadband Network Gateway	2.1%	9.4%	0.4%	1.2%
Aggregation Switch	1.3%	5.7%	0.2%	0.7%
Core Router	1.5%	6.5%	0.3%	0.8%
Inline Amplifier	0.7%	3.1%	0.1%	0.4%

Datacenter Broadband Network Gateway	0.3%	1.1%	0.0%	0.1%
Total	100%	100%	100%	100%

Source: Data calculated from Gröger and Liu 2021

When a data stream is transmitted, the **majority of the energy consumption takes place in the access network**. The *network access unit* and the *network access terminal* (see Table 34) together account for between 74 percent (FTTH) and 99 percent (4G) of the respective energy consumption.

ITU-T L.1470 (01/2020) also quantified the electricity consumption and greenhouse gas (GHG) emissions for the year 2015 and made estimates for 2020, 2025 and 2030 for the global ICT sector, including data centres, networks, end-user devices (ITU-T L-1470 2020). Figure 23 shows the selected results associated with the global network sector. It is estimated that the total electricity consumption of networks worldwide will continue to increase. After the base year 2015, the electricity consumption of mobile networks is expected to still dominate the entire network (mobile and fixed networks, including manufacturing). The global electricity consumption associated with manufacturing the mobile network equipment is predicted to increase. In contrast, the energy consumption of fixed networks is estimated to be relatively constant from 2020 to 2030. The tracking report by IEA 2020 indicated that energy efficiency of data transmission networks has improved rapidly. It was estimated that networks consumed around 250 TWh in 2019. Mobile networks account for two-thirds of them. Electricity consumption is projected by IEA report to rise to about 270 TWh in 2022.

Figure 23: Electricity consumption of global networks including manufacturing and operation

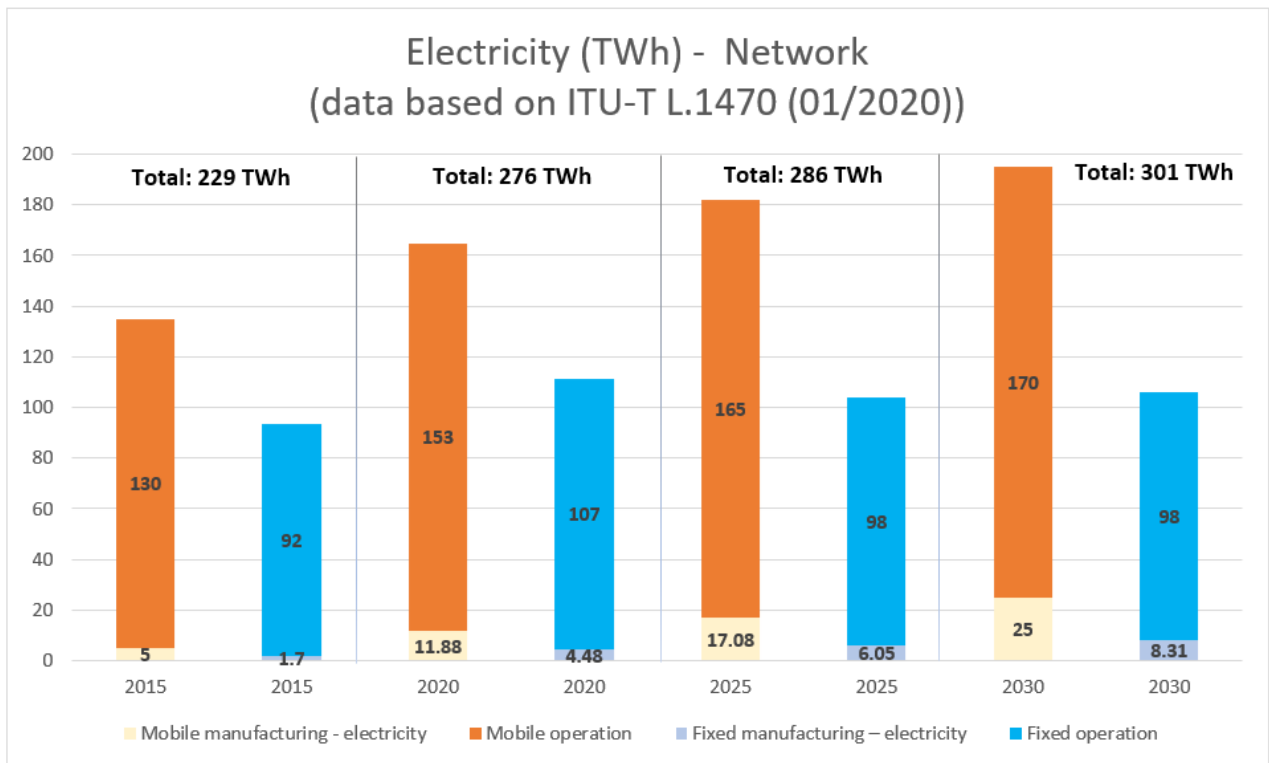

Source: Oeko-Institut based on ITU-T L.1470, Annex A: Analysis of ICT sector and sub-sectors trajectories

Energy efficiency metrics concerning the networks, ITU-T L.1315 *Standardization terms and trends in energy efficiency* and ITU-T L.1310 *Energy efficiency metrics and measurement methods for telecommunication equipment* indicate that an energy efficiency metric can be defined at three levels:

- Energy efficiency at network level, which evaluates the energy efficiency of an entire network or parts of it, e.g. the access network, or mobile network. Hence, all equipment used to build the investigated telecommunication network should be considered.
- Energy efficiency at equipment and system level, which is mostly used to compare telecommunication equipment of the same technology and similar configuration.
- Energy efficiency at component level, which evaluates the energy efficiency or energy consumption of individual components. Component-level metrics can help to identify the hot spots of energy use of each component without considering the context of the overall equipment.

This classification is used for the following section to distinguish metrics and methodologies for the ECN, especially at the network level and at the equipment/system level. The component level is not relevant for this task.

Existing standards and methodologies in terms of energy and environmental footprint of ECN

This task focuses on standards and methodologies for monitoring the environmental footprint of electronic communications networks and services, particularly energy consumption and GHG emissions. A desk research was conducted.

SMART 2011/0073 (Mudgal et al. 2013) commissioned by DG CONNECT analysed diverse methodologies and initiatives for accounting and reporting of GHG emissions for ICT sector. ICT-specific methodologies/initiatives in terms of telecommunication networks and services are:

- GHG Protocol¹³⁷ is the common methodological framework applied by companies, when they disclose their scope 1, 2 and 3 GHG emissions regarding the Carbon Disclosure Project (CDP). With the framework of GHG Protocol, the ICT Sector Guidance for Telecommunication Networked Services (TNS)¹³⁸ (GHG Protocol ICT Sector Guidance 2017) was developed to provide guidance and calculation methods for assessing GHG emissions of for example service platform involving network equipment and infrastructure used by the service provider to deliver the TNS.
- ITU-T Rec. L.1410 (12/2014) and ETSI ES 203 199 V1.2.1 as a “Methodology for environmental life cycle assessments of information and communication technology goods, networks and services” were developed jointly by ETSI TC EE and ITU-T Study Group 5. It was published respectively by ITU and ETSI as Recommendation ITU-T L.1410 (ITU-T L.1410 2014) and ETSI Standard ES 203 199 (ETSI ES 203 199 V1.2.1), which are technically-equivalent.

These methodologies are based on the life-cycle thinking (i.e. cradle-to-grave). GHG Protocol assesses only greenhouse gas emissions, while the method by ITU and ETSI consider besides climate change as a required category, also other optional environmental impact categories, e.g. ozone depletion, human toxicity.

Network components are usually shared by different services. An important step in the assessment of network services is the allocation of the environmental impact of the network to the specific service under consideration. Allocation is a very challenging step while calculating shared resources (transmission nodes, core nodes etc.) and further GHG, since data is often not known. For instance, different telecommunication services are hosted in parallel in the same access networks or network equipment shared by different virtual services.

According to the GHG Protocol ICT Sector Guidance – TNS, apportionment may be based on, for example:

- Usage-based allocation, for example, number of subscribers or amount of data

¹³⁷ Greenhouse Gas Protocol (GHG Protocol) was jointly convened in 1998 by World Business Council for Sustainable Development (WBCSD) and World Resources Institute (WRI).

¹³⁸ ICT Sector Guidance built on the GHG Protocol Product Life Cycle Accounting and Reporting Standard, Chapter 2: Guide for assessing GHG emissions Telecommunications Network Services (TNS)

- Provisioned capacity, for example, ports or bandwidth
- Mean traffic across a network or equipment

For different network layers, different allocation methods may be appropriate.

ETSI ES 203 199 V1.2.1 (2014-10) and ITU-T Rec. L.1410 recommend a top-down approach, i.e. it is in most cases more practicable to calculate the overall energy consumption of a network than to calculate the energy consumption per service. The following allocation principle of ICT Network data to an ICT Service shall be used based on (ETSI ES 203 199 V1.2.1; ITU-T L.1410 2014) in terms of networks:

- As for access networks, control and core nodes and operator activities: access/active use time is preferred for circuit-switched networks and data traffic is preferred for packet-switched networks. Data traffic is also preferred for e.g. mobile access networks as mobile access networks show a large dependency between data traffic and energy consumption and need a traffic model that takes data traffic into account.
- As for transport equipment: allocation shall be conducted based on data traffic.
- As for data centres and service provider activities: allocation shall be based on number of subscriptions and service users or amount of data/transactions

Allocation requirements are described in the methodologies. However, more practical research on application is needed to examine whether the allocation rules can be actually applied in the reality.

The following standardization bodies and institutions are crucial for the development of standards and measurement methodologies in terms of energy and environmental impacts of ECN:

- ITU: International Telecommunication Union
The International Telecommunication Union (ITU) is the United Nations specialized agency in the field of telecommunications, information and communication technologies (ICTs). The ITU Telecommunication Standardization Sector (ITU-T) Study Group 5 (SG5) is responsible for studies on methodologies for evaluating ICT effects on climate change and for the publication of guidelines for the eco-friendly use of ICTs¹³⁹.
ITU recommendations are available for free.
- ETSI: European Telecommunications Standards Institute
ETSI is recognized as a European Standards Organization that supports European regulations and legal provisions by creating harmonised European Standards. ETSI creates specifications (e.g. Technical Specifications TS; Group Specifications GS), standards (e.g. European Standard EN, ETSI Standard ES), reports (e.g. Technical report TR, Special Report SP) and guidelines (e.g. ETSI Guide). ETSI Standards can be downloaded free of charge.

¹³⁹ <https://www.itu.int/en/ITU-T/about/groups/Pages/sq05.aspx>

- ATIS: Alliance for Telecommunications Industry Solutions

ATIS is a standards organisation that develops standards and technical specifications as well as guidelines in the US. The ATIS standards are not available for free. We therefore only focus on ETSI and ITU methodologies. The standards and specifications of ETSI and ATIS are assumed to be harmonised as both are organizational partners of 3GPP (3rd generation partnership project¹⁴⁰). The last mentioned provides a stable environment for its members to produce reports and specifications on mobile communication technologies.

Due to different characteristics and the complex landscape of telecommunication networks and network services, the standards and methodologies are categorised at first. The detailed description of each considered methodology can be found in [Annex 8: Task 1.2.3 Standards and measurement methodologies for the monitoring of environmental footprint of electronic communications networks and services](#). Table 35 gives an overview over these methodologies.

Table 35: Overview of specific ECN-relevant ITU and ETSI methodologies

Level	Environmental aspects covered	Network segment covered	Title
At network level	operational energy / power	Mobile network	ITU-T L.1330 (03/2015): Energy efficiency measurement and metrics for telecommunication networks
			ITU-T L.1331 (09/2020): Assessment of mobile network energy efficiency ETSI ES 203 228 V1.3.1 (2020-10): Assessment of mobile network energy efficiency ¹⁴¹
	<ul style="list-style-type: none"> operational energy / power energy associated with maintenance activities 	Network infrastructure	ITU-T L.1332 (01/2018): Total network infrastructure energy efficiency metrics
	operational energy / power	Fixed broadband access networks	ETSI EN 305 200-2-2 V1.2.1 (2018-08): Access, Terminals, Transmission and Multiplexing (ATTM); Energy management; Operational infrastructures; Global KPIs; Part 2: Specific requirements; Sub-part 2: Fixed broadband access networks
	operational energy / power	Mobile broadband access networks	ETSI EN 305 200-2-3 V1.1.1 (2018-06): Access, Terminals, Transmission and Multiplexing (ATTM); Energy management; Operational infrastructures; Global KPIs; Part 2: Specific requirements; Sub-part 3: Mobile broadband access networks
	operational energy / power	Mobile Core network and Radio Access Control	ETSI ES 201 554 V1.2.1 (2014-07): Measurement method for energy efficiency of Mobile Core network and Radio Access Control equipment

¹⁴⁰ <https://www.3gpp.org>

¹⁴¹ ITU-T L.1331 and ETSI ES 203 228 are technically equivalent.

Level	Environmental aspects covered	Network segment covered	Title
At equipment and system level	Operational energy / power	Mobile network: base station site	ITU-T L.1350 (10/2016): Energy efficiency metrics of a base station site
	Operational energy / power	Mobile network: radio access network	ETSI EN 303 472 V1.1.1 (2018-10): Energy efficiency measurement methodology and metrics for RAN equipment
	Operational energy / power	Mobile network: access equipment	ETSI ES 202 706-1 V1.6.0 (2020-11): Metrics and measurement method for energy efficiency of wireless access network equipment; Part 1: Power consumption - static measurement method
	Operational energy / power	Mobile network: access equipment	ETSI TS 102 706-2 V1.5.1 (2018-11): Metrics and measurement method for energy efficiency of wireless Access Network Equipment; Part 2: Energy Efficiency - dynamic measurement method
	Operational energy / power	Fixed network	ETSI EN 303 215 V1.3.1 (2015-04): Measurement methods and limits for power consumption in broadband telecommunication network equipment
	Operational energy / power	Fixed network: all the transmission equipment connected to the network by means of wired medium (i.e. copper or fiber), typically running at the network OSI level 1 and OSI level 2	ETSI ES 203 184 V1.1.1 (2013-03): Measurement methods for Power Consumption in Transport Telecommunication Networks Equipment
	Operational energy / power	General networks	ITU-T L.1310 (09/2020): Energy efficiency metrics and measurement methods for telecommunication equipment
	Operational energy / power	General networks: routers and switches	ETSI ES 203 136 V1.2.1 (2017-10): Measurement methods for energy efficiency of router and switch equipment
	Operational energy / power	Virtualized network functions and infrastructure	ITU-T L.1361 (11/2018): Measurement method for energy efficiency of network functions virtualization ETSI ES 203 539 - V1.1.1 (2019-06) - Environmental Engineering (EE); Measurement method for energy efficiency of Network Functions Virtualisation (NFV) in laboratory environment ¹⁴²
	Management of WEEE calculation of recycling and recovery rates	General ICT equipment	ETSI EN 305 174-8 V1.1.1 (2018-01): Access, Terminals, Transmission and Multiplexing (ATTM); Broadband Deployment and Lifecycle Resource Management; Part 8: Management of end of life of ICT equipment (ICT waste/end of life)

Source: Oeko-Institut

¹⁴² ITU-T L.1361 and ETSI ES 203 539 are technically equivalent.

Table 36 specifies the corresponding metrics applied in ITU and ETSI methodologies

Table 36: Description of metrics applied in ITU and ETSI methodologies

Level	Network and Equipment	Title	Metrics used
At network level	Mobile network:	ITU-T L.1331 ¹⁴³ (09/2020) ETSI ES 203 228 V1.3.1 (2020-10)	<ul style="list-style-type: none"> Mobile network (MN) data energy efficiency ($EE_{MN,DV}$) [bit/J]: the ratio between the data volume (DV_{MN}) and the energy consumption (EC_{MN}) Mobile network coverage energy efficiency ($EE_{MN,CoA}$) [m^2/J]: the ratio between the area covered by the MN under investigation and the energy consumption when assessed for one year Latency based metric ($EE_{MN,L}$) [ms^{-1}/J] is the inverse ratio of the end-to-end user plane latency and the energy consumed by the MN. Site energy efficiency (SEE): the ratio between the ratio of "IT equipment energy" and "Total site energy" including rectifiers, cooling, storage, security and IT equipment. Provides a method to extrapolate the assessment of energy efficiency from sub-network to total networks based on demography (5 classes: dense urban, urban, suburban, rural, unpopulated), topography (3 classes: Flat, Rolling, Mountainous) and climate classifications (5 classes: Tropical, dry, temperate, cold, polar).
	Total network infrastructure	ITU-T L.1332 (01/2018)	<p>Total network infrastructure energy efficiency definition (NIEE):</p> <p>The ratio between ICT load energy consumption and total energy consumption of the network. When reporting metric values, network site owners should use the average NIEE measured over a one-year period to get an averaged value.</p>
	Fixed broadband access networks	ETSI EN 305 200-2-2 V1.2.1 (2018-08)	<p>KPI_{EM} consists of KPI_{EC}, KPI_{TE} and KPI_{REN}</p> <ul style="list-style-type: none"> KPI of energy consumption, KPI_{EC} [Wh]: total energy consumption by fixed access network site (Operator Site, Network Distribution Node sites, Last Operator Connection sites) KPI for task effectiveness, KPI_{TE} [bits/Wh] The ratio between the data volumes (both upstream and downstream data) and KPI_{EC} KPI for renewable energy contribution, KPI_{REN} [%] Share of renewable energy generated on-site at Operator Site, Network Distribution Node sites, Last Operator Connection sites
	Mobile broadband access networks	ETSI EN 305 200-2-3 V1.1.1 (2018-06)	<p>KPI_{EM} consists of KPI_{EC}, KPI_{TE} and KPI_{REN}</p> <ul style="list-style-type: none"> KPI of energy consumption, KPI_{EC} [Wh]: total energy consumption by fixed access network site (Operator Site, Network Distribution Node sites)

¹⁴³ ITU-T L.1331 Assessment of mobile network energy efficiency is regarded as an advanced version of ITU-T L.1330. ITU-T L.1331 introduces new requirements for 5G New Radio (NR). ITU-T L.1330 (03/2015) is therefore not represented to avoid repetition. The detailed description can be found in the Annex.

Level	Network and Equipment	Title	Metrics used
			<ul style="list-style-type: none"> KPI for task effectiveness, KPI_{TE} [bits/Wh] The ratio between the data at base stations and KPI_{EC} KPI for renewable energy contribution, KPI_{REN} [%] Share of renewable energy generated on-site at Operator Site, Network Distribution Node sites
	Mobile Core network and Radio Access Control equipment	ETSI ES 201 554 V1.2.1 (2014-07)	<p>Energy Efficiency Ratio (EER) [Erlang/W PPS/W Subscribers/W SAU/W]:</p> <ul style="list-style-type: none"> The ratio between useful output and average power consumption. Useful output can be the number of Erlang (Erl), Packets/s (PPS), Subscribers (Sub), Simultaneously Attached Users (SAU) Average power consumption is measured at low, medium, and high load levels.
At equipment and system level	At base station site	ITU-T L.1350 (10/2016)	<p>Site energy efficiency (SEE) [%]:</p> <p>The ratio between the total energy consumption of telecommunication equipment and the total energy consumption on site consisting of electric energy from the public grid and locally produced electrical energy.</p>
	Base stations (BS)	ETSI EN 303 472 V1.1.1 (2018-10)	<ul style="list-style-type: none"> Capacity energy efficiency KPI ($KPI_{EE-capacity}$) [Mbits/Wh]: The ratio between data volume of the BS and the total energy consumption of the BS site including the support infrastructure Coverage energy efficiency KPI ($KPI_{EE-coverage}$) [km²/Wh]: The ratio between coverage area of the BS and the total energy consumption of the BS site including the support infrastructure Site energy efficiency KPI ($KPI_{EE-site}$) [%]: The ratio between the total energy consumption of all the BS equipment at the site and the total energy consumption of the BS site Extended BS total renewable energy KPI ($KPI_{REN-tot}$) [%]: the fraction of the electricity used by an extended BS site that has been supplied by renewable resources Extended BS on-site renewable energy KPI ($KPI_{REN-onsite}$) [%]: The fraction of electricity generated from renewable energy at a site vs. the total electricity generated at a site
	Base stations under static test conditions	ETSI ES 202 706-1 V1.6.0 (2020-11)	Average power consumption [W] is measured with pre-defined and fixed three load levels (low, medium, busy-hour loads) under given reference configuration. And daily energy consumption [Wh] of BS is calculated.
	LTE Base stations under dynamic test conditions	ETSI TS 102 706-2 V1.5.1 (2018-11)	<p>Base Station Energy Efficiency (BSEP) [bits/Wh]:</p> <p>The ratio between the measured data volume in bits for low, medium and busy-hour load level and the total energy consumption of the base station which results from the weighted energy consumption for each traffic level i.e. low, medium and busy-hour traffic.</p>
	DSLAM DSL, MSAN, GPON OLT and Point to Point OLT equipment.	ETSI EN 303 215 V1.3.1 (2015-04)	<p>Power consumption per port of broadband network equipment, P_{BBport} [W/port]:</p> <p>Power consumption (in W) of a fully equipped broadband network equipment, measured at the electric power input interface pro maximum number of ports served by the broadband network equipment</p>

Level	Network and Equipment	Title	Metrics used
	The transmission equipment connected to the network by means of wired medium	ETSI ES 203 184 V1.1.1 (2013-03)	Transport Equipment Energy Efficiency Ratio (EEER) [Mbps/W]: <ul style="list-style-type: none"> The ratio between total capacity of a defined configuration (the sum of the interface data rates [Mbps]) and power consumption of a defined configuration [Watt]. The power consumption considers three different levels of load (0%, 50%, 100%)
	•DSLAM, MSAM GPON GEAPON equipment ¹⁴⁴	ITU-T L.1310 (09/2020)	P_{port} [W/port]: the power (in watts) of a fully equipped wireline network equipment with all its line cards working in a specific profile/state pro maximum number of ports served by the broadband network equipment
	•Wireless access technologies: Radio base stations (RBS) at static load: GSM, UMTS and LTE	ITU-T L.1310 (09/2020)	energy efficiency metric at RF (radio frequency) unit level, EE_{RFU} : The ratio between daily RF output energy consumption [Wh] under different loads and daily RF units energy consumption [Wh] under different loads (low, medium, busy-hour loads)
	•Wireless access technologies: LTE RBS at dynamic load	ITU-T L.1310 (09/2020)	Energy efficiency of an RBS [bits/Wh]: The ratio between the work done in terms of delivered bits to the UEs and the consumed energy for delivering these bits.
	•Routers, Ethernet switches	ITU-T L.1310 (09/2020)	Energy efficiency rating (EER) [Mbit/s/W]: <ul style="list-style-type: none"> The ratio between weighted throughput [Mbit/s] and weighted power [W] Power and throughput measured at respective utilization levels (3 levels) depending on routers and switches.
	•WDM/TDM/OTN transport MUXes ¹⁴⁵ /switches	ITU-T L.1310 (09/2020)	Transport Equipment Energy Efficiency Ratio (EEER) [Mbps/W] (the same as ETSI ES 203 184)
	•Converged packet optical equipment	ITU-T L.1310 (09/2020)	Energy Efficiency Ratio (EER) [bps/W]: <ul style="list-style-type: none"> Maximum throughput per average power consumption. Average power consumption is measured power consumption (W) at a 0% and 100% data traffic utilization
	• Core, edge and access routers • Ethernet switches	ETSI ES 203 136 V1.2.1 (2017-10)	Energy Efficiency Ratio of Equipment (EEER) [Gbps/Watt] The ratio between Total weighted throughput and the weighted power for different traffic loads (low, medium and high)
	Network functions virtualization (NFV)	ITU-T L.1361 (11/2018) ETSI ES 203 539 - V1.1.1 (2019-06)	<ul style="list-style-type: none"> The VNF (virtualized network functions) energy efficiency ratio (EER) [bps/W PPS/W Subscribers/W]: The ratio between useful output and power consumption. The useful output can be throughput (e.g. bps), packet per second (PPS), or capacity (e.g. number of subscribers or sessions) The VNF (virtualized network functions) resource efficiency ratio (RER) [bps/W PPS/W Subscribers/W]:

¹⁴⁴ digital subscriber line access multiplexer (DSLAM), multiservice access node (MSAN), gigabit passive optical network (GPON) and gigabit Ethernet passive optical network (GEAPON), Optical Line Termination (OLT)

¹⁴⁵ wavelength division multiplexing (WDM), Time Division Multiplex (TDM), Optical Transport Network (OTN), Multiplexer (MUX)

Level	Network and Equipment	Title	Metrics used
			<p>The ratio between useful output and resource consumption.</p> <p>Resource consumption of virtual machines (VMs) is specified as CPU capacity, total memory used, total storage used and the sum of average network throughput of bytes transmitted and received per second.</p> <ul style="list-style-type: none"> The NFV infrastructure (NFVI) energy efficiency ratio (EER) the ratio of useful output of VNFs and power consumption of NFVI platform with VNF deployed
	WEEE within ICT sites, core and access networks	ETSI EN 305 174-8 V1.1.1 (2018-01)	Recycling and recovery rates [%] based on the weight of the WEEE

Source: Oeko-Institut

A useful work concept for network equipment according to ITU-T L. 1315 (05/2017) or ETSI Standard ETSI ES 203 475 v1.1.1 (2017-11) is depicted in Figure 24.

Figure 24: Useful work concept for ICT based on ITU T-L 1315 and ETSI ES 203 475: Standardization terms and trends in energy efficiency

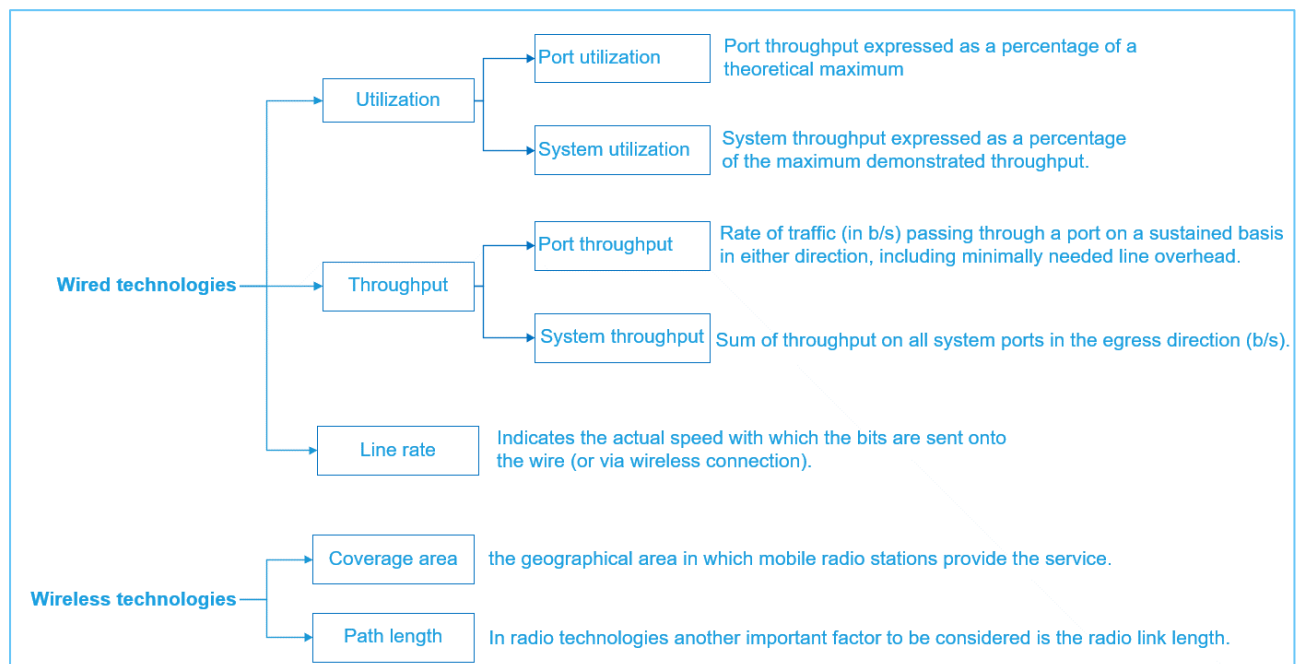

Source: Oeko-Institut

In terms of end-user perspective, ITU-T L.1315 also lists some indicators describing the “useful work” related to the applications to a network. That could be:

- Number of users,
- Service per user,
- Level of oversubscription,
- Total network egress traffic,

- Combinations of the above.

ETSI ES 201 554 V1.2.1 (2014-07) and ITU-T L. 1361 (11/2018) specify that useful output could be expressed as Subscribers (Sub) or Simultaneously Attached Users (SAU) also for functions which normally have the maximum capacity expressed in Erlang¹⁴⁶ (Erl) or Packets/s (PPS).

Task 1.2.4: Assessment of the suitability of indicators from consumer perspective

Aim of this task

The focus of this task is to investigate the suitability of possible indicators for electronic communications services, in view of communicating them to end-users, who could make informed choices on their service provider and on their service consumption.

Methodological approach

In order to achieve a transformation of the telecommunications sector towards energy-efficient and environmentally friendly products, several approaches are possible in principle (see Figure 25). The figure shows the hypothetical distribution of products of different sustainability on the market. The aim of governance instruments is to increase the number of sustainable products and thus - figuratively speaking - to shift the curve to the right. The instruments act at different points of the distribution curve. Firstly on the left side, by setting minimum requirements for market entry (e.g. ecodesign). Secondly in the middle in the mainstream market (with the most products) by transparency measures and product labelling requirements (e.g. energy efficiency labels) to trigger competition between products and companies. Thirdly on the right side by highlighting innovative practices (e.g. through eco-label) and targeted promotion of green technologies (e.g. through green public procurement).

¹⁴⁶ Erlang: Average number of concurrent calls carried by the circuits (ITU-T L.1361, Clause 3.2.5)

Figure 25: Policy mix for more sustainable products

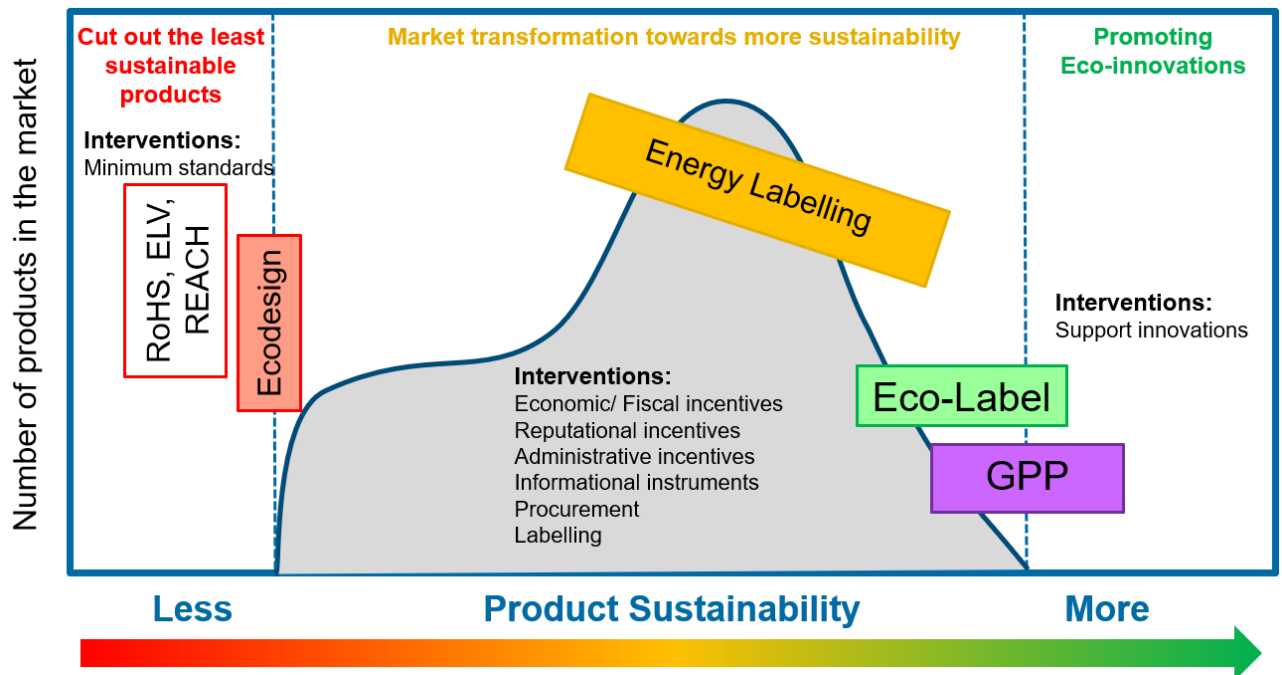

Source: Oeko-Institut based on European Commission, DG Environment

In creating more transparency, a distinction can be made between company-wide approaches on the one hand (e.g. CSR reports), which primarily target business customers and financial investors, and approaches that target individual products and their consumers on the other hand. The effectiveness of the latter point (consumer decision) is linked to certain preconditions that must be fulfilled.

Technical preconditions are:

- Existing methodologies and standards to monitor and calculate the environmental impacts of telecommunication products (task 1.2.3 of this study),
- significant difference of energy (or environmental) performance in the range of products (which can only be answered when there is a sufficient number of benchmarks of the same product category that allow a comparison to be made),
- technical feasibility of providing information in the level of detail (granularity) required by consumers (early feedback from telecom providers suggests that it is very difficult to allocate the company's total energy consumption to individual services, as the main energy consumption consists of a base load and the additional consumption for individual services is lost in the overall noise.),
- consumer has a choice of different products, between which he can easily and regularly select.

Furthermore, there are several consumer-related preconditions. Such preconditions can be derived from the evaluation of previous policy practice, especially the EU Energy Label which has been extremely well researched. Core preconditions are:

- Consumers view energy efficiency / energy savings in that product as a relevant characteristic and potential purchase criterion.

- For home appliances, this has repeatedly shown to be the case - presumably due to a long history of campaigning by various state and NGO actors in combination with the fact that significant amounts of money could be saved. (forsa 2009; Waide and Watson 2013)
- For electronics, the relevance of energy efficiency has been shown to be lower, because functionality and novelty aspects are weighted higher. (Consumer Focus 2012)
- Functionality (or other consumer relevant properties) is similar for products that differ in their energy / environmental performance levels (that is, energy efficiency or other positive environmental properties are interesting as an “add-on” if the core functionality is fulfilled). (Ipsos MORI et al. 2012)
- The information about energy performance is communicated in a simple and visually appealing way. For the EU Energy label, it has been shown that the colour coding in combination with the alphabetical class names have been the decisive success factor (London Economics and IPSOS 2014; Ipsos MORI et al. 2012; Molenbroek et al. 2013; Waide and Watson 2013). The ease of recognition of the efficiency classes directs consumer choice even in cases where there is little actual difference in energy performance (Andor et al. 2017).
- The information is communicated by a trusted source (forsa 2009; Waide and Watson 2013).

The research therefore focuses on the question of how these core preconditions can be met by a label or metric for telecommunication services. The choice of the exact indicator should be a sub-question of the question, how information can be presented in a simple and visually appealing way.

Desk research

In the literature many studies can be found on how to raise energy awareness in different target groups. For this study we focused on the Precede-Proceed planning model Green and Kreuter (1999) for developing policy interventions that was adapted by Egmond et al. (2005) for energy related behaviour. The model consists of three phases:

- Phase 1: diagnosing the relevant changes in behaviour and environment to meet policy goals;
- Phase 2: assessing the corresponding determinants;
- Phase 3: choosing the matching instruments.

The intention to save energy was found to be formed by predisposing factors, like awareness, knowledge, norms, attitude and self-efficacy (Rivas Calvete et al. 2016). They are further influenced by so called “enabling factors” like financial resources, technical resources, new skills and intensified or weakened by “reinforcing factors” feedback from peers, advice from experts, subsidies and regulations from authorities. Policies reach their goals if they are able to correctly identify the action point and the susceptibility of their information targets. Rivas Calvete et al. (2016) mentions three classical approaches:

- the price-based approach: save money;
- the environmental approach: save the planet
- and the social approach: be a good citizen.

Following Egmond's (2005) model, the objective should first be identified. The objective of a consumer-oriented policy instrument would be that consumers:

- Choose the most energy-efficient network connection (e.g. fibre if available).
 - Intended impact: Telecommunications service providers should be motivated by the eventually stronger demand from consumers for more energy-efficient connections compared to less efficient connections to design their network connection technology to be energy-efficient as quickly as possible and thus gain a market advantage. In this context, it is certainly necessary to consider how much optimisation potential the respective connection types offer in themselves (e.g. potentially more energy-efficient technology for the provision of a cable connection for a provider who specialises in cables) and which technological leaps are thus virtually predetermined, depending on local availability.
- Select a provider that offers services in a particularly energy-efficient way (indicator e.g. energy consumption per hour telephoning, energy consumption per Gigabyte data transfer etc.).
 - Intended impact: Telecommunications service providers should be motivated to design the technology required for the services offered as energy-efficiently as possible or, if they are not responsible for the technologies themselves, to work towards making them as energy-efficient as possible. In this way, they can present themselves to their customers as best practice.

How energy-efficient the respective solutions are or which more or less high annual electricity consumption the two decisions lead to has no influence on the electricity consumption and the electricity bill of the consumers themselves. Electricity consumption only takes place at the telecommunications service provider or in the network. In this respect, consumers do not feel any consequences of their decision, which a policy instrument could potentially link to. For example, a presentation of costs or cost savings would not be possible. However, it would be possible to build on the increasing awareness of the dangers of climate change and thus achieve a willingness to act on the part of consumers. European Commission (2019a) found for EU28 that 79% of European citizens think that climate change is a very serious problem, an increase of five points since 2017. A share of 60% of respondents say they have personally taken action to fight climate change in the past six months, an increase of 11 points since 2017.

In another recent survey commissioned by the European Commission (2021b) specifically on e-communications, respondents were asked whether the environmental footprint of communication services would have an impact on their choice of the provider or whether this would influence their usage behaviour. 44 percent of around 27 thousand respondents from 27 member states answered that they would definitely (10%) or probably (34%) take this information into account. 51 per cent, on the other hand, said they would definitely not (19%) or probably not (32%) consider such information. Five percent of the respondents answered "do not know".

According to Egmond and Bruel (2007) policy instruments that focus on information and promotion – like a potential energy label for telecommunication services that is introduced with a large campaign – have a primary effect on awareness and attitudes of their target group (in

this case consumers). As second effect is that they also influence knowledge, subjective norms and self-efficiency.

Decision-making environment: The decision for a specific network connection (e.g. DSL) is a decision that is not often made by consumers. Typical occasions are a move or the arrival of a previously unavailable network technology in the neighbourhood with a potentially higher benefit than previously available technologies (e.g. fibre). Consumer research (Define 2017, Hurtado and Paralera 2016) has shown that for consumers, the network connection technology itself is not a priority in their decision for a specific tariff. Rather, the price-performance ratio of the telecommunication providers' tariffs with the parameters price, speed, reliability, capping, bundling of services counts. In general, consumers have a low level of knowledge in this area and do not want to spend more time than absolutely necessary choosing the most suitable tariff for them. Given the confusing variety of many different tariffs with difficult to compare services and bundling, it is cumbersome for consumers to decide.

How do consumers make their decision for a broadband connection?

From two studies that could be identified on the purchase decision of consumers on broadband (Define (2017) for UK, Hurtado and Paralera (2016) for Spain) the following conclusions can be drawn:

- For consumers it is difficult and cumbersome to compare the different broadband offers and to take the decision for the most beneficial offer.
- Consumers are not engaged in broadband and usually have a low knowledge level. Consumers consider broadband as an utility that should work in the background but should not need further attention.
- From the perspective of consumers, a broadband service should meet the needs of consumers at the best price. Criteria that reflect the needs of consumers are reliability, speed, data allowances and bundles (e.g. internet and TV). Price is the most important single criterion.
- The type of connection, e.g. fibre, seems not to be of priority for consumers decision.
- Energy efficiency, energy consumption, greenhouse gas emissions or other environmental impacts seem not to be related to consumer's decisions. Doubts must be raised that consumers do connect energy consumption etc. at all to broadband.

Against this background it will not be easy to inform end-users concerning energy efficiency for broadband. In order to communicate environmental information together with broadband services, it will therefore be important to deliver very simple and intuitively understandable information to consumers.

Possible approaches to communicate the environmental footprint of electronic communications networks and services

[Reporting at company level](#)

One approach that many electronic communications network providers already follow with their annual reports (see Task 1.2.1) is to disclose how much energy they consume in total as a company, what is their share of renewable energies and which CO₂ emissions are related to this. For this purpose companies refer mainly to the Global Reporting Initiative (GRI),

Greenhouse Gas Protocol (GHGP) or the results of energy management according to ISO 14 001 or ISO 50 001 as suitable methods of accounting.

- **Annual energy consumption of the company** [MWh/a]
If applicable, further differentiated by energy source (e.g. electrical energy, district or local heating, diesel, petrol, etc.) and geographical allocation of business operations (e.g. per country).
- **Share of renewable energies in annual energy consumption** [%]
If applicable, further differentiated according to type of renewable energy source (electricity from hydropower, wind power, photovoltaics, solar heat, biomass).
- **Annual CO₂ emissions of the company** [tonnes CO₂-eq/a]
If applicable, further differentiated by geographical allocation of business operations (e.g. per country)

These figures would provide a good basis for getting to know the energy consumption of the electronic communications networks and services sector better and for compiling central statistics. The goal of achieving climate neutrality in this sector could then be monitored, for example by regulatory authorities. For consumers themselves, however, these figures are not very meaningful, as they do not allow for a comparison of companies and do not provide any information on the efficiency or environmental friendliness of their business model (except perhaps for the share of renewable energy).

Reporting at the level of subscribers

In order to access the internet or make telephone calls, there are several technical access options, each of which require different amounts of energy (mobile telephony of different generations, fixed network access with fibre optics, VDSL, broadband cable). The customer of this service decides which provider to contract and which access technology to use. The analysis of the energy consumption of a data transmission along the different network levels shows that the highest energy consumption per data volume takes place in the access network (see Figure 22 and Table 34). When a data stream is transmitted the *network access unit* and the *network access terminal* together account for between 74 percent (FTTH) and 99 percent (4G) of the energy consumption for the whole data transfer. To reduce the complexity of calculating the energy consumption of data transmission, information could therefore (at first) only be provided on the energy consumption of the access network. This would already make it possible to distinguish between different access options (e.g. broadband cable or fibre optics) and different providers.

Box 7: Reference units in the formation of key figures (e.g. subscribers or service units)

By using reference units, key figures can be presented in such a way that they are intuitively understood by end-users. For example, energy consumption is easier to understand if it is related to a single product and its use over a period of one year, rather than to a company as a whole or to a large number of activities. In the methodology of life cycle assessment (ISO 14040), a "functional unit" is chosen for this purpose, which describes the scope for the environmental impacts of a product as precisely as possible. The same procedure must be chosen for the indicators proposed here. If "per subscriber" or "per service unit" is

mentioned here, it must be determined in the development of methodology for the specific key figure (which exceeds the present study) which physical quantities this respective reference value comprises. For example, a "subscriber" could be defined on the basis of average values of all telecommunication customers in a certain time period, describing a certain amount of transmitted data, online times, connections and number of connected devices. This reference functional unit must be defined uniformly and taken into account in the same way by all ECN providers when calculating the key figures. The same procedure is used for the reference values that refer to the service units. For example, for 1 hour of video streaming, it must be specified which data volume is transmitted during one hour (e.g. 2 GByte/h) or with which screen resolution is streamed (e.g. full-HD 1920 x 1080 pixel). Even if in individual cases the service is used with less data transmission, the uniform reference values make it possible to compare the efficiency of different services with each other.

The simplest way to express this environmental footprint of a electronic communication network is to disclose the average electrical power consumption of the access network. To distinguish between different access technologies, the power consumption per customer can be given by the provider, for example "6 Watts per subscriber" (hypothetical number) for a VDSL-Access (more examples see Figure 26). At the level of the aggregation network and the core network, the technology is shared between different network access technologies and sometimes even between different providers, so it is not possible to allocate the energy consumption directly to different customers. These shared infrastructures will have to be allocated by a general approach, possibly by the transmitted data.

- **Power consumption of access network per subscriber [W]**

Differentiated by network access technology (e.g. UMTS, LTE, 5G, Satellite, VDSL, FTTH, Cable). Calculated for example from the total power consumption of the access network per technology divided by the number of customers per technology

Although this "per subscriber" approach seems simple and plausible at first glance, there are also some difficulties and concerns about whether it can really represent the efficiency of a telecom provider well. As described in Box 7, it is important to define a suitable "functional unit", which in the case of a "subscriber" could be an average user or a user with a defined data volume and online times.

In order to realise an appealing presentation of these numerical values for consumers, the respective watt values (power consumption of the service per subscriber) or other efficiency values (e.g. energy intensity or carbon footprint of data transmission) could be put into a colour scale, comparable to the well-known EU energy efficiency label. For example, the following values would be possible as a distinction:

Figure 26: Example for energy efficiency label for access network

Energy efficiency colour scale	E.g. Power consumption of the service per subscriber	E.g. Energy intensity of data transmission	E.g. Carbon footprint of data transmission
	< 1 Watt	< 1 Wh/GByte	< 1 g CO ₂ -eq/GByte
	< 2 Watt	< 2 Wh/GByte	< 2 g CO ₂ -eq/GByte
	< 4 Watt	< 4 Wh/GByte	< 4 g CO ₂ -eq/GByte
	< 8 Watt	< 8 Wh/GByte	< 8 g CO ₂ -eq/GByte
	< 16 Watt	< 16 Wh/GByte	< 16 g CO ₂ -eq/GByte
	< 32 Watt	< 32 Wh/GByte	< 32 g CO ₂ -eq/GByte
	≥ 32Watt	≥ 32 Wh/GByte	≥ 32 g CO ₂ -eq/GByte

As supplementary information, this label could additionally indicate the type of access technology, the upload and download speed and the share of renewable energy.

Reporting at the level of services

A further level of detail could be given by the information of the environmental footprint per service unit. If one follows a data stream from the consumer to the data centre (and back again), a number of network components are used, which in turn consume energy. Some companies already describe their energy consumption by the so-called "energy intensity", which represents the energy consumption per amount of data transmitted [kWh/GB]. By using the respective service for the amount of data, this calculation is also possible at service level: energy consumption per hour of telephony, per hour of video call or per hour of video streaming.

Companies could therefore select from a catalogue of possible services those that they predominantly offer and calculate the energy consumption associated with each service. If new services are invented (e.g. the processing of voice messages through speech recognition), the ECNs must determine the amount of data transmitted and specify the energy consumption in the network.

- **Energy** consumption per service unit [Wh/Service_unit]
 - Voice telephony [Wh/h]
 - Video telephony [Wh/h]
 - Video streaming [Wh/h]
 - Data transmission [Wh/GB]

Survey of consumer organisations on the suitability of environmental indicators for telecommunications services

In order to assess whether the introduction of environmental indicators for telecommunication services will have a positive impact on consumers' purchasing decisions towards greener electronic services, an online survey was conducted among European consumer organisations. The national member organisations of the European Consumer Organisation BEUC (Bureau Européen des Unions de Consommateurs) were invited to participate in this survey. A total of 10 organisations took part in the online survey. The organisations represent the interests of consumers in the EU member states Austria, Belgium, Denmark, Germany, Greece, Lithuania, Netherlands, Portugal, Slovenia, Spain, and additionally the candidate country North Macedonia. Within the EU member states, this represents around 45 per cent of the EU-population. For this reason, the results should be considered indicative. No private consumers were directly interviewed. With the representatives of the consumer organisations, it was ensured that the survey could take place in a qualified manner. In the following the results from the survey will be presented. The survey questions can be found in Annex 3: .

Detailed results by question

The first question aimed to find out whether consumer organisations consider environment-related information provision on electronic communications services to be useful at all. The question and its answers can be found in Figure 27.

Figure 27: Do you consider information to consumers on the environmental footprint of electronic communications services to be an effective way for achieving a reduction in the energy consumption of the electronic communications services?

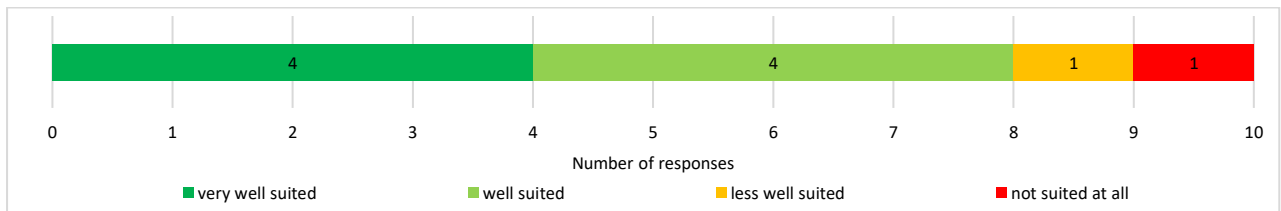

Source: online survey with consumer organisations

For 8 of the 10 participating consumer organisations, information to consumers on the environmental footprint of ECS is *very well* or *well suited* for achieving a reduction in the energy consumption of the electronic communications services. Two out of 10 do not consider this a suitable approach to reduce energy consumption (*less well suited* and *not suited at all*).

The consumer organisations added as explanations to their responses that consumers are willing to proactively contribute to a green transition. In order to do so they need reliable information and choices. Consumer information is not sufficient, as it must be accompanied by mandatory measures for the information technology sector. Overall, it is not sure if consumers change their provider on the basis of corresponding information:

- “Consumer surveys demonstrate that there is a clear interest by consumers to personally engage in the green transition; lack of reliable information on environmental performance of products and services come as a major obstacle in this regard.”

- “If consumers have a real choice, then information put forward in an easy understandable and non-overflowing manner may help them make decisions that help the green transition.”
- “Information about the energy consumption of ICTs to raise awareness makes sense, but it is no substitute for mandatory requirements for the ICT sector to operate in an energy-saving way and without fossil fuels.”
- “We don't expect that many consumers will switch provider as a result of this information.”

The decision in favour of a service provider takes place on the basis of various criteria. The next question in Figure 28 asks for the different aspects in the selection process.

Figure 28: In your opinion, what is the role of the following aspects in consumers' decision to choose a particular electronic communications service (e.g. mobile operator or internet service provider)?

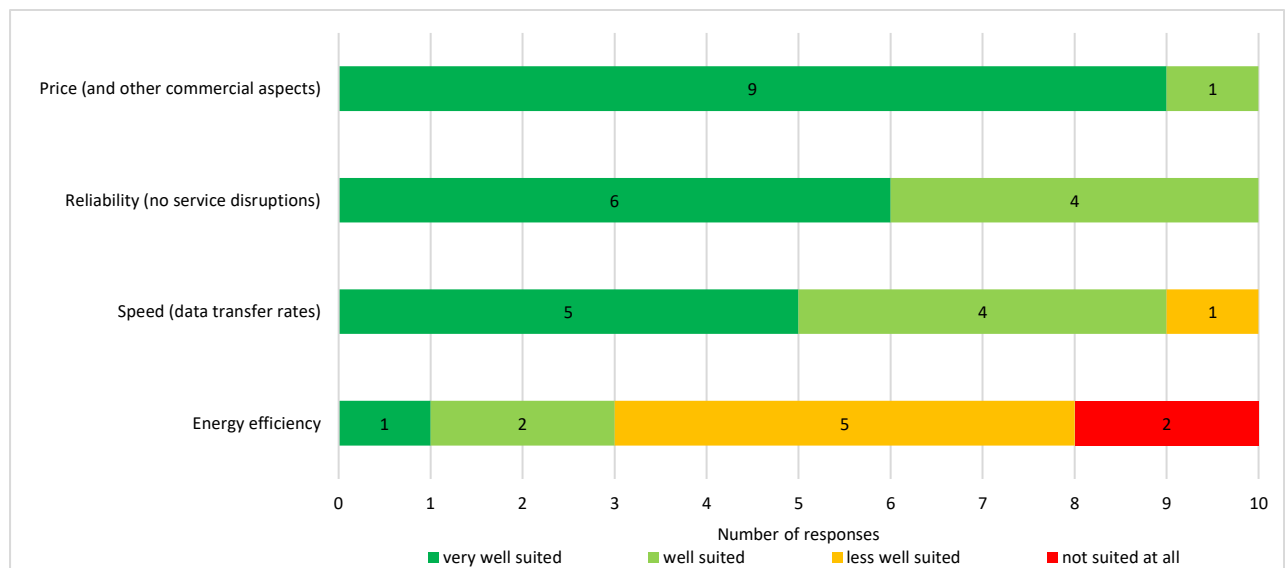

Source: online survey with consumer organisations

The most important aspects for consumers when choosing a particular ECN provider is the *price* (9/10 *very well* and 1/10 *well suited*). Next important aspect is the *reliability of the service* (6/10 *very well* and 4/10 *well suited*). *Speed of data transfer (data transfer rate)* follows (5/10 *very well*, 4/10 *well* and 1/10 *less well suited*). And finally, *energy efficiency* is clearly seen as much less important, as only 3 out of 10 find it either *very well suited* (1/10) or *well suited* (2/10). Five out of 10 consumer organisations find energy efficiency *less well suited* and 2 out of 10 *not suited at all* for choosing an electronic communications service.

Additionally, two aspects for choosing an electronic communications service were mentioned as *well suited* by two of the respondents:

- “After sales service and support”
- “Cheap offers of mobile phones in combination with the telecommunication contract”

Information on the environmental impacts of a telecom service could be provided on different levels. For example, on the level of the whole company that provides the service. In this case,

a company can present on a corporate level what efforts it is making to reduce its environmental impact (e.g. average values across all customers). One level below is the presentation of the respective environmental impacts at the level of services (e.g. internet access via fibre, mobile access via 4G). If a company offers several services, this value would differ per service. Other reference units for the respective environmental impacts are also conceivable (e.g. service units, such as 1 hour of use of a service). Consumer organisations were asked at which level the environmental information should be provided (see Figure 29).

Figure 29: To which level should the information on environmental impacts refer?

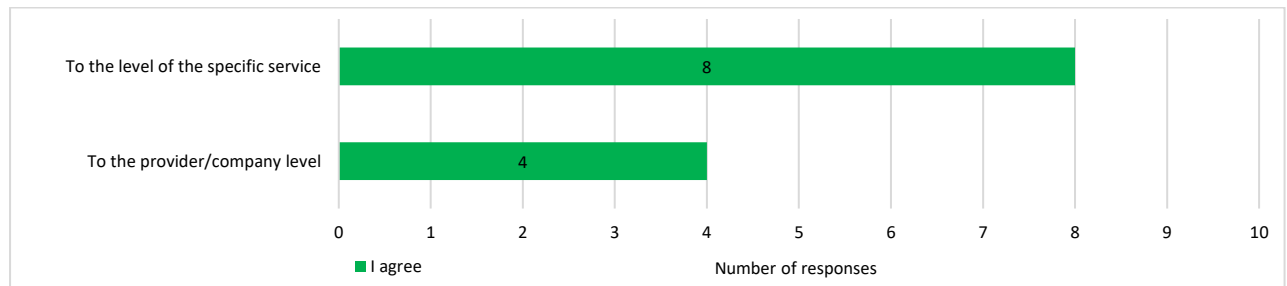

Source: online survey with consumer organisations

Concerning the level of information, eight out of 10 consumer organisations indicated that it should refer to the *specific service*, while four organisations tie it also to the level of the *provider or company* (double mentions possible). One organisation added as options that *network level* and the level of the *individual internet provider* should be addressed as well.

The next question was about the suitability of different indicators for consumer information so that they can be understood by consumers (see task 1.2.3).

Figure 30: How understandable do you think the following environmental indicators on electronic communications services are for consumers?

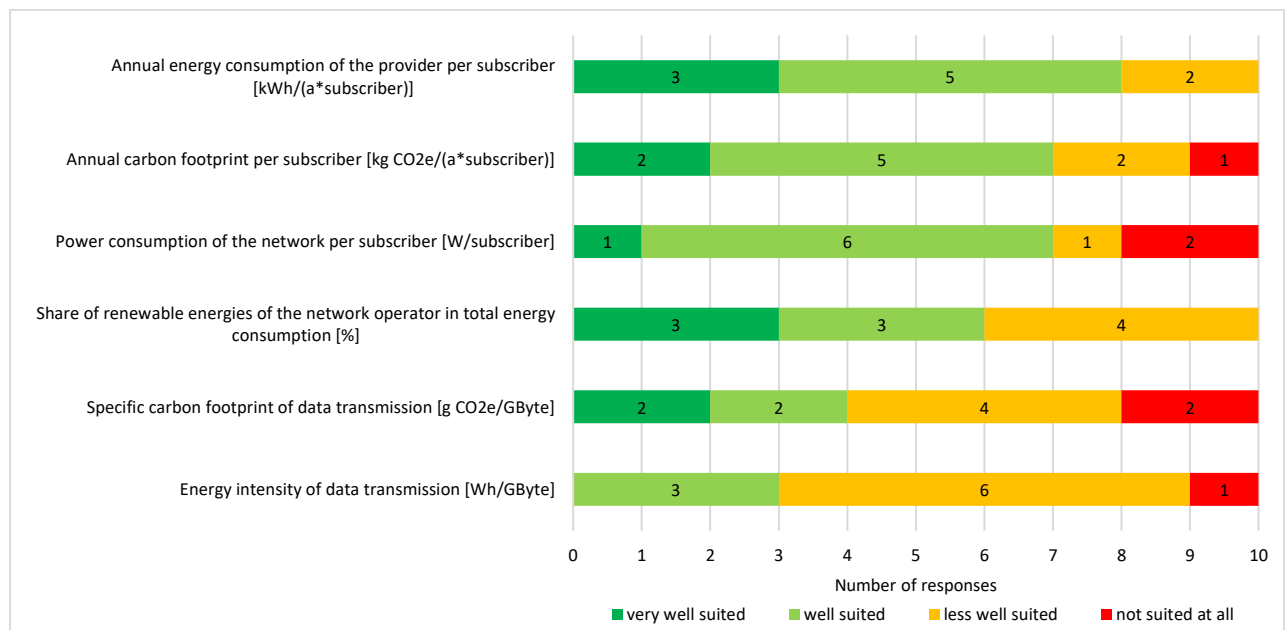

Source: online survey with consumer organisations

Eight out of 10 consumer organisations think that the *annual energy consumption of the provider per subscriber* is *very well* (3/10) or *well suited* (5/10). No organisation thinks that this level of information is *not suited at all*. Seven out of 10 consumer organisations see the *annual carbon footprint per subscriber* (2/10 *very well* and 5/10 *well suited*) and the *power consumption of the network per subscriber* (1/10 *very well* and 6/10 *well suited*) as an understandable information for consumers. Six out of 10 consumer organisations suppose the *share of renewable energies* of the network operator in total energy consumption as *very well* (3/10) or *well suited* (3/10). No organisation deemed the share of renewables *not to be suited at all*. The *specific carbon footprint of data transmission* was expected by 4 out of 10 organisations as an understandable indicator (2/10 *very well* and 2/10 *well suited*). And finally the *energy intensity of data transmission* was seen by only 3 out of 10 consumer organisations as *well suited* while 7 out of 10 expected this option to be *less well suited* (6/10) or even *not suited at all* (1/10).

Regardless of what information is provided, we asked the consumer organisations where the environmental information should be provided (see Figure 31).

Figure 31: Where should such information on the environmental indicators of communications services be provided?

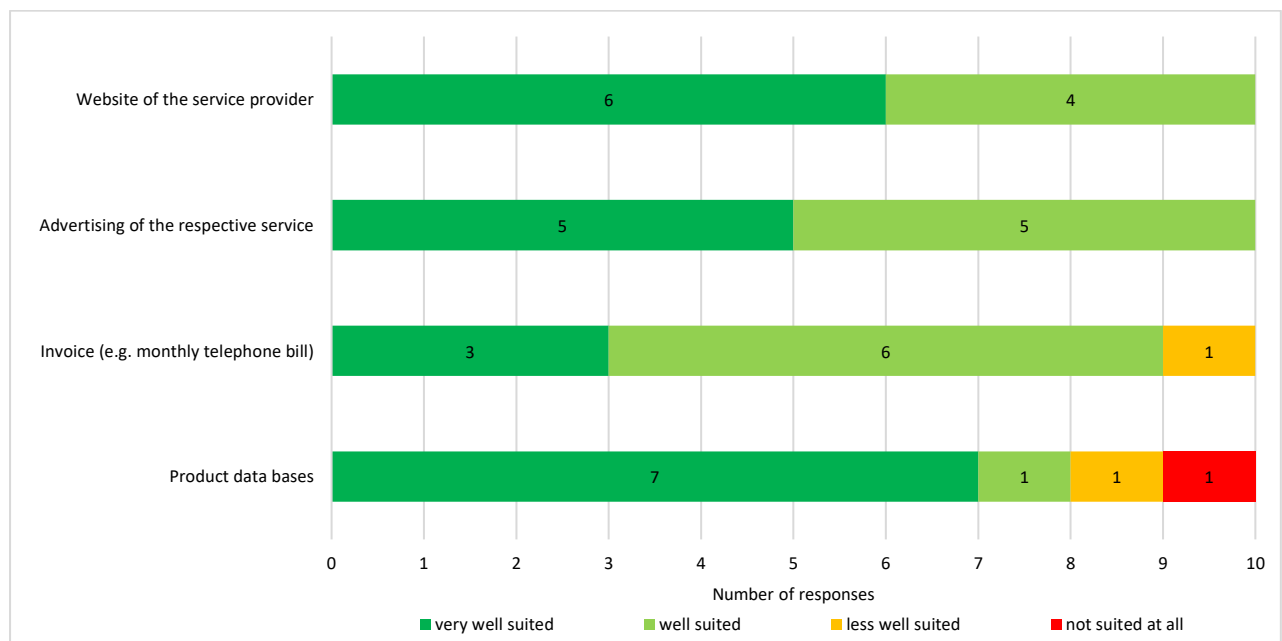

Source: online survey with consumer organisations

According to the participating consumer organisations such information should be provided on the *website of the service provider* (6/10 *very well* and 4/10 *well suited*), in *advertisings of the respective service* (5/10 *very well* and 5/10 *well suited*) and/or on *the invoice* (3/10 *very well* and 6/10 *well suited*). The suggestion of product databases as a source of information shows greater diversity in the responses. They are seen as *very well suited* by 7 out of 10 organisations and *well suited* by 1 of the participants of the online survey whereas one organisation find it *less well suited* (1/10) and one *not suited at all* (1/10).

In the area of household appliances, the presentation of the energy efficiency of products on the basis of the EU energy label is already a well-known practice among consumers. Particularly efficient products are labelled with an "A" and a green bar, while particularly inefficient products are labelled with a "G" and a red bar. An example for an energy efficiency label for access networks (equivalent to Figure 26) was shown to the participants of the online survey as an example of a possible representation. The following question aims to find out whether this type of consumer communication could also be transferred to telecommunications services (Figure 32).

Figure 32: Do you think a colour coded label would help consumers to take energy efficiency into account when deciding on a specific service?

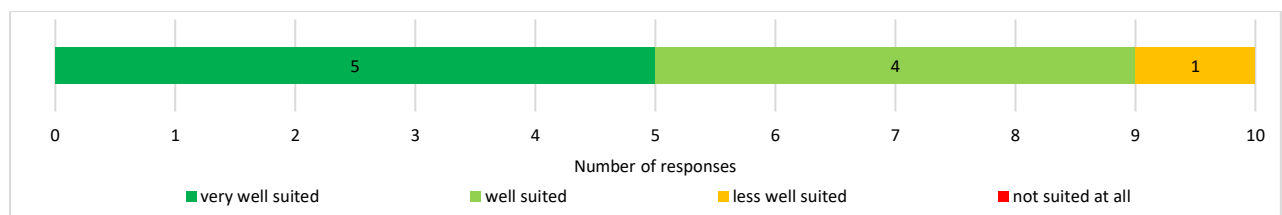

Source: online survey with consumer organisations

Nine out of 10 participating consumer organisations find that a *colour coded label* would be *very well* (5/10) or *well suited* (4/10) to display the energy efficiency of fixed internet or mobile service.

In additional remarks, consumer organisations expressed their support for the colour coding because of following reasons:

- “A colour scale makes decision making more simple for consumers”
- “familiarity” of consumers with colour codes
- “If criteria are well defined and communicated the well-known colour scale is very suitable tool to display energy efficiency of service providers. We only have to bear in mind future revisions following the improvements in technology (similar to the new energy label for household devices)”

In addition to the colour-coded energy efficiency label for telecommunication services, further measures can possibly be taken to increase its impact. For this purpose, the question in Figure 33 was asked.

Figure 33: What additional information or measures could enhance the effect of such colour coding?

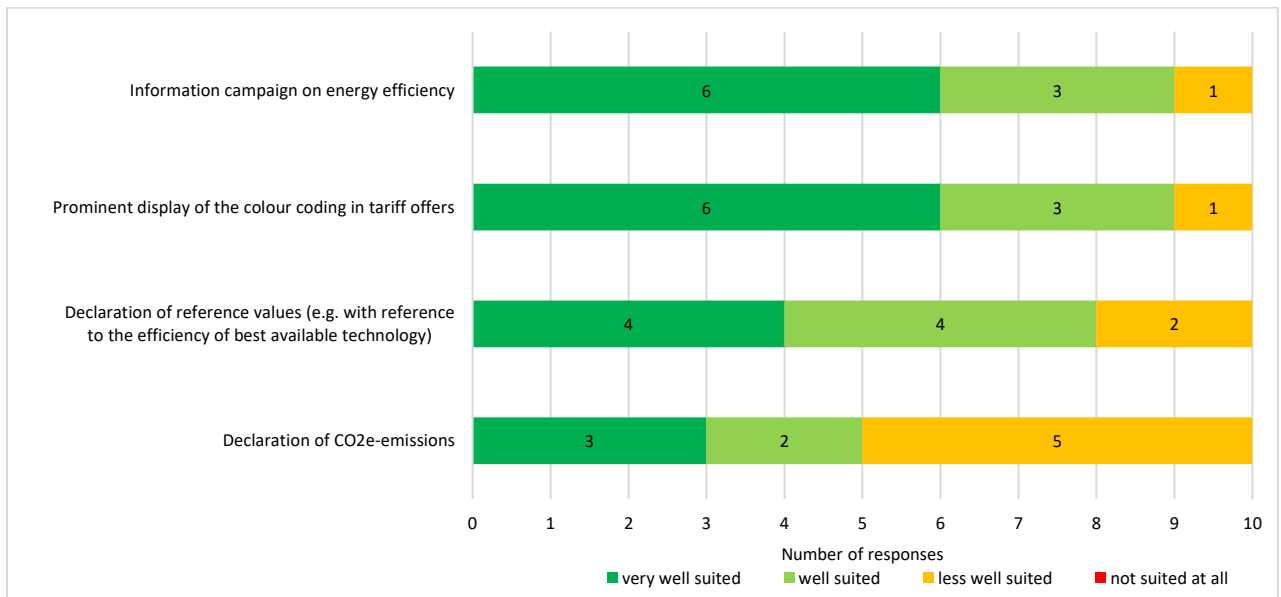

Source: online survey with consumer organisations

The effect of such a colour coding could, in the opinion of the consumer organisations, be enhanced by an *information campaign* and as well the *prominent display of the colour coding in tariff offers* (each 6/10 *very well* and 3/10 *well suited*). The *declaration of reference values* is also seen by 8 out of 10 consumer organisations to have an enhancing impact as they were voted as *very well suited* (4/10) and *well suited* (4/10). The *declaration of CO₂ equivalent emissions* is considered to be suitable by only 5 out of 10 as *very well* (3/10) and *well suited* (2/10) while the other half expects CO₂ values to be *less well suited* (5/10).

In order to give the respondents the opportunity to also name the disadvantages of environment related consumer information, a question was also asked about potential risks (Figure 34):

Figure 34: Do you see potential disadvantages or risks for consumers if information on environmental footprint of services is introduced?

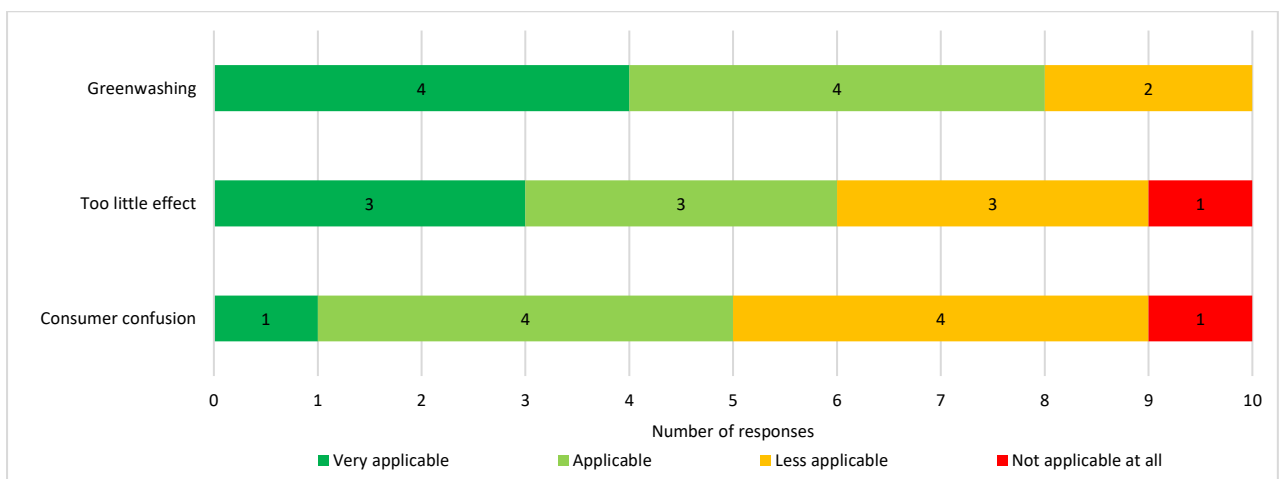

Source: online survey with consumer organisations

The highest risk connected to the display of environmental information on electronic communications services, according to the consumer organisations responds, was perceived to be *greenwashing*. Eight out of 10 participating consumer organisations think that this risk is *applicable* (4/10) and *very applicable* (4/10). Six out of 10 think such information has *too little effect* with the answers *applicable* (3/10) and *very applicable* (3/10). Half of the participants fear that from such information could result *consumer confusion* with this risk being *applicable* (4/10) and *very applicable* (1/10).

Figure 35: Which instruments do you think could be most suitable to improve the environmental footprint of communication services?

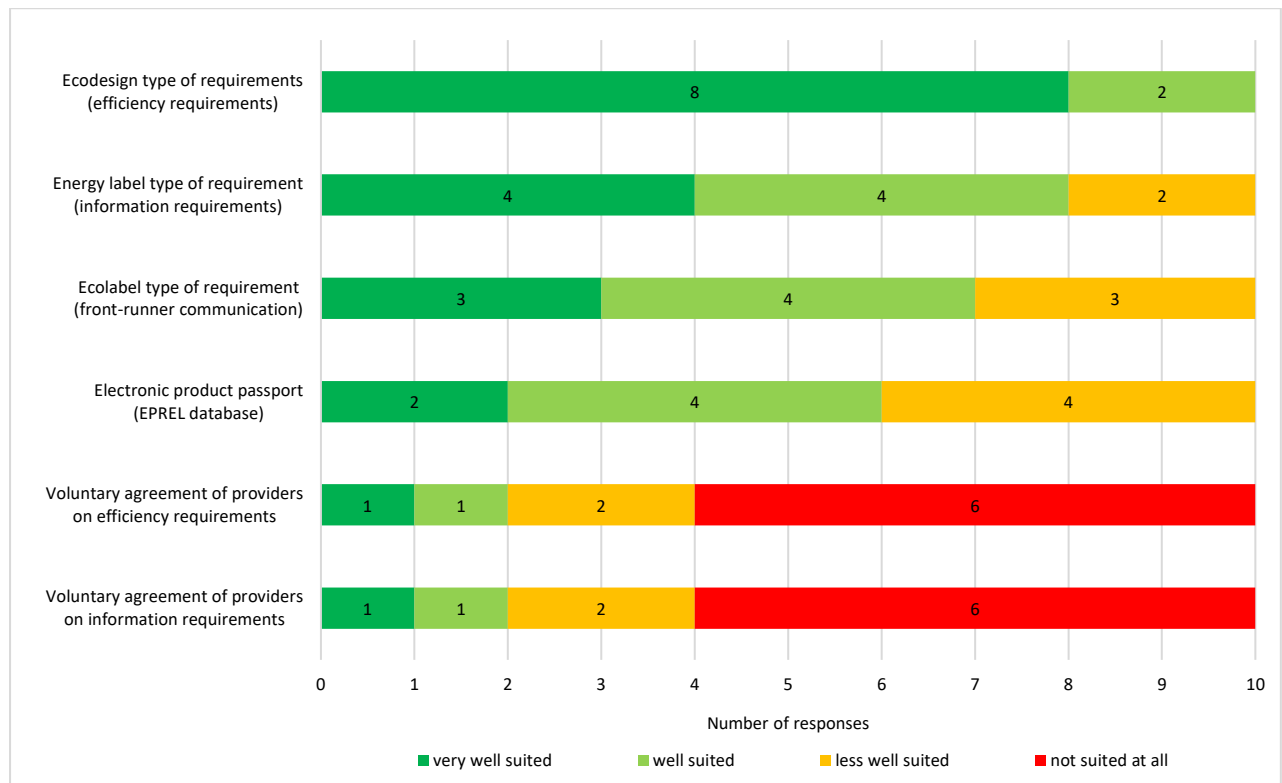

Source: online survey with consumer organisations

All of the ten consumer organisations surveyed stated that *Ecodesign type of requirements* are the most suitable instrument to improve the environmental footprint of electronic communications services (8/10 *very well* and 2/10 *well suited*). Eight out of 10 think that *energy label type of requirements* are *very well* (4/10) or *well suited* (4/10), followed by 7 votes for *Ecolabel type of requirement* (3/10 *very well* and 4/10 *well suited*). An *electronic product passport* would be appreciated by 6 out of 10 consumer organisations with the answers of 2/10 *very well* and 4/10 *well suited*. In contrast, *voluntary agreements of providers on efficiency requirements* or *information requirements* were seen as not sufficient by 8 out of 10 organisations with *not suited at all* (6/10) and less well suited by 2 out of 10.

The last question to consumer organisations was formulated as an open question and had a broader focus: **What would be your suggestion to move forward to more sustainable communication services?**

Several organisations mentioned the legislation as most important (*“Better legislation, better enforcement and consumers’ information”*, *“Strict and ambitious legislation, instead of placing the burden on consumers ...”*).

But also, the relevance of common standards and reliable consumer information was mentioned. *“A mix between regulatory (ecodesign ...) and informative indicators (energy label) would be the best to achieve a proper competition among providers and communication towards consumers.”*

It was also stressed that the reduction of the environmental impacts of electronic communications services is very important because of its increasing use. One respondent answered: *“The current trend of digital overconsumption in the world is unsustainable in terms of the energy and materials it requires,’ writes The Shift Project in its latest report. Against this background, we must also ask ourselves for which important applications do we need ICT and for which unsustainable applications that are not of outstanding importance for our society there is no infrastructure funded with taxpayers’ money (or only at prices that take all external costs into account).”*

[Summary and conclusions from the consumer organisations survey](#)

The survey among consumer organisations aimed to find out whether environment-related consumer information on electronic services is at all effective and how it should be designed in order to better achieve the goal of environmental protection.

The answers of the consumer organisations are ambivalent. In principle, they expect that more information on electronic communication services could reduce energy consumption (see Figure 27). However, it is doubted that the energy efficiency of services is an essential decision criterion for consumers (Figure 28). To set up consumer information, easy-to-understand information is preferred: best at the level of the specific service (Figure 29) and using energy consumption per year and subscriber (Figure 30). In addition to the pure numbers, the graphical representation with a colour code, comparable to the energy efficiency label, is welcomed (Figure 32). The main risk of such consumer information is that companies present themselves as environmentally friendly without really being so (“greenwashing”) (Figure 34). In order to reduce the energy consumption of electronic communication networks, however, the priority of politics should, in the opinion of the consumer organisations, be on obligatory measures, such as Ecodesign, and not on information measures (Figure 35). Of the pure information measures, an energy label is mentioned as the most promising (also Figure 35).

The survey results allow some preliminary conclusions for the present study. One is that simply offering information is not enough to transform the market. Rather, mandatory measures must steer the market in an environmentally friendly direction. The second is that information measures could then serve to make the successes in reducing energy consumption and increasing efficiency visible. A combination of Ecodesign and energy efficiency labelling therefore seems to be a target-oriented way to introduce more energy efficiency in electronic networks. Indicators used for ecodesign requirements usually have a product-related focus (e.g. energy consumption of a product per year for a standard usage cycle). For electronic communications services, a suitable reference unit should therefore also be found that relates the environmental impacts of the product to its use. The unit “energy consumption per year and subscriber” was preferred by consumer organisations and has the

necessary product focus. However, further methodological challenges have to be solved (e.g. definition of a standard usage scenario) before this benchmark can be used.

Task 1.2.5: Criteria for the assessment of the environmental sustainability of new electronic communications networks

Aim of this task

In this task the suitability of potential criteria for environmental sustainability is examined, especially with regard to energy efficiency and greenhouse gas emissions, in order to intervene in the deployment of new networks or their expansions with suitable regulations. If no such criteria exist, suggestions are made as to how this can be achieved. With regard to the applicability of these instruments in practice, they should be effective (ensure the environmental sustainability of the networks that meet these criteria), neutral (objective, proportionate, non-discriminatory and technologically neutral) and efficient (cost and effort for verification, both for network operators and for public authorities).

Principles for the suitability of environmental criteria

The development of suitable indicators and minimum requirements for electronic communications networks is in principle carried out according to the same rules as the development of requirements for eco-labels (EN ISO 14024:2018) and criteria for green procurement. These criteria are also applied ex-ante to a product before it is allowed to be certified with an eco-label or before it is purchased as part of the procurement process.

- Criteria address the significant environmental impacts of a product or service along its life cycle,
- criteria must be effective: the fulfilment of the criteria must offer environmental advantages,
- requirements must be supported by verifiable indicators that confirm the fulfilment of the criterion (e.g. verification of the criterion “energy efficiency” by measuring energy consumption and data transmission on the network component itself)
- for the quantification of the indicators, reference must be made to test specifications that allow independent and reproducible verification (e.g. reference to a standard or specification of a test specification),
- the requirements must be objective so that fair competition is not distorted.

Identification of the environmental hotspots in electronic communication networks

Based on existing studies, it can be deduced in which areas of electronic communication networks the greatest energy consumption and thus greenhouse gas emissions occur. If criteria are applied to assess the environmental impact of new electronic communication networks, these areas must be given special consideration as environmental hotspots.

Energy consumption in the use phase of network equipment

Life cycle assessments (LCAs) have been conducted in the past to determine the environmental impact of electronic communication network equipment. The study from Pino (2017) on core network equipment for mobile telecommunications concludes that

the **use phase clearly dominates** over the other life cycle phases in terms of GHG emissions, with the use phase contributing 91.9 per cent and the manufacturing phase only 8 per cent. Studies by CISCO (2020) also come to very similar conclusions, finding for large chassis based routers that the use phase clearly dominates with 92.7 percent of greenhouse gas emissions. Greenhouse gas emissions in the use phase are predominantly related to the electricity consumption of the network equipment.

One **focus of the environmental criteria** that are to be suitable for reducing greenhouse gas emissions must therefore relate to the **energy consumption of the equipment in the use phase**. This includes both energy-efficient hardware but also software-related efforts such as intelligent energy-saving functions and efficient data routing.

Energy consumption of access networks

Task 1.2.3 presented the results of a study from Gröger and Liu (2021), which examined the energy consumption of a data stream along the various network components from the user to the data centre (Table 34). The energy demand of a uniform data stream of 2.2 Mbps via different fixed network accesses (VDSL and fibre optics) as well as via the mobile network accesses 4G and 5G was examined. The results show that within a electronic communication network connection, the access network has the largest share of energy consumption (74 to 99 percent of the total power). The reason for this uneven distribution is that the network components within the aggregation network and the core network are always well utilised due to the number of customers (data streams) to be served. The components of the access network, on the other hand, are only shared by a few users and must nevertheless be designed for peak load (maximum data flow). Within the energy consumption of electronic communication networks, a further focus can therefore be placed on access networks and less on aggregation or core networks.

Energy consumption of mobile network infrastructure

A study conducted by ITU on greenhouse gas emissions in the information and communication technology sector (ITU-T L-1470 2020) shows that the electricity consumption of communication networks is **dominated by mobile network infrastructure**. This is shown in Figure 23 presented within Task 1.2.3. In 2020, mobile networks accounted for 60% of the electricity consumption of the entire network, while fixed network connections accounted for only 40%. The expected trend is towards more mobile access points, which are expected to consume 65% of the network electricity in 2030.

A manufacturers study (Ericsson 2020) show the latest projection of global mobile networks based on the technology generations. The technologies 2G (GSM/EDGE) and 3G (WCDMA/HSPA) will be slowly phased out in the near future. Of a total of 8.8 billion mobile subscriptions worldwide in 2026 it is expected to be 4 billion 4G (LTE) subscriptions (45%), 3.5 billion 5G subscriptions (40%), and only 1.3 billion of the older standards (15%). For Western Europe the study expects in the year 2026 29% of subscriptions to be 4G and 68% to be 5G technology and the remaining rest only 3% (Ericsson 2020). Therefore, **a particular focus** of the environmental assessment

criteria should be on the **mobile network with the 4G and 5G technology generations**.

Summary of environmental hotspots of electronic communication networks

In summary, the environmental hotspots of electronic communication networks are:

- the **energy consumption in the use phase** of network equipment
- in particular the **energy consumption of access networks**
- and, due to their growing importance, especially the **energy consumption of mobile network infrastructure**.

Criteria for energy-efficient telecommunication network equipment and operation

To develop criteria for energy-efficient telecommunication network equipment and operation several studies and initiatives have been undertaken. The most important results of these studies and initiatives are presented below.

Stobbe and Berwald (2019) conducted a study for the Green Electronics Council and TÜV Rheinland with the aim of developing sustainability criteria for the EPEAT eco-label and the TÜV Green Product Mark for large network equipment (LNE). The study refers to large switches and routers used in companies and communication networks. The authors provide recommendations for the development of sustainability criteria for large network devices for the two eco-labels mentioned above. The criteria have meanwhile been adopted by TÜV Rheinland and Global Electronics Council (2021).

The JRC-Study (Canfora et al. 2020) on Best Environmental Management Practices (BEMP) in the Telecommunications and ICT Services sector describes practices to reduce the environmental impacts when planning or renovating telecommunication networks.

Additionally the EU Code of Conduct on Energy Consumption of Broadband Equipment (Bertoldi and Lejeune 2020) defines voluntary minimum requirements for highly energy-efficient network equipment which are suitable to be adopted as criteria for the assessment of the environmental sustainability of new electronic communications networks.

Criteria for metrics to be applied

Networks should generally be planned taking into account metrics that focus on the energy requirements of the networks and network components. Such metrics should be based, on existing ITU or ETSI standards:

- Network equipment: as shown in Task 1.2.3, Table 36, there are many metrics covering different types of networks equipment which have been defined in ITU-T and ETSI standards. The **Energy efficiency rating (EER)** [Mbit/s/W] based on ITU-T L.1310 “Energy efficiency metrics and measurement methods for telecommunication equipment” is well suited for being used in common for different technologies due to its generic approach. The core task of all network devices is to transmit data. Therefore, all devices, regardless of whether they are access points, distribution switches or line amplifiers, can be measured for both their data volume and their

energy consumption. If the ratio between the amount of data transmitted and the electrical power consumption is calculated, different technologies can be directly compared with each other and the energy requirements of different network nodes can be added together. The EER therefore provides an important parameter for calculating the overall efficiency of networks.

- If the construction of a new base station is planned, the average power consumption of the components used can be assessed according to ETSI ES 202 706-1, where the **average power consumption of the base station** is based on the measured power consumption under static conditions. For this purpose, the manufacturer of network components can carry out measurements for various load conditions under laboratory conditions and publish the results in its data sheets. This enables the network operator's planner to select energy-efficient equipment combinations before they are installed. Calculating the expected energy consumption is even a prerequisite for being able to correctly dimension the energy supply (e.g. uninterruptible power supply) and the air conditioning of basestation equipment rooms.
- For fixed networks, the focus of the metrics can be on the **components of the access network** for the reasons mentioned above. Suitable metrics for this are, for example, ETSI EN 305 200-2-2 V1.2.1 (2018-08) "Access, Terminals, Transmission and Multiplexing (ATTM); Energy management; Operational infrastructures; Global KPIs; Part 2: Specific requirements; Sub-part 2: Fixed broadband access networks".

Criteria for power supply units

Power supply units are used in all areas of the network. They transform the voltage from the power grid into a low voltage that is required by the network components. The voltage conversion is basically subject to losses, which is expressed by an efficiency of the power supply unit. If a power supply unit has a poor efficiency, it not only requires more electrical energy, but also generates more waste heat, which has to be dissipated again by means of an energy-intensive cooling system. The goal must therefore be to use power supply units with the highest possible efficiency (close to 100%). The "80 PLUS" certification system for power supply units can serve as a benchmark here. According to Stobbe and Berwald (2019), the "80 PLUS gold" efficiency level represents very good practice. In the meantime, however, there are also more ambitious efficiency levels "80 PLUS platinum" and "80 PLUS titanium" that can be considered as minimum requirements. The certification system currently awards power supplies in a power range from 100 to 3,000 watts.¹⁴⁷ This already covers the power range for many network components in access networks.

Criteria for management of network sites

In the JRC-Study (Canfora et al. 2020) on Best Environmental Management Practices (BEMP) in the Telecommunications and ICT Services sector, the authors identify various measures that can be implemented during the operation of telecommunications networks to make them more energy efficient. The management practices include the improving of the energy management of existing telecommunications networks, selecting and deploying more energy-

¹⁴⁷ 80 PLUS® Certified Power Supplies and Manufacturers; <https://www.clearexult.com/80plus/>

efficient telecommunications network equipment, installing and upgrading telecommunications networks, reducing the environmental impacts of buildings. The main finding of the study is that networks are technical systems that are constantly evolving. It is therefore not enough to set high standards at a single point in time (e.g. during the initial installation), but the networks and its components must be continuously optimised and further developed. The study cites the example of new equipment being introduced into existing mobile radio base stations. Due to the change in energy consumption, the existing air-conditioning systems must also be adapted to the new demand and optimised accordingly. In addition, it must be weighed up when it is reasonable to replace outdated and inefficient technology with new technology. Environmental and energy management can ensure that existing systems are continuously optimised. Efficiency metrics should support the identification and elimination of inefficiencies in operations.

Criteria for cooling equipment

The ambient temperature and humidity as well as the power consumption of the network devices influence the power consumption of the cooling devices. The most efficient type of cooling is when no cooling is needed at all. Base stations today can be safely operated at temperatures above 45 °C. Locating and limiting the density of equipment within the base station can help minimise the internal temperature. ASHRAE (American Society of Heating, Refrigerating and Air-Conditioning Engineers) has developed a classification system that describes the temperature and humidity levels within which ICT equipment can operate (cited in Bertoldi and Lejeune 2020). A possible environmental criterion for new network equipment is therefore that it must also be able to operate at temperatures that can be reached in the respective installation location without additional air conditioning. If site cooling is required, efficient cooling concepts (e.g. free air cooling, water cooling) should be considered in preference.

The metric "Total network infrastructure energy efficiency definition (NIEE)" based on ITU-T L.1332, which is defined as the ratio between the energy consumption of the ICT load and the total energy consumption of the network, could be used to assess the energy efficiency of the network infrastructure (see Task 1.2.3 and [Annex 8: Task 1.2.3 Standards and measurement methodologies for the monitoring of environmental footprint of electronic communications networks and services](#)).

In addition, thermal management needs to be optimised by ensuring that equipment with different temperature requirements should be physically separated from each other. This is because when different devices with different temperature requirements are installed in a single room, the cooling temperature is set to the most sensitive devices, i.e. to a lower and thus more energy-consuming temperature value.

The refrigerants used in cooling systems still pose a considerable environmental problem due to their high specific greenhouse gas potential. The aim should therefore be to use refrigerants with a low global warming potential and, at best, natural refrigerants (ammonia, propane, butane, CO₂, water). The German eco-label has set requirements for such refrigeration systems within the framework of the Blue Angel, The German Ecolabel (2019) "Energy Efficient Data Centre Operation (DE-UZ 161)".

Criteria for longevity, repair, reuse, recycling and end of life management

In order to describe entire environmentally friendly products, criteria for saving resources and strengthening the circular economy should also be included. These are typically minimum requirements for product durability, repairability and the provision of spare parts and software updates. In addition, environmentally friendly products must be recyclable, i.e. the main material components must be separable and capable of being fed into suitable recycling cycles. Manufacturers of network components should be obliged to take back used components after the use-phase and either refurbish and reuse them or recycle them in an orderly manner.

Criteria to assess the overall efficiency of electronic communication networks

The previous sections have given an overview of:

- how environmental minimum requirements are basically developed;
- where the main environmental impacts of electronic communication networks lie;
- and how the planners and operators of networks can address the individual environmental problems at the level of infrastructure components.

This section will now show how the efficiency of networks can be assessed from a higher-level perspective. The overarching perspective must be taken when assessing which network is more efficient than another. The energy intensity of the networks was described as a metric for this purpose in the existing practices (Task 1.2.3):

- **Energy intensity of the network** [kWh/GByte]
Energy consumption in a period of time per amount of data transmitted in this period.

The energy intensity can be determined at company level by relating the company's total network (e.g. annual) energy consumption to the amount of data transmitted. In practice, however, a network operator often offers different access technologies (e.g. coaxial cable, copper, fibre, mobile) that would not be differentiated by a company-wide assessment of the total energy consumption. In addition, the provider of an access technology (e.g. a mobile radio base station) uses shared network resources of others after the network access (e.g. as a tenant), so the provider is not responsible for all energy consumption itself or does not know these figures.

Therefore, a two-step calculation of the energy intensity of the networks is proposed here.

First, the energy intensity of the access network should be calculated depending on the access technology. The access network starts outside the end-users premise (building or data centre) and ends at the aggregation network switch.

Calculation per access technology:

- **Energy intensity access network** = Energy consumption access network / Data transfer access network

The following metrics form a good basis for determining these key figures:

- ETSI EN 305 200-2-2 V1.2.1 (2018-08) “Access, Terminals, Transmission and Multiplexing (ATTM); Energy management; Operational infrastructures; Global KPIs; Part 2: Specific requirements; Sub-part 2: Fixed broadband access networks”: KPI for task effectiveness, KPI_{TE} [bits/Wh]. This is the ratio between the data volumes (both upstream and downstream data) and KPI_{EC} . This metric is applied for the fixed broadband access networks.
- ETSI EN 305 200-2-3 V1.1.1 (2018-06) “Access, Terminals, Transmission and Multiplexing (ATTM); Energy management; Operational infrastructures; Global KPIs; Part 2: Specific requirements; Sub-part 3: Mobile broadband access networks”: KPI for task effectiveness, KPI_{TE} [bits/Wh]. This is the ratio between the data at base stations and KPI_{EC} . This metric addresses mobile broadband access networks.
- ETSI EN 303 472 V1.1.1 (2018-10) “Energy efficiency measurement methodology and metrics for radio access network (RAN) equipment”: Capacity energy efficiency KPI ($KPI_{EE-capacity}$) [Mbits/Wh]. This is the ratio between data volume of the base stations (BS) and the total energy consumption of the base station site including the support infrastructure.
- ETSI TS 102 706-2 V1.5.1 (2018-11) “Metrics and measurement method for energy efficiency of wireless Access Network Equipment; Part 2: Energy Efficiency - dynamic measurement method”. Base Station Energy Efficiency (BSEP) [bits/Wh]. This is the ratio between the measured data volume in bits for low, medium and busy-hour load level and the total energy consumption of the base station which results from the weighted energy consumption for each traffic level i.e. low, medium and busy-hour traffic. It should be stressed that “TS” stands for Technical Specifications. This TS covers LTE radio access technology.

Secondly, the energy intensity of the remaining network components (aggregation and core network) must be calculated:

- **Energy intensity rest of network** = energy consumption rest of network / Data transfer aggregation network

As metrics that are potentially applicable were identified for this purpose:

- ETSI ES 203 136 V1.2.1 (2017-10) “Measurement methods for energy efficiency of router and switch equipment”: Energy Efficiency Ratio of Equipment (EER) [Gbps/Watt]. This is the ratio between total weighted throughput and the weighted power for different traffic loads (low, medium and high). This metric could be applied for fixed and mobile networks.
- ITU-T L.1332 (01/2018) “Total network infrastructure energy efficiency metrics”: Total network infrastructure energy efficiency definition (NIEE): The ratio between ICT load energy consumption and total energy consumption of the network. This metric assesses the energy efficiency of network infrastructure. It is understood that this metric could be applied either fixed network or mobile network. It should be stressed that another metric “Site energy efficiency (SEE)” defined in ETSI ES 203 228 V1.3.1 (2020-10) (s. next bulletpoint) also assesses the energy efficiency of network infrastructure, however, focusing on mobile network.

- ETSI ES 203 228 V1.3.1 (2020-10) “Assessment of mobile network energy efficiency”: Mobile network (MN) data energy efficiency ($EE_{MN,DV}$) [bit/J]: the ratio between the data volume (DV_{MN}) and the energy consumption (EC_{MN}). This metric is only applied for mobile network. The technologies involved are global system for mobile communication (GSM), universal mobile telecommunications service (UMTS), long term evolution (LTE) and 5G New Radio (NR). The ETSI standard provides also a method to extrapolate the assessment of energy efficiency from sub-network to total networks.

To calculate the energy intensity of the network, both values can then be added together and displayed depending on the access technology:

- **Energy intensity of the network** = Energy intensity access network + Energy intensity rest of network

If a network provider only operates an access network and uses external network resources from the aggregation network onwards, he can ask the respective network provider for the energy intensity of the external resources used and include them in his own calculation. The same applies in the reverse case, if an operator only operates an aggregation or core network and makes it available to others. In this case, the operator must make the specific efficiency data for its network section available to its customers.

The energy intensity of the access network can also be calculated on the basis of a specific site. In addition, it is possible to calculate the energy intensity already in the planning phase of a location based on the planned technical equipment (network components, air conditioning, other technology). For example, if public subsidies are provided to build broadband infrastructures, an energy efficiency competition should always be conducted as well. **Only the most energy-efficient provider should receive public funding.** In order to ensure that these pure planning values were not calculated too favourably in order to manipulate the competition, suitable verification requirements and, if necessary, contractual penalties must also be defined.

So far, such metrics for calculating the energy intensity of networks have only been published in individual cases and usually calculated with different system boundaries (e.g. energy consumption including administrative properties such as offices and shops of the provider). Therefore, the data available so far is too poor to set specific benchmarks as minimum criteria. This will change when the disclosure of such efficiency values becomes mandatory and network operators have to publish such figures when licensing frequencies or using public infrastructures (e.g. shared cable ducts within the public space). In addition to the transparency measures towards consumers (see task 1.2.4), transparency measures towards telecommunications regulators should therefore also be implemented. In the policy options (task 2.1), the two options ECN Energy Register and Code of Conduct on transparency measures for telecommunication services are proposed. This will **create a data basis that can be used to define minimum requirements in the future.** Based on this, it will therefore be possible to define benchmarks that must be met before access to public infrastructure is granted or before building permits are issued.

2.3. Main lessons on indicators and standards for Data Centres and Electronic Communications Services and Networks

After the detailed analyses of the definitions, market practices and metrics currently used for DCs and ECNs, this section aims to summarize and provide an overview of the main lessons that can be derived. In turn it will serve as a basis for elaborating potential policy options, and for analysing the environmental, social and economic impacts. The latter will be done in the next chapter.

With respect to the data centres an important conclusion is that there is an enormous diversity between and within DCs implying that a particular policy option might have a different balance between environmental and economic impacts depending on the precise business model used and structure of the DC. In terms of existing market practices it can be observed that large DCs tend to be more inclined towards circular economy practices than small ones, hence an area for potential policy intervention to promote circularity practices among the small DCs. Potential strategies to encourage the greening of DCs can be envisioned in the areas of improving access to finance, industrial symbiosis and sharing of best practices. Evidently adjustment of existing legislation is a potential option as well, which will be explored in the next chapter. Concerning energy and resource efficiency measures there are already quite a large number of different methods and metrics that focus on data centres and their individual components. For instance the European Data Centre Standard EN 50600-4 key performance indicators (KPIs) series are of particular interest for assessing various environmental characteristics such as the PUE, REF, WUE. However all existing measures have a clear focus on energy related issues. Circular economy metrics and metrics related to the leakage of greenhouse gas emissions are barely covered.

With respect to the ECNs it can be indicated that the environmental sustainability reporting is currently mainly focused on businesses and investors. Thereby, established and cross-sectoral standards such as GRI, GHG protocol, CDP, ISO 14001/50001 are preferred. For the planning of new networks the Code of Conduct for Broadband Equipment is an important guide for purchasing equipment. ECNs have already a sufficiently specific set of metrics to determine energy efficiency and energy consumption and to report them in a standardised form. Energy efficiency can however substantially differ among networks due to their specific technical characteristics (wireless vs fibre cable, old vs new technologies). From the end-users perspective, there are currently no established labels and metrics for communicating the environmental benefits of telecom services and for comparing different providers.

In the subsequent sections, the main lessons are presented in more detail, first for the DCs and then for the ECNs.

2.3.1. Main lessons for Data Centres – definitions, market practices and measures

Definitions

Our research on the various definitions and categorisations of data centres currently in use, reveals a lack of consensus between the various actors involved in the field on what definitions and categorisations to use. This might be testimony to the complex reality behind data centres. In other words, it is hard to define and categorise data centres as a consequence of their many shapes and formats. In further developing and finetuning specific policy options aimed at

greening data centres, one should take into account this finding, namely that there is an enormous diversity both within and between data centres.

Diversity *within* data centres:

Within a data centre **several layers** are present. These layers are: the building (the outer layer), the support infrastructure, the IT-equipment, the applications that run on top of the equipment and the users. Most importantly in the context of this study, energy efficiency and circularity aspects relate to each of these layers. In designing policy measures it should always be clear what layer(s) would be affected by the measure. Furthermore, these layers might be owned or operated by **different organisations**, which in turn might affect who is able and/or responsible to access metrics related to energy efficiency and environmentally relevant data, communicate these, and who bears the costs associated with implementing new measures to improve energy and resource efficiency.

Data centre layer	Owned by:	Operated by:
Building	xxxx	xxxx
Support infrastructure	xxxx	xxxx
IT equipment	xxxx	xxxx
Application layer	xxxx	xxxx

Diversity *between* data centres:

The many constellations of what can be a data centre complicates policy formulation as it can be **challenging to identify what organisations exactly needs to be targeted** within a data centre and due to **potentially diverging impacts** of policy options depending on the type of data centre, especially on how economic impacts compare to environmental impacts.

With respect to the former, other ownership/purpose models of data centres imply other organisations that bear the energy costs and have access to data and metrics:

- *Enterprise data centre:* Owner, operator and (main) user of data centre is the same organisation, bearing all energy cost and having access to all relevant energy efficiency and environmentally relevant data. In terms of total number and total floor size, enterprise data centres constitute the largest group among all data centres (cf. Section 2.1).
- *Co-hosting data centre:* Both the information technology equipment and the support infrastructure of the building are provided by the data centre operator or owner, who bears initially all energy costs, while users pay indirectly, depending on their contracts/tariffs, which are not directly linked to energy consumption and are often flat rates. Energy efficiency and environmentally relevant data is available at the same organisation.
- *Co-location data centre:* The support infrastructure of the data centre (such as power distribution, security and environmental control) is provided as a service by the data centre infrastructure operator, who bears all initial energy costs. Customers pay energy costs to

the data centre infrastructure operator, based on their contract which include actual energy consumption and a possible fee related to the additional energy costs such as cooling systems, UPS and other losses. Energy efficiency and environmentally relevant data is hence spread across different actors.

The multitude of data centres in existence implies policy design or assessment needs to take into account potential diverging impacts of policy measures. A key element in this is how the magnitude of potentially positive environmental impacts/impacts on circularity compare to potentially negative economic or social impacts. This could depend on for example the size of data centre, the type of owner/operator, the redundancy of the data centre and the business function of the data centre. Below, we list some examples:

- *Size*: smaller data centres might individually have a relatively low impact on the environment, combined however, the picture might be very different. Setting specific energy and/or resource efficiency targets for smaller data centres might, however, imply significant investments that are hard to justify from a business perspective. This might in turn imply the need for financial support, rather than other types of support.
 - To identify small data centres, a minimum thresholds should be agreed upon. Our research suggest a minimum size of 6 server racks. More importantly, however, than size, is the technology deployed and its energy/resource efficiency. In order to identify relevant data centres to be targeted for specific policy measures, it would therefore be paramount that related reporting mechanisms are implemented.
- *Type of owner - private versus public data centres and size*: the EURECA project revealed smaller public data centres run on older server equipment inducing a large waste of energy. Given the higher energy waste in smaller public facilities (less than 25 racks) they should be one of the target groups of policy reform aimed at greening data centres, e.g. by augmenting/adapting the EU GPP criteria for Data Centres, Server Rooms and Cloud services and/or making some criteria mandatory.
- Data centres that offer a higher degree of availability (i.e. higher tier data centres) will typically use more redundant components which implies -ceteris paribus- a higher consumption of energy. This emphasises the fact that there is a potential trade-off between availability and energy consumption. When designing policy it should also be noted that sometimes the levels of availability of data centres are too high compared to what end-users really need. Another important factor is the occupation of the data centre. High tier data centres that run for example two independent distribution systems but only have a couple of smaller users, will use too much energy to keep the support infrastructure running compared to what it is used for leading to high PUE values.
- *Business supporting versus business critical data centres*: when a data centre is business critical, the incentives of the organisation operating it, might be different from those of an organisation that uses the data centre to support its business. Large investments might be more worthwhile from a business perspective in the former group.

Market practices

The analysis of current market practices of data centre operators reveal that large industry stakeholders tend to incorporate circular practices more easily and structurally than small companies. This is mainly due to the financial resources at their disposal. While small players

rather incorporate short term strategies and seek out the most efficient and often cheapest equipment, large players deploy dedicated platforms for improving their organisations circularity efforts in a more long term view.¹⁴⁸ As such one could perceive this as a market failure that warrants policy intervention in order to consider both small and big companies at par when it comes to circularity.

Industry needs and trends

Based on industry reports and the stakeholder consultation carried out for the first part of the present interim report, the industry is in need of further standardisation and a common understanding on how circularity can be implemented by IT providers. IT providers are experiencing a surge in client demand for sustainable and circular practices which have the potential to influence future market trends.

Investors seek out data centres as investments due to their increasing demand and new mid-sized data centres being constructed. Undoubtedly the expected growth of cloud and ICT applications makes investing in DCs an interesting opportunity. An advertised circular practice of data centres is the industrial symbiosis approach whereby data centres are being integrated into local energy grids, reusing e.g. waste heat of the buildings and neighbouring factories. In order for potential synergies to occur, the integration of existing and new data centre buildings into the local energy infrastructure is an important consideration for circularity.

The development and production of smaller and more performing components can be perceived as another industry trend. Rather than dealing with the end of life phase circularity is in this case improved through design from the beginning – higher energy and resource efficiency, lower environmental footprints (*ceteris paribus*). This trend feeds another one which is the emergence of edge computing. While one would be tempted to assume that due to concentration and scale economies edge computing would gradually disappear, stakeholders interviewed indicated that it will be a phenomenon that remains if not increases in relative importance in the years to come, especially in relation to IoT, AI, decentralised production systems.

The effective use of existing infrastructure also feeds into the server utilisation rates which find their optimum between 30% and 50%. The current rates in European data centres are below that level and increasing them in the scope of the indicated optimum would also qualify as a circular practice as it prevents the use of superfluous equipment for data centres. However there the borders with security, service back-up and required functionality need to be clearly guarded.

Potential strategies for greening: industrial symbiosis, improving access to finance, sharing best practices

Overall and wherever possible, opportunities for establishing industrial symbioses could be considered such as connecting data centres to local energy grids or even to on-site manufacturing of equipment through additive manufacturing, reducing the burden of transport

¹⁴⁸ Bashroush, R., (2020), Lawrence, A. Beyond PUE: Tackling IT's wasted terawatts, Uptime Institute, p. 18

and material waste in manufacturing, although the latter may only be applicable for certain components.

The discrepancy in financial means between small and large operators points to the potential for improving the financing and investment framework for smaller operators and network providers to implement circular practices in their buildings and networks. Financial incentives are also the most sought after type of measure indicated in our survey to data centre operators and national associations. Key questions to cover in designing such incentives would be the eligibility criteria, which would relate to size and key elements of how the data centres are defined which links of the definition aspects of the present study.

An additional crucial aspect for data centre operators to be able to integrate circularity in their strategies is that of appropriate legislation. As will be illustrated below, it could be relevant to adapt existing legislation to the fast pace of evolving technologies allowing room for adaptation. In conjunction with adapting existing legislation, a particular attention should be given to the specific requirements of data centre operators. Attention should be given to striking a balance between DC specific regulatory obligations and additional requirements in existing or new cross-sector legislation in order not to administratively overburden data centre operators and hinder market entrance or the the capacity to satisfy the requirements.

Sharing and identifying best practice examples of data centres that successfully integrated circular practices, e.g. based on our findings in the first part of the study, could be useful to provide data centres of various sizes further guidance on potential actions. This could take the form of a platform or a live database for data centre operators to consult and obtain relevant information. Jointly, information on partnering up with certified electronics recycling companies for data centre operators could be relevant. Methods for measuring energy and resource efficiency.

Methods for measuring energy and resource efficiency

The research into methods for measuring the energy and resource efficiency of data centres (task 1.1.3) has shown that there are already a large number of different methods and metrics that focus on data centres and their individual components. Particularly useful are the metrics from the European Data Centre Standard EN 50600-4 key performance indicators (KPIs) series, some of them still under development, which very systematically describe the different environmental characteristics of data centres and support them with measurement methods:

- EN 50600-4-1: KPIs - Overview and general requirements
- EN 50600-4-2: KPIs - Power Usage Effectiveness (PUE)
- EN 50600-4-3: KPIs - Renewable Energy Factor (REF)
- EN 50600-4-4: KPIs - IT Equipment Energy Efficiency for Servers (ITEESV)
- EN 50600-4-5: KPIs - IT Equipment Energy Utilisation for Servers (ITEUSV)
- EN 50600-4-6: KPIs - Energy Reuse Factor (ERF)
- EN 50600-4-7: KPIs - Cooling Efficiency Ratio (CER)
- EN 50600-4-8: KPIs - Carbon Usage Effectiveness (CUE)
- EN 50600-4-9: KPIs - Water Usage Effectiveness (WUE)

As a metric within the European Data Centre Standard that may be suitable for comparing the efficiency of different data centres with each other and not just their sub-sectors is currently under development:

- EN 50600-5-1: Data Centre Maturity Model (DCMM)

The key performance indicators developed from the series of the European Data Centre Standard are suitable as a harmonised methodology for measuring energy and resource efficiency of data centres, because they meet the following requirements:

- Goal-oriented: the indicators should describe a clear goal, i.e. resource efficiency and energy efficiency.
- Measurable: the indicators to be proposed should be measurable with justifiable efforts
- Usability: the indicators to be proposed should be pragmatic so that they can easily be adopted by the DCs.
- Optimizable: the indicators to be proposed enable the DCs operators to identify the improvement of the measurement in order to improve their environmental performance
- Comparability: the indicators should be standardized to such an extent that it is possible to compare different data centres.

The existing metrics have a clear **focus on energy-related issues**.

In contrast, issues related to material use, resource efficiency and e-waste generation (together: **contribution to the circular economy**) are still **insufficiently covered by the metrics**. With regard to **climate protection**, leakage quantities of **refrigerants** from cooling systems and the associated greenhouse gas emissions are still insufficiently recorded.

2.3.2. Main lessons for Electronic Communications Services and Networks – reporting, assessing, and measuring environmental sustainability

Task 1.2 of this report investigated which indicators exist to measure and report the energy efficiency and environmental impacts of telecommunications networks. The indicators are used by companies in practice both for their reporting (Task 1.2.1) and for the planning and operation of energy-efficient networks (Task 1.2.2). As measurement methods and standards (Task 1.2.3), there are a large number of technical documents that support the companies. It was examined whether the existing reporting methods are suitable for reaching consumers (Task 1.2.4). It was also shown which indicators and minimum requirements are suitable for predicting the efficiency and environmental impact of networks even before they are built (Task 1.2.5). The most important findings from these investigations are summarised below.

1. Reporting: For reporting, established and cross-sectoral standards are preferred (GRI, GHG protocol, CDP, ISO 14001/50001). The target groups for reporting are professionals and investors. Consumer communication is only secondary, and when it does take place, it tends to be at a general level and highlights the positive effects of the digital transformation.
2. Assessment and Planning: For the planning of new networks and the expansion of existing ones, the voluntary Code of Conduct for Broadband Equipment is an important orientation for the energy efficiency of network equipment. It is used by most ECNs to set minimum requirements when purchasing new equipment. In addition, enterprises

specify requirements for the service life and support time when purchasing, which contributes to resource conservation.

3. Standards: There are a variety of methods and standards for determining the energy consumption and efficiency of network equipment. The most important of these are defined by the standards organisations ITU and ETSI. The ECNs thus have a sufficiently differentiated toolbox of methods to make use of and to report in a standardised form. Unfortunately we do hardly find examples actually used in practice at least in the publications which the network operators use to communicate to their end-users.
4. Consumer perspective: There are no established labels and metrics for communicating the environmental benefits of telecom services and comparing different providers yet. In the context of this project, proposals were developed on how information on telecommunication services could look like, based on the energy efficiency labelling.
5. Energy-efficient networks: The energy efficiency of different electronic communication networks differs. This is particularly due to technical reasons. Mobile networks require more energy than wired networks. Newer technologies are more efficient than older ones. Nevertheless, there are specific criteria that can be taken into account (regardless of the technology) when planning new networks that will lead to inefficiencies being reduced and networks becoming more sustainable overall.

3. Final Results Part 2 – Policy Options

3.1. Goal and operationalisation

3.1.1. Goal

Given the analysis of definitions of data centres (DCs) (results of Task 1.1.1), the recommended indicators and methods (results of Task 1.1.3), and the identified pathways to increase circularity and energy efficiency (results of Tasks 1.1.2), as well as the findings on the indicators and standards for electronic communications services and networks (ECNs) (results of Task 1.2), the main objective in part 2 of this study is to assess and compare the expected environmental, social and economic impacts of i) potential policy measures and mechanisms for greening data centres and ii) potential policy options for an EU-wide transparency measure on the environmental footprint of ECNs focussing on energy consumption and GHG emissions. The ultimate goal is to find measures and mechanisms that are suitable to reach the general objective of improving energy and resource efficiency while avoiding negative economic and social impacts.

Specifically with respect to the ECNs the study objective handled in this chapter is to propose policy options that could be included in a transparency mechanism on the environmental footprint of ECNs toward end-users. This would enable them to choose electronic communications providers on the basis of information on environmental friendly options. This chapter will also assess the potential impact of voluntary and mandatory transparency mechanisms on the environmental footprint of ECNs and relevant stakeholders.

The following section will highlight the operationalisation. The next sections will present the results and findings for DCs (Task 2.1.1.) and for ECNs (Task 2.2.1.).

3.1.2. Operationalisation: a systematic funnel approach based on intervention logic with focus on the impacts

In essence the methodology follows a **funnel approach** starting from the insights and results of the previous chapter and zooming into more detail for the most promising and effective measures in terms of impact. An intermediate version of the measures for DCs has been discussed at an online stakeholders workshop June 4th, 2021. Certain measures were welcomed and unilaterally validated others were qualified. The Final Report incorporates the workshop input as to obtain a more nuanced, mature, yet independent result.

For the DCs the steps of the funnel approach are presented in Figure 36. The steps are the following:

1. **Initial assessment and overview of existing policy measures and options:** a broad brush assessment and short presentation of existing policy measures that have been identified indicating whether the objective of the encompassing directive, regulation, use of targets, etc. is or could be in line with the general objective of increasing the energy efficiency and/or circular economy performance of data centres. This step ensures only the most relevant policy measures are included for further analysis.

2. Comparative analysis of the **intervention logic** of existing policy measures: an concise overview is made of the existing policy measures' intervention logic in order to better identify and select the most appropriate policy measures.
3. **Potential policy options to improve the climate and environmental performance of DCs and cloud computing**: some of the proposed measures in the Terms of Reference are straightforward in their operationalisation and can immediately be used as a starting point for an impact assessment, while others need further elaboration. Based on the work in Part 1 of the study we also introduce new potential policy measures.
4. **Ranking of the policy options and analysis of the main impacts**: the assessment results of the previous steps allows to indicate the most pertinent existing policy measures and elaborate potential options for change in view of reaching better energy efficiency and circularity practices, as well as sustainability transparency criteria for ECNs.

Given the slightly different objective for the ECNs, a similar approach is followed yet with more emphasis on policy options for transparency measures that could contribute to making ECNs more energy efficient and more climate neutral.

Figure 36: Funnel approach for identifying and analysing policy measures and options

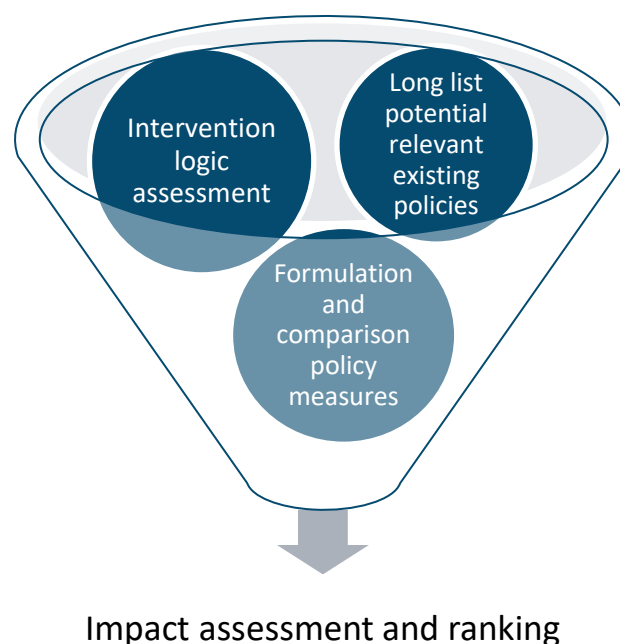

Source: IDEA Consult

To assess and compare the policy options, the different elements of the intervention logic have been analysed using the results from chapter 2 - based on independent desk research, interviews with stakeholders and most notably the stakeholder surveys with DC and ECN operators as well as with consumer organisations. For the policy analysis a step-wise

approach in line with the Better Regulation Guidelines has been used in order to provide a valuable basis for further impact assessment work by the Commission.

The next sections focus on the formulation and comparison of the policy measures that were identified to foster the greening of DCs and to make the ECNs more energy efficient and climate neutral.

3.2. Task 2.1.1. Policy options for Data Centres and Cloud Computing

3.2.1. Description of potential policy options

We identified a set of 12 potential policy measures that may foster the greening of DCs. A visual overview is presented in Figure 37. One can distinguish two dimensions: policy strategy and the nature of the impact. In terms of policy strategy one can distinguish between 1) adjusting existing policy measures making them more fit for purpose for the data centres, and 2) introducing entirely new policy measures. The nature of the impact can be direct – with policy measures specifically focussing on data centres, and indirect - with measures that cover a wider set of economic activities yet which also apply to data centres.¹⁴⁹ The policy measures presented in this study focus particularly on the ones with a direct impact on greening DCs while also exploring how the the policy measures with an indirect impact relate to DCs.

¹⁴⁹ For proper interpretation it has to be indicated that the selected long-list of existing policy measures is not an exhaustive list of Directives and Regulations that apply to DCs. Based on our analysis and insights these are the most relevant ones for greening DCs.

Figure 37: Conceptualisation of a DC and related policies with direct and indirect impacts

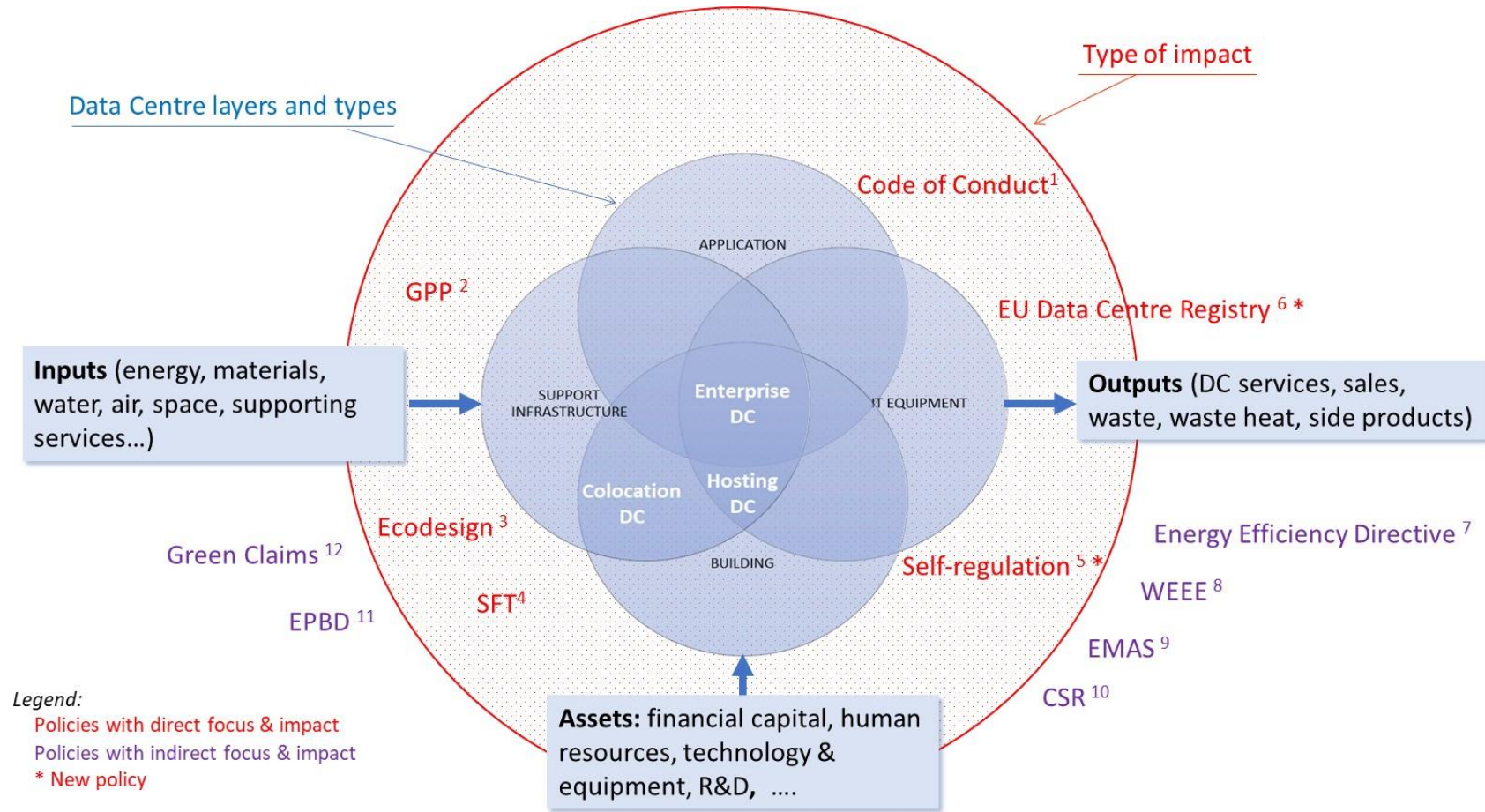

Source: IDEA Consult

Notes:

- | | |
|---|---|
| 1. EU Code of Conduct for Data Centre Energy Efficiency | 7. Energy Efficiency Directive |
| 2. Green Public Procurement | 8. Waste from Electrical and Electronic Equipment |
| 3. Ecodesign Regulation on servers and data storage products (currently under review) | 9. Eco-Management and Audit Scheme |
| 4. Sustainable Finance Taxonomy | 10. Corporate Sustainability Reporting |
| 5. Self-Regulation initiative – <i>new policy</i> | 11. Energy Performance of Buildings Directive |
| 6. European Data Centre Registry – <i>new policy</i> | 12. Environmental Performance of Products and Businesses Initiative – substantiating claims |

We identified six policy measures focusing explicitly on DCs, either on DCs alone as in the CoC, Self-Regulation and EU Data Centre Registry or explicitly referring to DCs as part of a policy focused on the wider value chain, such as the GPP, ecodesign and SFT.

A further set of six policies can be identified that do pertain to DCs, yet are not particularly focused on them and as such exert a rather indirect impact on DCs in the sense that these measures are targeted at a wider set of companies and sectors, which also relate to DCs. This section discusses the main environmental, social and economic impacts that can be expected from the proposed policy measures on the basis of independent research and insights. Each measure is described with its own policy context and policy intervention logic. For the measures that have a direct impact on DCs we separately document the insights, appreciation and remarks of the stakeholders as discussed and obtained during the workshop June 4th, 2021 and in the wake of it.

In the first instance each measure is taken in isolation. Yet where possible, cross-references and aspects of coherence and consistency with other measures are highlighted. We focus on the measures with a direct impact on DCs first before providing a summary of the policies with indirect impact, which reach beyond data centres and have further ecological and social qualities to them.

Policy options with a direct impact

The EU Code of Conduct on Data Centre Energy Efficiency (CoC)

Context

The European Commission, JRC-led EU Code of Conduct on Data Centre Energy Efficiency was established in 2008 as a response to the lack of EU regulation or industry initiatives to address energy efficiency. The CoC is in essence a voluntary commitment of companies to monitor their energy consumption and to achieve reduced energy consumption in a cost-effective manner by the adoption of best practices in a defined timescale¹⁵⁰. The CoC is primarily addressed to data centre owners and operators that can become participant in the CoC, and secondly to the supply chain and service providers which may become endorsers¹⁵¹. The obligation to monitor energy consumption is directed at participants. Endorsers and participants have different sets of best practices. Moreover, the CoC provides a platform for European stakeholders. This means participants and endorsers can proactively bring their practices and ideas to the table, discuss them and agree upon them.

Participation in the Code of Conduct and energy efficiency

At the time of the study there were 145 companies registered on the website as participant, including well-known companies such as Facebook Ireland LTD, Google Data Centres,

¹⁵⁰ See e.g. Bertoldi, P., Avgerinou, M., Castellazzi, L. (2017) Trends in data centre energy consumption under the European Code of Conduct for Data Centre Energy Efficiency, EUR 28874 EN, Publications Office of the European Union, Luxembourg, 2017, ISBN 978-92-79-76445-5, doi:10.2760/358256, JRC108354

¹⁵¹ Endorsers could include vendors and manufacturers, consultants and engineering firms, utilities, customers of data centre services, industry associations and standards bodies (EU Code of Conduct on Data Centre Energy Efficiency. Endorser Guidelines and Registration Form. Version 3.1.0)

Capgemini and IBM Europe, representing a total of 326 data centres, and 261 endorsers¹⁵². A study conducted by JRC¹⁵³ shows that among CoC participants, the PUE declined year after year which indicates the potential effectiveness of such a voluntary initiative. The average PUE value reported was 1.64 in 2016. To determine the effectiveness of participation to the CoC one would, however, need to compare the PUE performance of participants to a group of companies that are similar but didn't participate in the CoC (i.e. a control group). **Therefore we recommend to assess the possibility to perform more rigorous statistical analysis that includes the performance of a control group to determine whether participation yields a better PUE performance over time** (e.g. in a counterfactual analysis). Furthermore, to the best of our knowledge, the latest reported average PUE value of participants dates back to 2016. **To increase transparency on progress made and potentially a competitive market drive, this exercise (i.e. reporting at least the average PUE) could be performed more regularly (for example annually) and be made publicly available and easily accessible.**

Defining data centres in the Code of Conduct

The CoC takes into account the complexity of the data centre market not only by making the distinction between participants and endorsers, but also by considering various sizes of data centres, existing and new data centres, various participant types, several areas of responsibility, and multiple types of best practices. The general definition the CoC applies to describe data centres is “...all buildings, facilities and rooms which contain enterprise servers, server communication equipment, cooling equipment and power equipment, and provide some form of data service (e.g. large scale mission critical facilities all the way down to small server rooms located in office buildings)”¹⁵⁴. **As the CoC is a well-known instrument used by many organisations involved in the data centre market, it could be used as an instrument to propagate a clear definition of what exactly constitutes a data centre. It would be recommended to further align this definition with the one that will be used in EN50600 to avoid further confusion.** Proposed changes to the definition used in EN50600 are presented in section 2.1.

With respect to types of participants, the CoC provides five categories: operator, CoLo provider, CoLo customer, Managed Service Provider and Managed Service Provider in CoLo¹⁵⁵. **Although the various categories are well-explained in the CoC, consistent with our findings in section 2.1, we recommend avoiding the use of the term managed**

¹⁵² Own calculations based on publicly available data on the E3P website (<https://e3p.jrc.ec.europa.eu/communities/data-centres-code-conduct>).

¹⁵³ Bertoldi, P., Avgerinou, M., Castellazzi, L. (2017) Trends in data centre energy consumption under the European Code of Conduct for Data Centre Energy Efficiency, EUR 28874 EN, Publications Office of the European Union, Luxembourg, 2017, ISBN 978-92-79-76445-5, doi:10.2760/358256, JRC108354

¹⁵⁴ EU Code of Conduct on Data Centre Energy Efficiency. Participant Guidelines and Registration Form. Version 3.0.0.

¹⁵⁵ CoLo provider: operates the data centre for the primary purpose of selling space, power and cooling capacity to customers who will install and manage IT hardware. CoLo customer: owns and manages IT equipment located in a data centre in which they purchase managed space, power and cooling capacity. Managed Service Provider: owns and manages the data centre space, power, cooling, IT equipment and some level of software for the purpose of delivering IT services to customers. This would include traditional IT outsourcing. Managed Service Provider in Colo: A managed service provider which purchases space, power or cooling in this data centre.

service provider. Furthermore, although various types of participants are defined, the CoC does not define data centre types in the participant or best practices guidelines. Various data centre types are included, however, in the reporting form (excel file): traditional enterprise, on-demand enterprise, telecom, HPC, hosting, internet, hybrid. **Along the same line of reasoning as above, it would be beneficial for reasons of clarity and coordination to further align these categories with the definitions that will be used in EN50600 and add these to the participant or best practice guidelines documents.**

The CoC is in line with the fact that situations arise where organisations do not control the entire data centre. Operators or owners that are not responsible for all aspects of the data centre can still sign as a participant but have to act as an endorser for the practices outside of their own control. The areas of responsibility they consider are very well defined and can be seen as an elaboration of the data centre layers we provided in section 2.1: the physical building, mechanical and electrical plant, data floor, cabinets, IT equipment, operating system/virtualisation, software. In contrast to our data centre layers, the CoC also includes business practices as an area of responsibility, indicating the responsibility to determine and communicate business requirements for the data centre. This includes the importance of systems, reliability, availability and maintainability specifications and data management processes.

Combining the types of participants with the areas of responsibility, the Best Practices Guidelines provide a clear overview of which of the practices apply to participants based on their areas of responsibility. This is in line with our suggested approach in section 2.1 to be clear about whom exactly is targeted in which data centre layer. Furthermore, the best practices are divided into practices for entire data centres (including existing IT, mechanical and electrical equipment), new software, new IT equipment, new building or retrofitting and optional practices.

[Specific options to improve the Code of Conduct](#)

Despite the fact that the CoC is already quite fit for purpose concerning greening DCs, we have identified four ways in which it could be changed in order to foster the further greening of DCs and cloud computing.

The introduction of quantitative energy efficiency goals

The rationale behind the introduction of quantitative energy efficiency goals next to the obligation to monitor and report energy consumption and the implementation of best practices is to increase, at a faster pace, the energy efficiency of data centres.

Several important challenges arise when considering this measure:

- The diversity in data centres and the various levels of responsibility makes a single energy efficiency goal hard to justify. The same goes for minimum efficiency requirements. The absence in the Code of Conduct on Data Centre Energy Efficiency of a minimum efficiency requirement is a consequence of the diversity of data centres and the various levels of responsibility. In the aforementioned JRC-study it is stated that this diversity makes it not possible to set a minimum efficiency requirement for data centres. This is why this Code of Conduct, as opposed to the others (e.g. on Broadband Communication Equipment or

UPS), has its specific format of participants monitoring their energy consumption and adopting a set of established best practices.

- A potential adverse effect of setting quantitative targets is that these could provide, when too ambitious, a disincentive for data centres to participate in the CoC.
- Whenever a quantitative energy efficiency goal is agreed upon, this goal will only be applicable to participants in the CoC, not to all data centres.
- As the CoC is voluntary, the consequences of not reaching targets are limited (in the worst-case losing participant status).

Recommendations:

- Tailoring targets: Rather than focussing on one quantitative target for all data centres, various (main) categories of data centres should have their own targets, ensuring a level playing field in terms of cost and benefits between the data centres. The categories could be determined by, among other things, whether the data centres are already built and the degree of similarity of their environments. A first suggestion would be to categorise the data centres according to the region they reside in. This suggestion is based on the observation that the average PUE of data centres in colder geographical zones (e.g. the Nordic countries) is lower than in warmer geographical zones (e.g. Southern Europe)¹⁵⁶. In general, a more rigorous analysis based on the relation between characteristics of (the environment of) data centres and PUE-values could inspire a first categorisation of data centres with the intention to develop category-specific targets. A practical starting point would be the data acquired by JRC in the framework of the CoC.
- Combining level and trend targets: As an alternative to specific level(s) of (an) energy efficiency target(s), one should also consider the possibility of aiming for trend targets or a combination of level and trend targets (e.g. for PUE values between X and Y, the trend target is Z%, for PUE values between A and B, the trend target is C%).
- Reachable targets for all stakeholders: Setting efficiency targets should be ambitious enough to reach the goal of climate neutrality of data centres without hampering the mission critical function of data centres, all the while being cost-effective. As such it will be important that the determination of specific targets is an inclusive process in which policy makers as well as the industry are well-represented. A particular point of attention will be the inclusion of a sufficient number of small companies who often have less resources available to represent themselves, a point that was brought to our attention during the interviews.

¹⁵⁶ The average PUE among CoC participants was 1.71 in Nordic countries and 2 in Southern European countries in 2016. Source: P. Bertoldi, M. Avgerinou, L. Castellazzi, Trends in data centre energy consumption

Box 8: Workshop feedback on quantitative energy efficiency goals in the CoC

Overall one may state that according to the participants, setting energy efficiency targets for DCs across the EU within the CoC will be challenging and potentially contested for several reasons:

- i. Regional differences in climate;
- ii. Differences in degrees of renewable energy supply and valorisation potential of excess heat in industrial symbiosis applications;
- iii. Differences in business operating models, redundancy levels, etc.

Nonetheless it was indicated that DC activities can be clearly defined and in terms of PUE clear target ranges can be set potentially taking into account the differences in climate, renewable energy access and business models. The overall sentiment was therefore to keep the best practices approach and the voluntary nature of the CoC.

On the basis of the discussion it is clear that a “*one size fits all*” approach will potentially be counter-productive from a policy perspective. The participants did not go so far as to indicate what their strategies would be if the CoC was to include quantitative energy efficiency targets. Yet the concern for having a level playing field in the EU was emphasised, as well as the importance of return on investment. The sheer technical complexity of the matter was perceived as another factor to be taken into account.

It was endorsed that the CoC contributed to the greening of DCs. From this point of view one could propose to introduce a widely accepted quantitative energy efficiency target such as the PUE, in combination with a range that reflects the regional differences across the EU. A classification of data centres could help compare data centres that are within the same classes (access to renewable energy, size, regional climate and waste heat valorisation) and set quantitative targets for each class.

Tier-system label indicating the adoption rate of best practices and mandatory best practices

The introduction of new minimum expected levels of energy savings currently happens by focusing on the application of new activities¹⁵⁷ rather than specific quantitative energy savings targets. Although a value is assigned to each of the practices, these values are not intended to be aggregated to provide an overall ‘operator score’ and for good reasons as this would require, so it is stated, large scale data on the effects of each practice or technology which is not yet available. Also a complex system of scoring representing the combinational increase or reduction of individual practice values within that specific facility is a challenge. Although such a scoring system would be useful in terms of transparency and competitiveness, the process of developing it seems very costly.

¹⁵⁷ Practices to become minimum expected in 2022 and items under consideration are listed in the 2021 Best Practice Guidelines (Version 12.1.0).

The introduction of new expected energy savings activities boils down to making these practices ‘mandatory’ in the sense that participants should implement them within an agreed time period and can lose their participant status when they are not implemented. In practice the image is more nuanced: it is recognised in the CoC that not all operators are able to implement all the minimum expected practices due to physical, financial and other kind of constraints. In these cases, an explanation needs to be provided describing the type of constraint, and if possible, recommending alternative practices as replacements aiming to obtain the same energy savings. This nuance is important and helps explaining the fact that in 2016 only 16 participants implemented all 81 mandatory practices. In Figure 38 an overview is given of the frequency of best practices adopted by data centres in 2016 showing that, among other things, the majority of data centres adopts between 26 and 50 best practices.

Figure 38: Frequency of best practices adopted by data centres participating in the CoC in 2016

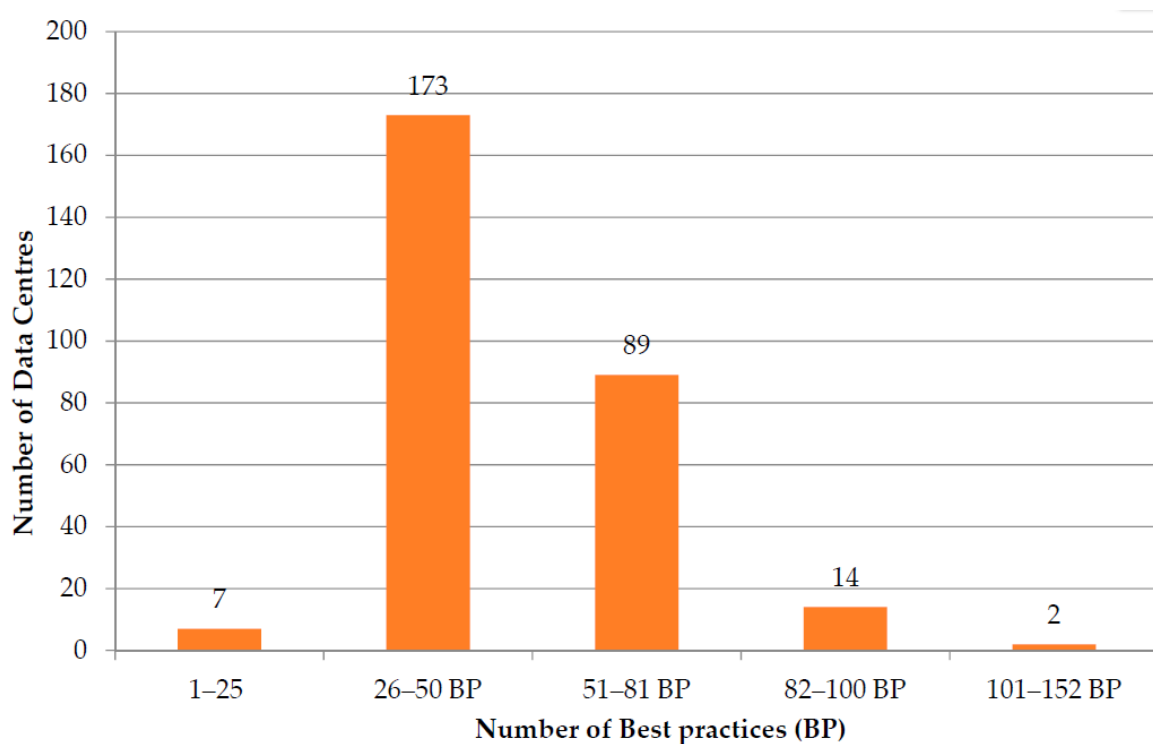

Source: Bertoldi et al. (2017)

This finding suggests that adding new practices as mandatory could potentially only have a limited effect as there is no guarantee the practices will effectively be adopted. This does of course not mean new practices have no use. On the one hand, data centres still have to motivate why these practices can't be adopted and propose solutions and, more general, they are essential in providing knowledge about measures that can be implemented to obtain a higher level of energy efficiency.

Recommendations

- Tier-system labels: Therefore it could be considered to develop a CoC participant label that includes an indication of how many best practices are adopted. This could provide an incentive to data centres to adopt at a faster rate (new) expected and optional best practices. Such a system could be indirectly based on the number of best practices

adopted by working with, as is standard in the field, a tier system of activities improving energy efficiency, a suggestion that was also made by a survey respondent. To be trustworthy, however, a third-party monitoring and certification system should be established (see below).

Box 9: Workshop feedback on introducing a tier-system label indicating the adoption rate of best practices in the CoC

The participants did not perceive a great value added in providing a label for the degree to which best practices are being taken up. This is not to say that the practice doesn't exist already. The UK-based CEEDA does grade the CoC best practices into tier levels (bronze, silver, gold) and includes both mandatory and optional practices. Besides the challenge of assigning appropriate scoring and defining the thresholds, it was argued that a tier-system label would still give no information on the overall efficiency of the DC. The Data Centre Maturity Model, which is still under development, was considered as a potentially more promising approach. Furthermore, as a consequence, in the light of the sector's response, the environmental, economic and social impact that were initially derived and that were presented in the discussion paper have been reassessed (see below).

The establishment of a third-party monitoring obligation for participants

Currently, the number of best practices implemented and the energy consumption is self-reported. As such, the establishment of a third-party monitoring obligation on the implementation of best practices and energy consumption could potentially lead to more accurate data and provide a more trustworthy state of progress on energy efficiency practices. There is some evidence of incorrect self-reporting to be found in the 2017 study led by JRC that clarifies that in three cases (a little more than 1% of the data points) PUE-values smaller than 1 were reported. This is technically impossible as it implies higher IT consumption than the overall energy consumption of the facility. More importantly, data centre operators and owners have an incentive to overstate their real levels of energy savings to obtain (and retain) participant status and the label associated with it which can then be used as a marketing tool as such a label is meant to help potential data centre customers to make informed decisions. A trustworthy label, that could also include an indication of the number of best practices applied (cf. supra), should therefore be based on a certification process that requires third-party monitoring.

Establishing a fully-fledged third-party monitoring system to monitor each participant periodically and make it obligatory would require participants to pay the providers of these services. Especially smaller data centres might be discouraged to participating in the CoC due to a potential imbalance between costs incurred, which are short-term, and potential benefits, which might only incur in the longer term. However, as a side effect, it would create employment in the organisations providing the monitoring services. The implementation of such a system, however, would require, among other things, significant investments in the selection, training and management of third-party monitors.

If the objective of establishing a monitoring obligation is mainly to acquire correct data on energy consumption and savings activities, potentially a cost-efficient solution could be to establish a system of random inspections of participants. This could, given a sufficiently high probability of being inspected, encourage companies to report more carefully.

Box 10: Workshop feedback on third-party monitoring obligation for participants in the CoC

Overall third-party monitoring and certification was perceived as a valuable idea to pursue further, although the financing could be an issue as well as obtaining the right information, especially if it is confidential. The independence of the certifiers would be key as well as a proper protocol as to what exactly to report, for which period (e.g. a year), confidentiality clauses, and ways to report and display aggregated and anonymized information. Since potential solutions can be formulated concerning the financing and confidentiality issues raised, this seems to be a feasible improvement of the CoC.

Tools for increasing participation in the CoC

Various ways can be envisioned to increase participation in the CoC, which even without additional changes as portrayed above would contribute to greening DCs. A number of concrete suggestions can be made, such as:

- The development of a simple online tool instead of the excel reporting form;
- The development of a dedicated website for the CoC that is search engine optimised;
- Proactively contacting (companies with) smaller data centres that potentially lack resources to represent themselves in the CoC;
- The development of a multichannel communication strategy to communicate about the CoC, e.g. on the awards.

Participation can also be increased by extending the scope of the CoC to cover cloud computing. Given our definition of cloud services in section 2.1, the current scope of the Code of Conduct already includes cloud computing, albeit without using the term explicitly. Organisations that offer cloud services could be currently registered as colo operator, colo customer, managed service provider, or managed service provider in colo depending on the services offered. If the term was to be explicitly included in the CoC, it should be defined properly. Furthermore, it could be asked in the reporting form whether organisations see themselves as providers of cloud services given this definition.

As the CoC is a central instrument for greening DCs, the incorporation and reference in other pieces of legislative work may be an effective means to increase participation. Examples are the Inclusion of the requirements in the Ecodesign Regulation on servers and data storage products, or the reference to CoC in the Sustainable Finance Taxonomy.

Box 11: Workshop feedback on tools to increase participation in the CoC

This policy suggestion was very much welcomed. Reaching out to SME DCs fits within current EU policies for digitalisation and SME policies, in order to help to bridge the gap in comparison with large players. As one of the participants suggested this could be linked to the EU Data Centre Registry. Additionally, this could also help in streamlining DCs for investments and financing according to the Sustainable Finance Initiative.

Given the preference for the CoC to remain voluntary, the communication of the advantages, both in terms of reduced environmental impact, as in terms of business and financing potential could be emphasized more strongly. After all, energy efficiency does pay back through cost reductions. This could in turn lead to an increased number of DCs adopting the CoC and ultimately to a minimum critical market size of DCs that apply and adhere to the CoC. Consequently the energy and resource efficiency of the DC sector as a whole would improve.

In this respect the definition of DCs plays an important role and particularly the size classes. Individually large DCs do have an important effect both environmentally as well as economically and socially, yet combined small DCs in an edge computing setting generate undoubtedly equally important effects.

Other suggestions included creating learning tools for improving energy efficiency and present these on the dedicated website or platform. Additionally a dedicated discussion forum where both stakeholders, researchers, policy makers and DC experts can share contributions, figures and information was also perceived as having a strong value added, especially for the small players in the field.

[Overview of potential impacts](#)

Table 37 presents an overview of the expected main environmental, economic and social impacts as well as the cause and effect mechanisms through which the policy measures generate impacts for the four measures of the CoC.

Table 37: Overview of expected main potential impacts for CoC policy options

Policy option and suggested changes		Environmental impact	Economic impact	Social impact
Quantitative energy efficiency goals, regionally differentiated	Impact	Reduced energy intensity of the economy, reduction of GHG emissions	Reduced energy costs, facilitation of introduction and dissemination of new technologies	<ul style="list-style-type: none"> - Better informed businesses and consumers; - Creation of jobs
	Mechanism	Quantitative targets, push participants to improve energy efficiency	Value added creation from energy efficiency investments	Jobs resulting from energy efficiency investments, with emphasis on green skills
Tier-system label indicating adoption rate of best practices	Impact	Potentially reduced energy intensity of the sector, and reduction of GHG emissions, yet probably rather limited effect	<ul style="list-style-type: none"> - Reduced energy costs; - Facilitation of introduction and dissemination of new technologies - Overall limited effects 	<ul style="list-style-type: none"> - Better informed public (B2B, B2C); - Creation of jobs directly and indirectly (upstream of the value chain) - Overall limited effects
	Mechanism	Potentially more incentives to adopt best practices, and/or better knowledge on barriers and possible solutions, yet uptake quite uncertain.	<ul style="list-style-type: none"> - Awareness and adoption of best practices; - Derived demand for R&D&I and knowledge creation - yet uncertain uptake 	<ul style="list-style-type: none"> - Awareness and adoption of best practices; - Derived demand for R&D&I and knowledge creation - Yet uncertain uptake
Third-party monitoring (& certification)	Impact	Reduced energy intensity of the economy, reduction of GHG emissions	<ul style="list-style-type: none"> - Better business and consumer information - Additional costs on businesses 	<ul style="list-style-type: none"> - Better informed public (B2B, B2C, B2G) - Creation of direct jobs

Policy option and suggested changes		Environmental impact	Economic impact	Social impact
	Mechanism	<ul style="list-style-type: none"> - Reduced risk of fraud - Trustworthy label serving as a marketing tool and incentive to invest in energy efficiency 	<ul style="list-style-type: none"> - Collection and dissemination of trustworthy information - Additional costs for third-party monitoring services 	<ul style="list-style-type: none"> - Collection and dissemination of trustworthy information - Job creation related to third-party monitoring services.
Proposed tools to increase participation in the CoC	Impact	Reduced energy intensity of the economy, reduction of GHG emissions	<ul style="list-style-type: none"> - Relevant consumer and business information - Potential improvement of SME competitive position 	Better informed public, business; and public administrations
	Mechanism	Increased participation and implementation of best practices as a result of proposed tools	<ul style="list-style-type: none"> - Development of website, communication strategy - Proactive contacting of small data centres 	Development of website and communication strategy

Source: IDEA Consult

After validation through the stakeholders in the workshop, one may conclude that the DC sector representatives perceived third-party monitoring and tools to increase participation to the CoC as the most feasible and promising policy measure. Introducing quantitative energy efficiency goals was met with a certain restraint and supported only for relatively straightforward measures such as the PUE and when differentiated across regions (climate, access to renewable energy, industrial symbiosis potential) and DC business models. The tier-system label was not perceived as having much effect.

With respect to increasing participation in the CoC, the added value of a dedicated platform for exchanging tools, best practices, information, expert opinions was clearly confirmed as the DC sector is rather complex and fast moving. It would provide more transparency, market insight and information on the state of play with respect to energy and resource efficiency. From that perspective one could advocate the set-up of an observatory. Especially the small

players in the DC market would benefit from this, which in the context of future potential developments such as edge computing is important.

Clearly the definition as to what exactly is a DC becomes important for the further roll out of the policy measures. The definition presented in part 1 of the report – Section 2.3.1. was perceived by the workshop participants as feasible if one were to interpret the various thresholds for the size bands in an optional manner rather than complying at all three criteria together. For instance a DC could be classified as small if either it has a minimum floor space between 100 m² and 1000 m², or 6 to 200 racks, or a power capacity between 50kW and 1MW. Requiring to fulfil all the three criteria at the same time was perceived as not feasible and useful. With respect to the specific thresholds used it was noted that a minimum floor space of 100m² might even be on the large side. The minimum number of six racks and a power capacity of 50 kW was not contested, nor were the thresholds for the large and hyperscale deployments.

Green Public Procurement (GPP)

Context

GPP is primarily focussed on public authorities' purchases and as has been argued before it can therefore provide an important lead market effect generating the crucial minimum demand for highly energy and material efficient solutions. GPP has a wide scope, yet recently quite a number of efforts have been made to increase the performance criteria for ICT related purchases such as monitors, tablets, smartphones, computers, printers, imaging equipment, as well as entire data centres, server rooms and cloud services. Table 38 provides an overview of adjustments to EU GPP criteria in 2020 and early 2021 in the field of data centres.

According to Alfieri et al. (2019) a trend can be expected for public authorities of having DCs on their own property to moving outside their property boundaries towards colocation DCs and services or even to MSPs (JRC 2019 p 89). The segment of cloud computing and edge computing might therefore be attractive. However, just as is the case with private enterprises also government services have areas where data protection and security is paramount (e.g. defence, international relations, medical services) and where in-house 'enterprise type' of data centre services are still the preferred option¹⁵⁸.

¹⁵⁸ Note that in Alfieri et al (2019) the data centres owned by public authorities are also designated as 'Enterprise data centres'. The central differentiating aspect with respect to other types of DCs is that both white-space IT equipment and the grey space auxiliary equipment and building are all in one hand. For a wider discussion of types of DCs we refer to chapter 2, section 2.1. of this report.

Table 38: Recent revisions of EU GPP criteria in the field of the ICT sector

Date of release	Subject	Criteria
June 10th 2021	EU GPP criteria for computers, monitors, tablets and smartphones – translations and accompanying technical report published	<p>Criteria addressing main environmental impacts published in 23 EU languages and provision of the technical background report</p> <p>Details available at:</p> <p>EU criteria - GPP - Environment - European Commission (europa.eu)), and</p> <p>Technical Background Report JRC 2021 GPP Computers Monitors Smartphones</p>
March 11th 2021	EU GPP criteria for computers, monitors, tablets and smartphones	<p>Criteria addressing main environmental impacts:</p> <ul style="list-style-type: none"> • Product lifetime extension • Energy consumption • Harardous substances • End-of-life management • Use of remanufactured and refurbished equipment <p>Details available at EU GPP Criteria for computers, monitors, tablets and smartphones (europa.eu)</p>
December 8th 2020	Translation into 23 EU languages of EU GPP criteria for DCs and imaging equipment, consumables and print services	An overview of criteria in the various languages can be found here: EU criteria - GPP - Environment - European Commission (europa.eu)
July 29th 2020	EU GPP criteria for imaging equipment, consumables, and print services	New environmental criteria are formulated encompassing the entire product life cycle. Details are available from: EU GPP Criteria for cleaning services (europa.eu)

Date of release	Subject	Criteria
June 11 th 2020	Publication of the technical background report on EU GPP criteria for DCs, server rooms and cloud services	See: Dodd, N., Alfieri, F., Maya-Drysdale, L., Viegand, J., Flucker, S., Tozer, R., Whitehead, B., Wu, A., Brocklehurst F.,. Development of the EU Green Public Procurement (GPP) Criteria for Data Centres Server Rooms and Cloud Services , Final Technical Report,, EUR 30251 EN, Publications Office of the European Union , Luxembourg, 2020, ISBN 978-92-76-19447-7, doi:10.2760/964841, JRC118558
March 19 th 2020	EU GPP criteria for DCs, server rooms and cloud services	New environmental criteria encompassing the entire product life cycle covering various procurement routes including buildings, equipment, expansion, consolidation, outsourcing and insourcing, operation and maintenance. Details are available from EU GPP Criteria for cleaning services (europa.eu)

Source: IDEA Consult on the basis of information on the Commission’s website June 2021: [Green Public Procurement - Environment - European Commission \(europa.eu\)](https://ec.europa.eu/euro-iss/procurement/gpp/gpp_criteria_for_cleaning_services_en)

Strong progress has been made towards stricter criteria in the area of energy and material efficiency as well as a strengthening of underlying horizontal methodologies to better assess the costs through Life Cycle Costing. However, the main issue remains that GPP is still a voluntary exercise depending on the public authorities’ willingness to follow the criteria, which could be perceived as one of the sensitive points for reaching sufficient impact.

[Making GPP criteria for DC related purchases mandatory](#)

Therefore, making the EU GPP criteria mandatory for publicly procured DCs, server rooms and cloud services could be a potential option to pursue. To this end, a number of routes can be taken:

1. An increased replacement and depreciation of legacy DCs under the ownership of public authorities and substitution with new, more performing equipment;
2. Continue to work with the existing legacy DCs – potentially stretching the life time, and apply the new, more stringent EU GPP rules only for new purchases;
3. A further move to out- and insourcing of particular DC services thereby requiring to attain to the EU GPP criteria for DCs;
4. A combination of the above.

The above options focus on a rather overall mandatory implementation. It could be possible to focus on making only parts of the EU GPP criteria compulsory, e.g. the core EU GPP

criteria. The following section on the expected impacts focusses on the suggestion of making the EU GPP mandatory in an aggregated manner.

Expected impacts

One of the latest empirical assessments on the uptake of GPP in the EU dates from 2012 – see Renda et al. (2012). Among others it found that 26% of the contracts signed in 2009-2010 by public authorities in the EU included all surveyed EU core GPP criteria. If one makes the assessment less stringent by using the condition of using at least one core EU GPP criterion, the share of contracts was 55%. In other words the 50% GPP target for 2010 was not entirely met. The study also found that an overall positive trend on GPP uptake could be found, yet that it was highly divergent across Member States. Purchasing price was found to be the predominant criterion to evaluate contracts.

A more recent study from Núñez Ferrer (2020) on how the EU's public procurement framework is contributing to achieving the climate and circular economy objectives comes to a similar conclusion, albeit with a different methodology. Referring to the Energy Performance Buildings Directive (2018/844/EU) and the Clean Vehicles Directive (2019/1161/EU) where specific technical specifications were set in view of reducing carbon emissions, the author suggests that on these fronts, substantially more successes were achieved in comparison to the voluntary GPP measures.

In their study for the Commission on energy-efficient cloud computing technologies and policies for an eco-friendly cloud market, Montevecchi et al. (2020) also put GPP forward as a promising policy avenue yet at the same time observed that the uptake and implementation of these criteria at the Member State level was still lagging behind. Particularly for GPP the authors noticed a knowledge gap in GPP competence centres and advisory groups when it came to energy efficient cloud computing. The authors perceive the implementation of the EU criteria at the Member State level as a first essential step. Also (numerous) other studies perceive GPP as a promising policy e.g. Canfora et al (2020), Dodd et al. (2020), Alfieri (2019), yet hitherto impact assessments are to our knowledge at the moment of the study not available¹⁵⁹.

Lundberg et al. (2009) argue that from a welfare theory perspective it is by no means sure that GPP is a cost efficient policy tool and whether it can promote entry into green procurement markets or rather deter it. The authors argue that it is likely more cost efficient to use economic tools such as taxes, subsidies, fees or emission permits. Evidently much will depend on the practical implementation of the GPP and the authors conclude that still much research needs to be done on the subject.

It is in the wake of this knowledge gap that it remains hard to assess what exactly the impact of changing from voluntary to mandatory GPP criteria for DCs would generate. On the first view public authorities would be obliged to adhere to the GPP rules and hence a larger market for green, potentially innovative, solutions would result. Yet as argued by Núñez Ferrer (2020) and Montevecchi et al. (2020) this still depends on the pace of transition of the EU GPP criteria

¹⁵⁹ A similar observation was made by Montevecchi (2020) indicating that “for most of the analysed policy instruments of public and private procurement, no evaluations of their feasibility and effectiveness for energy-efficiency are available”, p. 19.

in national legislation, potentially creating at least temporal discrepancies in the internal EU digital single market. Additionally it is by no means certain how the competitive position of current stakeholders will be affected. Will it be mainly the large established DCs that benefit from the mandatory GPP criteria or can SME DC providers continue to access this important market? What will be the innovative drive for both big and small? Earlier in this study reference was made to the Circular Electronics Partnership mainly consisting of large stakeholders. Given the widely acknowledged policy objective to correct for market imperfections in the field of supporting R&D and SMEs these are not idle considerations. Additionally the impact might also be co-determined by the future developments in the public DC segment. Will the main modus operandi be the public 'enterprise DC' which in turn requires a larger need for specialised procurement knowledge, or will public authorities move towards out- and insourcing, maybe colocation centres or edge computing? The latter modi allow for more selectivity of criteria for specific segments. Nevertheless despite these uncertainties, from a pragmatic, science-based, and political point of view making GPP compulsory could be considered as a further consistent step towards climate neutrality.

Table 39: Overview of expected main impacts and transition mechanisms for mandatory EU GPP criteria

Policy option and suggested changes		Environmental impact	Economic impact	Social impact
<p>Making EU GPP criteria mandatory</p>	<p>Impact</p>	<p>Increase in energy and resource efficiency, and reduction of GHG (ceteris paribus) of public data centres</p>	<ul style="list-style-type: none"> - Increased demand for green technologies and expertise (lead market effect); - Reduced energy and resource costs, upstream value added creation; - Increased public expenditures in the short term 	<ul style="list-style-type: none"> - Higher demand for green (data centre) skills; - Job creation direct and indirect
	<p>Mechanism</p>	<p>Green procurement specifications leading to green solutions provided, including monitoring and follow-up across value chain</p>	<ul style="list-style-type: none"> - Increased demand for green data centre solutions, generating value added creation in supplying industries, valorising R&I - Increased public budget outlays in the short term through price and quantity effects. In the longer term potentially increase in tax revenues 	<p>Writing the procurement specifications, providing the solutions, monitoring, requires green data centre know-how and skills, which may feedback on education and training programmes</p>

Source: IDEA Consult

Box 12: Workshop feedback on mandatory GPP criteria

Although the private DC market segment is considerably larger than the public one, it was deemed feasible and desirable to make GPP rules compulsory. Also from a policy integrity point of view mandatory GPP would be welcomed. The participants pointed to important conditions such as:

- i. An EU level playing field (all Member States need to participate);
- ii. The need for an appropriate accounting method and standards;
- iii. Avoiding introducing biases e.g. to size (due to economies of scale) and
- iv. Giving small DC operators equal access to the public procurement market.

Ecodesign Regulation on servers and data storage products: stricter requirements

Context

The Ecodesign Regulation on servers and data storage products has been referred to earlier in this report in the context of current market practices for improving the circularity of DC hardware and IT equipment (Section 2.1., Task 1.1.2.), the methods for measuring energy and resource efficiency of DCs in view of a harmonised measuring framework (section 2.1. Task 1.1.3.) and in the context of instruments to communicate the environmental benefits to consumers for ECN services (Section 2.2., Tasks 1.2.1.a. and Task 1.2.4.). Clearly this is an important piece of legislation that directly addresses the energy and resource efficiency of products used in the DC value chain.

The Ecodesign Regulation on servers and data storage products from 15 March 2019¹⁶⁰ aims to limit the environmental impact of these products with a set of rules on energy efficiency such as minimum efficiency of the power supply units and minimum server efficiency in active state, maximum consumption in idle state and information on the product operating temperature. In addition, the regulation includes circular economy aspects such as extraction of key-components and of critical raw materials, availability of a functionality for secure data deletion and provision of the latest available version of firmware.

At the time of the study the regulation undergoes an amendment procedure¹⁶¹. On February the 1st 2021 the European Parliament Committee on the Environment, Public Health and Food Safety recommended to raise no objections to the Commission's amendments¹⁶². The

¹⁶⁰ European Commission, (2019), Commission Regulation (EU) 2019/424 of 15 March 2019 laying down ecodesign requirements for servers and data storage products pursuant to Directive 2009/125/EC of the European Parliament and of the Council and amending Commission Regulation (EU) no 617/2013, available from [EUR-Lex - 32019R0424 - EN - EUR-Lex \(europa.eu\)](#)

¹⁶¹ European Commission (2020) Draft Ecodesign Amendment, available from [EC 2020 draft ecodesign amendment EN](#)

¹⁶² European Parliament (2021) Recommendation for a decision B9-0107/2021 available from [RECOMMENDATION FOR A DECISION to raise no objections to the draft Commission regulation amending Regulations \(EU\) 2019/424, \(EU\) 2019/1781, \(EU\) 2019/2019, \(EU\) 2019/2020, \(EU\) 2019/2021, \(EU\) 2019/2022, \(EU\) 2019/2023 and \(EU\) 2019/2024 with regard to ecodesign requirements for servers and data storage products, electric motors and variable speed drives, refrigerating appliances, light sources and separate control gears, electronic displays, household dishwashers,](#)

amendment defines a standard to measure active and idle state power in a standard manner, namely ETSI EN 303 470¹⁶³. Yet there is no discussion on stricter requirements or thresholds. Hence the policy measure that we propose is to go a step further and introduce stricter requirements for idle state power allowances and active state efficiency of servers and introduce minimum thresholds on operation condition classes (allowed ranges for temperature and humidity) for servers and storage products. Note however that the current Ecodesign Regulation already includes an information requirement on the allowable range of temperatures.

Expected impacts

Table 40 provides an overview of the main impacts that can be expected from introducing stricter requirements. While the amendment can be considered as a milestone in the further practical implementation of the Ecodesign Regulation on servers and data storage products, in view of climate neutrality by 2050 it might be worth considering minimum requirements once the methodology to measure active and idle state power has been accepted. The findings of Talens Pieró et al. (2020)¹⁶⁴ who analysed the policy making process of applying circular economy principles for the Ecodesign Regulation for servers and data storage products, suggest that this would not be an unsurmountable task. The authors conclude that key conditions for a successful outcome are the inclusion of stakeholders from an early stage onwards, and a debate supported by appropriate metrics.

Practically, the elaboration of stricter requirements would need an ecodesign preparatory study, in which the requirements about idle and active state performance, material-relevant requirements, and the operational conditions are formulated. Consequently even after the adoption of the amendment, a preparatory study would be very useful to move further in the process.

Using more resource and energy efficient products does not automatically lead to an overall increase in efficiency and reduction of the environmental impacts. The processes and business models in which these products are used are equally important. Yet it is fair to argue that products that are more environmentally sustainable are a basic ingredient and even a precondition for reaching an improved energy and resource efficiency of the DC as a whole. In that respect synergies with the CoC can be helpful.

[household washing machines and household washer-dryers and refrigerating appliances with a direct sales function \(europa.eu\)](#)

¹⁶³ ETSI (2019) Final Draft ETSI EN 303 470 V1.1.0. (2019-01) Environmental Engineering (EE); Energy Efficiency measuring methodology and metrics for servers, accessible from: [EN 303 470 - V1.1.0 - Environmental Engineering \(EE\); Energy Efficiency measurement methodology and metrics for servers \(etsi.org\)](#)

¹⁶⁴ Talens Pieró, L., Polverini, D., Ardente, F., Mathieux, F., (2020) Advances towards circular economy policies in the EU: The new Ecodesign regulation of enterprise servers, in: Resources, Conservation & Recycling, vol. 154, available at: [Advances towards circular economy policies in the EU: The new Ecodesign regulation of enterprise servers - ScienceDirect](#)

Table 40: Overview of expected main impacts and transition mechanisms for stricter requirements in the Ecodesign Regulation on servers and data storage products

Policy option and suggested changes		Environmental impact	Economic impact	Social impact
Stricter requirements for idle and active state and introduction of minimum requirements for operation condition classes	Impact	Contributing to reduction of environmental impact	<ul style="list-style-type: none"> - Increased demand for energy and resource efficient data centre products; - Eventually higher investments 	Increase in the amount of jobs (hours) for specialised energy efficient planning, monitoring and services
	Mechanism	The stock of ICT is gradually being replaced by more efficient technology	Value added creation from energy efficiency investments	Increased demand for know-how, skills, related to production, monitoring and reporting

Source: IDEA Consult

Box 13: Workshop feedback on stricter requirements for servers and data storage products in the Ecodesign Regulation

This policy proposal was supported by the participants. Yet it was indicated that one should pay attention to the entire product value chain, the context of the processes in which these more environmentally friendly servers and data storage equipment are used and to an EU-level playing field (EU Single Market). The scope could be broadened to cooling and heat reuse, and more general to products in processes that are energy intensive.

The economic impact highlighted by the participants is in line with the one which was derived independently in the preliminary assessment: increasing the standards might increase the price of components, and may lead (*ceteris paribus*) to higher investments. Yet this may be offset over time by a reduction in energy costs. The participants also pointed to the specific needs of SMEs and the importance of proper planning and preparation of operations in order to obtain efficiency gains for the DC as a whole.

The Sustainable Finance Taxonomy (SFT)

Context

The Sustainable Finance Taxonomy (SFT) or EU Taxonomy for short, is a common classification system of sustainable economic activities using science-based criteria. Legally it is in the form of a delegated act implemented by the Commission based on the EU Taxonomy Regulation 2020/852, which entered into force the 12th of July 2020¹⁶⁵. It is worth indicating that the Taxonomy is a *'binary tool for activities'*, in other words the subject is the activity, which can be included or excluded, and not the company, which may have activities that are both included and excluded¹⁶⁶. The aim is to help to direct more investments towards sustainable projects and activities by using clear criteria and a common language for investors and other financial market participants at large as well as for entrepreneurs and customers. As such the ultimate goal is helping to meet the EU's climate and energy targets for 2030 as well as the objectives of the European Green Deal.

The EU Taxonomy is part of a wider set of policy instruments and is instrumental to the implementation of the Corporate Sustainability Reporting Directive (CSRD) and the Sustainable Finance Disclosure Regulation (SFDR). Within the CSRD, European organisations subject to the Non-Financial Reporting Directive (i.e. large companies with more than 500 employees and listed companies) will be required to disclose information on their activities and to what extent they are environmentally sustainable. The SFT is expected to enhance transparency and thereby also foster investor confidence regarding green investments, counter greenwashing practices, and facilitate (cross-border) sustainable investment by countering market fragmentation. As indicated by the Commission (2021) not all activities that potentially have a strong contribution to reaching the EU environmental goals are yet covered by the SFT Climate Delegated Act. The EU Taxonomy is to be perceived as a *"living document"* that is expected to be updated over time¹⁶⁷.

¹⁶⁵ Regulation (EU) 2020/852 of the European Parliament and of the Council of 18 June 2020 on the establishment of a framework to facilitate sustainable investment, and amending Regulation (EU) 2019/2088, accessible from [EUR-Lex - 32020R0852 - EN - EUR-Lex \(europa.eu\)](https://eur-lex.europa.eu/lexuris/ui/#/document/32020R0852)

¹⁶⁶ European Commission (2021) Commission Staff Working Document, Impact Assessment Report Accompanying the document Commission Delegated Regulation (EU) ... supplementing Regulation (EU) 2020/852 of the European Parliament and of the Council by establishing the technical screening criteria for determining the conditions under which an economic activity qualifies as contributing substantially to climate change mitigation or climate change adaptation and for determining whether that economic activity causes no significant harm to any of the other environmental objectives, Brussels, 04-06-2021, SWD(2021) 152 final, p.3. accessible from: [taxonomy-regulation-delegated-act-2021-2800-impact-assessment_en.pdf \(europa.eu\)](https://eur-lex.europa.eu/lexuris/ui/#/document/52021DC0188)

¹⁶⁷ European Commission (2021) Communication from the Commission to the European Parliament, the Council, the European Economic and Social Committee and the Committee of the Regions: EU Taxonomy, Corporate Sustainability Reporting, Sustainability Preferences and Fiduciary Duties: Directing finance towards the European Green Deal, Brussels, 21-04-2021 COM(2021) 188 final, p. 4, accessible from: [EUR-Lex - 52021DC0188 - EN - EUR-Lex \(europa.eu\)](https://eur-lex.europa.eu/lexuris/ui/#/document/52021DC0188)

The SFT Climate Delegated Act

The SFT Climate Delegated Act focuses on two of the six environmental objectives, namely i) climate change mitigation and ii) climate change adaptation¹⁶⁸. The Act contains a set of specifications particularly focussed on sustainable investments related to DCs:

- Activities qualified as environmentally sustainable are:
 - Practices listed in the CoC;
 - Verified by independent third-party organisations and audited every three years;
 - If the CoC is not applicable, an explanation of the reasons, the alternatives applied and the energy efficiency gains have to be reported;
 - The global warming potential (GWP) of refrigerants used in the data centre cooling system does not exceed the value of 675.
- Activities need to comply with the “do not significantly harm” criteria (DNSH) for climate change adaptation, sustainable use and protection of water and marine resources.
- For material efficiency the activity can be classified as environmentally sustainable if:
 - It complies with the Ecodesign Regulation on servers and data storage products;
 - It complies with the Hazardous substances Directive for electrical and electronic equipment;
 - It contains an adequate and documented waste management plan and complies with the WEEE Directive

Streamlining with Important Projects of Common European Interest

Focusing on the uptake and financing of new and more energy and resource efficient technologies for DCs, one could also envisage aligning the EU Taxonomy with the criteria to select so-called Important Projects of Common European Interest (IPCEIs), as well as with the guidelines on State aid for environmental protection and energy, which are currently both under revision.

In the revision of the eligibility criteria for IPCEIs¹⁶⁹, projects must present an important contribution to the EU’s objectives, for example those stated in the European Green Deal, the new Circular Economy Action Plan, the Digital Strategy, or the EU Industrial Strategy Update. Considering that the Sustainable Finance Taxonomy incorporates all objectives stated in the above-mentioned policy strategies and sets specific criteria for sustainable investments linked to their objectives, we propose aligning the SFT criteria with the eligibility criteria for the

¹⁶⁸ The other four objectives of the EU Taxonomy Regulation as specified in article nine are iii) sustainable use and protection of water and marine resources, iv) the transition to a circular economy, v) pollution prevention and control and vi) the protection and restoration of biodiversity and ecosystems. A second delegated act covering these four objectives is expected in 2022, (European Commission (2021) website EU taxonomy for sustainable activities, accessible from: [EU taxonomy for sustainable activities | European Commission \(europa.eu\)](https://ec.europa.eu/euro-observatory/en/eu-taxonomy-for-sustainable-activities)

¹⁶⁹ European Commission (2021), Criteria for the analysis of the compatibility with the internal market of State aid to promote the execution of important projects of common European interest, available at https://ec.europa.eu/competition/consultations/2021_ipcei/draft_communication_en.pdf

selection of IPCEI projects and hence provide more leverage for financing the greening of DCs.

In the same context it is important that sustainable investments are streamlined with the IPCEI logic, which implies a correction for market failure for very innovative large scale (across Member States), high TRL projects. Therefore the revision of the guidelines on State aid for environmental protection and energy¹⁷⁰ which aims at aligning the State aid guidelines with the European Green Deal as well as regulations such as the SFT would be very instrumental. In the inception impact assessment of this revision, it is considered requiring Member States to identify, and make transparent, the contribution of State aid to environmental protection based on the Taxonomy definitions. This revision will be an added safeguard for State aid directed toward environmental protection, also as such efforts relate to DCs.

Expected impacts of implementing the Climate Delegated Act

The DC focussed specifications in the SFT Climate Delegated Act revolve around the implementation of the CoC, yet at the same time they extend the scope including third-party verification, puts a ceiling on GWP and introduces DNSH criteria for the non-climate objectives. The Taxonomy functions as an integrating practical framework linking the CoC to other environment focussed policies such as the Ecodesign Regulation and the WEEE Directive. Therefore one would expect that the SFT Climate Delegated Act contributes to the greening of DCs. Table 41 provides an overview of the main perceived impacts as independently derived by the study team.

Early June 2021 the European Commission published the impact assessment report for the Delegated Act on climate change mitigation and adaptation under the Taxonomy Regulation (EU) 2020/852. Interesting for this study is the feedback from ICT-stakeholders that was given on the draft version of the Delegated Act as of November 2020 and in the workshops and calls for feedback from the Technical Expert Group on Sustainable Finance (TEG) and on the inception impact assessment. The report indicates that “*With 44 respondents the Information and Communication Technologies (ICT) questions on data processing, hosting and related activities and on data-driven solutions for GHG emissions reductions received the lowest traction among stakeholders*”¹⁷¹. Given the increasing importance of ICT, and data centres in particular, this suggests that there is still a lot of policy potential for creating positive environmental impact and value added. The report indicates that there was no unanimity on the proposed criteria. Suggested changes included extending the boundaries of the activities including edge computing and data centre power equipment, modifications to the DNSH criteria and more clarity on the standards and codes of conduct used by the sector.

¹⁷⁰ European Commission (2020), Inception impact assessment for Revision of the Guidelines on State aid for environmental protection and energy, available at https://ec.europa.eu/info/law/better-regulation/have-your-say/initiatives/12616-State-aid-for-environmental-protection-and-energy-revised-guidelines_en

¹⁷¹ European Commission (2021) Impact Assessment Report Accompanying the document Commission Delegated Regulation (EU) .../... supplementing Regulation (EU) 2020/852 of the European Parliament and of the Council by establishing the technical screening criteria for determining the conditions under which an economic activity qualifies as contributing substantially to climate change mitigation or climate change adaptation and for determining whether that economic activity causes no significant harm to any of the other environmental objectives. Brussels, 4.6.2021, SWD(2021) 152 final p. 67, accessible from: [taxonomy-regulation-delegated-act-2021-2800-impact-assessment_en.pdf](https://eur-lex.europa.eu/eli/reg_del/2021/2800/impact-assessment_en.pdf) (europa.eu)

Table 41: Overview of expected main impacts and transition mechanisms for the application of the SFT Delegated Act

Policy option and suggested changes		Environmental impact	Economic impact	Social impact
Application of the SFT Delegated Act	Impact	Increase in the energy and material efficiency of EU data centres	Creating a financial (single) market and instruments fostering investments in sustainable data centre solutions	<ul style="list-style-type: none"> - Sustainment and increase in green finance jobs and green data centre jobs; - Upstream effects on education and research jobs
	Mechanism	Speeding up the transition towards green data centre equipment, infrastructure and operations	Earmarking sustainable investments with favourable financing conditions	Increased demand for green finance expertise and know-how

Source: IDEA Consult

Box 14: Workshop feedback on the application of the EU Taxonomy and Climate Delegated Act

The workshop participants did not reach unanimous conclusions about this policy measure, except that it was perceived to be an effective means to counter greenwashing. Some participants indicated that the DC sector does not really suffer from a lack of investment and finance, given its expected development in the future and promising ROIs. Some participants even alluded to a potential crowding-out effect draining sustainable finance from sectors where it is more needed. Nevertheless it was also argued that the EU Taxonomy could be helpful in allocating ‘green money’ to be invested in the implementation of new technologies or to support old DCs or small DCs to refresh and refurbish their infrastructure or IT equipment, and hence improve their overall energy and resource efficiency.

Given the perception of the workshop participants that the value added of this measure is rather limited if not uncertain, or only for particular applications such as supporting renewing old DCs and small DCs, and invigorating new technologies, one could argue that the economic effects formulated in our analysis need to be qualified. Nevertheless in light of having mutually consistent policy measures and given the results of the impact assessment report for the Delegated Act, in our view the EU Taxonomy remains a valuable policy measure that can facilitate investments in the refurbishment and introduction of new and greener technologies in DCs, both large and small.

A DC sector self-regulation initiative (new policy measure)

Context

The DC sector self-regulation initiative as such does not exist and is a new suggestion for a policy measure put forward to DC stakeholders in the context of this study. It is inspired by the Climate Neutral Data Center Pact and the suggestion is that the data centre industry would regulate itself with the aim to increase its energy and resource efficiency. This implies identifying and specifying specific measures and target values to be attained over the years and may involve labelling and certification. It would also potentially require agreements with representative business associations and their members. In conjunction with some of the other policy measures put forward earlier (e.g. CoC), this measure would allow data centre operators to share best practices while at the same time maintaining competitiveness and reaching specified targets in line with the European Green Deal.

Expected impacts

The following table presents the expected impacts and required mechanisms for a DC sector self-regulation initiative to be successful.

Table 42: Overview of expected main impacts and transition mechanisms for the application of a DC sector self-regulation initiative

Policy option and suggested changes		Environmental impact	Economic impact	Social impact
Self-regulation initiative	Impact	<ul style="list-style-type: none"> - Greening of EU data centres, increased energy and resource efficiency; - Relative reduction of energy and material intensity 	<ul style="list-style-type: none"> - Increased value added creation in green data centres; - Higher administrative costs 	<ul style="list-style-type: none"> Sustaining and increasing green jobs in the data centre sector and upstream sectors;
	Mechanism	<ul style="list-style-type: none"> Investment, application and reporting of cleantech solutions and practices for data centres 	<ul style="list-style-type: none"> - Data centres incorporate energy and resource efficiency targets in their business models and strategy; - Additional implementation and reporting costs 	<ul style="list-style-type: none"> - Increased demand for green data centre skills and know-how; - Increased derived demand for STEM profiles and education

Source: IDEA Consult

Box 15: Workshop feedback on a DC sector self-regulation initiative

Self-regulation is a voluntary measure which was positively received but with a few remarks on the eventual effects in terms of resource and energy efficiency. From a policy perspective there is a risk that the sector will go on a sub-optimal path taking it longer to implement new technologies for increased energy and resource efficiency. In contrast to this, one could argue that precisely because the measure has a self-regulation nature, the targets and ambitions put forward are feasible and have a wide support across the DC industry.

This initiative could be formulated in combination with EC oversight and a compliance framework that DC stakeholders could fall back on. Therefore, with careful monitoring (as e.g. in the Data Centre Registry) self-regulation might be a valuable policy option fostering the greening of DCs, if executed in cooperation with third-party control.

A European Data Centre Registry (new policy measure)

Context

This policy measure aims to establish a European Data Centre Registry in which EU DCs are requested to register and provide information on a set of key parameters, which could be developed into a benchmarking tool to monitor energy and resource efficiency progress. The Registry would be accompanied by a protocol to increase trust and confidence between the parties. More specifically we envisage the following set-up:

- The European Data Centre Registry would serve to record an **inventory of data centres** within Europe. The following information could be registered for each data centre:
 - Location
 - Services provided
 - Energy consumption
 - Share of renewable energy
 - GHG emissions
 - Circular economy practices
- In order to promote trust and confidence in the Registry, a mutually agreed **protocol** between the organisation that does the central monitoring and the data centre operators could be a way to bridge the two parties.
- The Registry could serve to monitor the aggregate greenhouse gas emissions of European data centres, increase the reliability and security of supply of the digital infrastructure and create transparency for customers and investors to give preference to climate-friendly and resource and energy efficient data centres.

This policy option could potentially function in combination with the self-regulation initiative proposed earlier and can build further on the current efforts that DCs already undertake on the efficiency of their services. However, as indicated earlier in this report, the metrics currently implemented are mainly focussed on energy efficiency, implying that additional work has to be done as to the metrics for circularity and material efficiency. One also has to take into

account that clients and stakeholders might have preferences or interests in different metrics of the DC and that given the wide variety of DCs, the reported indicators might be difficult to compare due to different functions, redundancy levels, and business models.

Expected impacts

The introduction of an inventory where energy consumption and emissions are transparently reported, will allow sustainable procurement decisions, as well as easy comparison between suppliers. This in turn is expected to boost competition and data centres' incentive to differentiate on the basis of environmental performance. Additionally, such Registry will allow monitoring and analysis of evolutions in the DC sector, which could feed into future policy decisions.

Table 43: Overview of expected main impacts and transition mechanisms for the application of a European Data Centre Registry

Policy option and suggested changes		Environmental impact	Economic impact	Social impact
European Data Centre Registry	Impact	<ul style="list-style-type: none"> - Increase in energy and resource efficiency of EU based data centres; - Better view on overall progress made across the EU and by Member States 	<ul style="list-style-type: none"> - Shift in value added creation towards greener data centres; - Increased demand for energy and resource efficient data centre solutions; - Increase in administrative burdens 	Transition towards green data centre skills, in combination to sustaining and creating jobs
	Mechanism	Increased attention to energy and resource efficiency in reporting and in business model set-up and operation	<ul style="list-style-type: none"> - More focus on energy and resource efficiency in data centre business models and value added creation - Increase in registration time, monitoring and reporting 	Increased demand for green data centre skills and know-how related to green technologies and processes

Source: IDEA Consult

Box 16: Workshop feedback on a European Data Centre Registry

The policy option of the EU Data Centre Registry overall was welcomed. The main concerns related to more practical aspects such as business confidentiality, the detail of data to be provided, access to the data centre, the control of its operation and the management of the Registry.

We believe that these concerns can be tackled in a constructive manner, e.g. attributing the management to an (existing) EU agency, setting up protocols with the DC sector, drafting clear instructions with information that can be provided in a feasible manner and the organisation of the registry platform. Evidently this more practical implementation is beyond the scope of the study, and may necessitate a feasibility study about the precise parameters and organisational options.

From our interviews with stakeholders we know that the DC associations are keen to have an overview for monitoring and analysing the evolutions in the DC sector, both from an environmental and economic point of view. This observation is in line with the positive feedback we obtained in the workshop.

Policy options with an indirect impact

In parallel to adaptations of existing policy measures and new policy measures suggested above, some existing policy measures have an indirect impact on the operation of data centres and merit a reflection on how they could be adapted to best facilitate the uptake of circular and energy efficiency practices in the DC industry. In the current section we summarise how these policies affect data centres.

The Energy Efficiency Directive (EED) entails quantitative targets of energy efficiency improvements at the EU level combined with indicative targets at national level, which may result in further increases in targets or requirements on data centres. Normally when the size of this energy intensity reduction exceeds the growth of the economic activities, it results in an absolute reduction of GHG emissions. When higher targets lead to investments in energy efficiency (development and usage of new technologies), it can result in the application of more energy efficient technologies and a decrease in the price of these technologies. Moreover these investments and the development of technologies can generate a boost on the job market.

The EED includes provisions on the adoption of green procurement standards and procedures by public authorities. Concrete steps in this direction could tap into the large potential of the public sector both as a large buyer and as a “leading by example” actor in the promotion of the greener data centres and cloud computing services that are offered for leasing.

Improved monitoring helps to realise the mechanisms and impacts of the increased quantitative targets. Moreover, when clear information is available and disseminated, this can help inform the general public, as well as investors and consumers. Hence, possibly generating more competition between companies in terms of energy efficiency. Monitoring

however should be designed in a way that the benefits exceed any additional costs for companies. Building further on these results one could envisage:

- The obligatory disclosure of environmental performance indicators and environmental audit results.
- Sector specific energy efficiency standards.
- Measures to stimulate the reuse of wasteheat (e.g. make the assessment of the reuse of waste an obligatory part of the planning and permitting process, stimulate to build large data centres on locations where waste heat can be reused).
- Public reporting mechanisms through which large companies and DCs have to disclose standard measures on environmental performance (e.g. based on the environmental footprint methods).

The implementation of the **The Waste from Electrical and Electronic Equipment (WEEE) Directive** includes data and reporting and WEEE calculation tools. Considering its effectiveness, since the introduction of the WEEE Directive, significant changes occurred in the collection and disposal of WEEE. High amounts of WEEE are now collected separately from domestic waste, bringing economic costs but also additional revenues and jobs.¹⁷² However, a substantial part of collected WEEE remains unreported and may be subject to improper treatment, causing environmental issues.

The classification of certain categories of products as business waste under the WEEE Directive would avoid problems of 'dual use' waste, when business equipment very similar to consumer equipment (like IT equipment) enters the household waste flow and its treatment is paid for by producers of household equipment. Therefore the collection of WEEE from data centres should be separated from the collection of household waste by categorising WEEE from data centres as business waste, to be deposited at specialised waste collection points that assure a proper treatment. With respect to DCs this might imply giving further attention to:

- Waste prevention and circular models (design, reuse, remanufacturing, repair of equipment)
- The application of the WEEE directive for materials and electronic equipment from DCs
- The valorisation of waste heat.

The last amendment to the **Eco-Management and Audit Scheme (EMAS)** regulation (EU Commission Regulation EU 2018/2026) dates from January 9th, 2019. This amendment – the EMAS Annex IV Amendment¹⁷³ - includes an update of EMAS's core indicators. The core indicators are defined in the following key environmental areas: energy, material, water, waste, land use with regard to biodiversity, and emissions.

¹⁷² <https://eur-lex.europa.eu/legal-content/EN/TXT/PDF/?uri=CELEX:52008SC2934&from=EN>

¹⁷³ [COMMISSION REGULATION \(EU\) 2018/ 2026 - of 19 December 2018 - amending Annex IV to Regulation \(EC\) No 1221 / 2009 of the European Parliament and of the Council on the voluntary participation by organisations in a Community eco-management and audit scheme \(EMAS\) \(europa.eu\)](#)

The Fitness Check (EC, 2017¹⁷⁴) indicated that more than 70 % of all EMAS organisations surveyed found that they had improved or significantly improved performance on energy efficiency, use of materials, water consumption and waste production. However, the limited uptake is reducing the effectiveness of the instrument¹⁷⁵. Beyond environmental reporting, organisations use EMAS in general to achieve business opportunities and improve business performance including:

- reducing costs;
- reducing risks;
- improving reputation, and
- becoming more innovative and sustainable.

Higher uptake of EMAS by producers and organisations is needed to drive the overall market and achieve significant changes in consumption and production, resulting in significant environmental benefits. Therefore it would be necessary to consider the following steps:

- promote EMAS to improve awareness and market recognition (organisations) as well as recognition in public policy (public authorities);
- provide incentives and relief from other regulatory requirements (compliance and verification cost for individual companies and organisations);
- further align / harmonize with ISO 14001, which is a globally recognised and less demanding environmental management system;
- develop Sectoral Reference Documents for data centres.

The proposal for a **Corporate Sustainability Reporting (CSR) Directive** (April 21, 2021) adjusts the existing requirements of the Non-financial Reporting Directive (NFRD) (Directive 2014/95/EU) on a number of key aspects to improve the state of sustainable investments in the EU, and as such contribute to creating a climate neutral EU by 2050. In particular, the CSR extends the scope of the NFRD to all large companies and listed companies, with the exception of listed micro companies, and thus virtually multiplying the number of companies that are subject to the CSR Directive by a factor of four in comparison to the NFRD. The reported information under the CSRD is more extensive as well as more detailed.

While independent third-party certification was voluntary under the NFRD, it becomes mandatory in the CSR Directive with the integration in the Auditor's Report, the involvement of a key audit partner and the inclusion and application of the EU Sustainable Finance Taxonomy. The companies are expected to report primarily in a digital format (XHTML) and include the information in the Management Report. The Directive is applicable from financial

¹⁷⁴ European Commission (2017) Report from the Commission to the European Parliament and to the Council on the review of implementation of Regulation (EC) No 122/2009 of the European Parliament and of the Council of 25 November 2009 on voluntary participation by organisations in a Community eco-management and audit scheme (EMAS) and the Regulation (EC) No 66/2010 of the parliament and of the Council of 25 November 2009 on the EU Ecolabel, COM(2017) 355 final, [SWD_2017_252_F1_OTHER_STAFF_WORKING_PAPER_EN_V2_P1_875447 \(SWD Exec summary\).pdf \(europa.eu\)](#)

¹⁷⁵ For instance the uptake of EMAS is substantially lower that of the ISO140001 see European Commission (2017)

year 2023 onwards¹⁷⁶. With respect to DCs it is evident that large and or listed DCs will be subject to the CSR Directive as well.

Directive 2010/31/EU of the European Parliament and Council of 19 May 2010 on the **energy performance of buildings (EPBD)** was one of the key pillars in the EU legislative framework to enhance the energy performance of buildings. In that view, the directive has been amended in 2018-2019 as part of the Clean Energy for all Europeans package and is currently under further review as part of the wider European Green Deal and the Renovation Wave strategy. At the time of the study, the Commission published an inception impact assessment, and launched a public consultation followed by a series of workshops with stakeholders on a set of EPBD related topics.

Since buildings are an important part of the DC infrastructure with climate regulation technologies and heat valorisation, the EPBD revision will have its effect on the operation and investment of new and refurbished DC building infrastructure. At the time of the study, the consultation period had just finished. The adoption of the review has been planned for the last quarter of 2021.

The **Environmental Performance of Products and Businesses Initiative on substantiating green claims** was launched by the European Commission in response to the Green Deal ambitions and further elaboration in the 2020 Circular Economy Action Plan. In view of the increasing number of labels, claims and measuring methods to assess and indicate environmental impact, without any base for proper comparison, mutually consistent definitions and methodologies, the urge was felt to bridge this knowledge gap and introduce a single reliable and commonly accepted method to quantify environmental impacts. In turn this undermines the development of a Single Market for green products¹⁷⁷. The Product and Organisational Environmental Footprint methods (PEFs and POFs) adopted in the European Commission Recommendation 2013/179/EU are potentially a good basis for further application, yet they are voluntary in nature and other methods can be used. Hence the resulting market and regulatory imperfections remain until further policy initiatives on substantiating claims are taken. As indicated in section 2.1. Task 1.1.3., the development of targeted measures for greening DCs can be aligned with the substantiating claims initiative.

Table 44 provides an overview of the expected impacts and transition mechanisms for the Energy Efficiency Directive (EED), the Waste from Electrical and Electronic Equipment (WEEE) Directive and the Eco-Management and Audit Scheme (EMAS) regulation. The Corporate Sustainability Reporting (CSR) Directive has been analysed and discussed in relation to the Sustainable Finance Taxonomy.

Undoubtedly, additional policies can be identified that co-determine the energy and resource efficiency of DCs., for instance the (recast) of the Renewable Energy Directive and the Fit for

¹⁷⁶ For more detailed information on the CSR Directive we refer to the Commission's website at [Corporate sustainability reporting | European Commission \(europa.eu\)](#). A schematic comparison between the NFRD and the CSR Directive we refer to KPMG (2021) [Corporate Sustainability Reporting Directive - The CSRD - KPMG Ireland \(home.kpmg\)](#)

¹⁷⁷ European Commission (2021) Single Market for Green Products Initiative, website: [Single Market for Green Products - Environment - European Commission \(europa.eu\)](#)

55 package which was adopted in July 2021. The latter is especially important in view of promoting internal coherence between the various policy instruments.

Table 44: Overview of expected main impacts and transition mechanisms for policy measures that are indirectly related to data centres

Policy option		Environmental impact	Economic impact	Social impact
Increased quantitative energy efficiency goals (EED)	Impact	Reduced energy intensity of the economy, reduction of GHG emissions	- Reduced energy costs, facilitation of introduction of new technologies and dissemination of new technologies - Potentially (temporary) increased costs to set up data centres.	Better informed businesses, creation of jobs,
	Mechanism	More ambitious quantitative targets push participants to further improve energy efficiency	- Resulting from energy efficiency investments - More ambitious targets/requirements for data centres	Resulting from energy efficiency investments and more pressure on data centres to operate energy efficiently
Improved monitoring, common reporting format (EED)	Impact	Reduced energy intensity of the economy as a whole, reduction of GHG emissions	- Additional costs on businesses - Insights in own performance may shed light on opportunities for cost reduction	- Better informed business - Better informed public and customers
	Mechanism	- Increased required accountability of Member States leads to increased requirements for reporting of sectors and individual companies - Increased transparency towards	- Collection and dissemination of clear information (that can be evaluated against the set targets)	- Collection and dissemination of relevant and trustworthy information

Policy option		Environmental impact	Economic impact	Social impact
		customers can increase competition between companies to become more energy efficient		
Stimulating re-use of waste heat (EED)	Impact	Reduced energy intensity (compared to if no re-use is applied).	<ul style="list-style-type: none"> - New possible synergies (incl. incomes coming from heat generation); - Extra costs to set up data centres; - Introduction of new technologies 	<ul style="list-style-type: none"> - Businesses or households can use waste heat; More awareness with the general public; - Job creation and skill development
	Mechanism	More re-use of waste heat, e.g. to heat buildings.	<ul style="list-style-type: none"> - (Large) data centres can be set up in areas where the heat can be used. - Investments in methods to capture and distribute waste heat. 	Jobs and skill development related to re-use of waste heat, e.g. to heat buildings.
Categorise WEEE from data centres as business waste	Impact	<ul style="list-style-type: none"> - Avoidance of environmental issues such as environmental harm caused by the release of harmful materials, or dumping of WEEE in developing countries; - Better recycling of ICT-critical secondary materials 	Additional value added creation from recycling ICT-critical materials	<ul style="list-style-type: none"> - Treatment of WEEE of data centres is paid for by producers of business equipment; - Jobs and skills creation both direct and indirect

Policy option		Environmental impact	Economic impact	Social impact
	Mechanism	WEEE of data centres have to be disposed as business waste at the official collection points that take care of the proper treatment of WEEE	<ul style="list-style-type: none"> - Stronger market position in the sustainable client segment; - Potential cost reductions due to more efficient use and treatment of materials - Potential rebound effects on customer prices, depending on market power 	Specialised skill development
Promote the uptake of EMAS	Impact	<ul style="list-style-type: none"> - Reduction of emission of greenhouse gases - Improved energy efficiency, use of materials, water consumption and waste production - More sustainable consumption and production 	<ul style="list-style-type: none"> - Enhanced transparency about environmental performance of organisations towards public and authorities - Better informed investment and sustainable finance decisions - Companies invest in new production methods, technologies and products that have a lower environmental impact 	<ul style="list-style-type: none"> - Extra compliance and verification cost for companies - Reporting and control by public authorities gives higher credibility and economic incentive to enhance environmental performance - Specialised skill development
	Mechanism	Companies are stimulated to use Sectoral Reference Documents, Best Practice and Benchmarks to reduce their environmental	<ul style="list-style-type: none"> - Companies compile EMAS reporting - Companies are stimulated to introduce new production methods, technologies and 	Companies make their environmental performance publicly available

Policy option	Environmental impact	Economic impact	Social impact
	impact in various ways	products that have a lower environmental impact	

Source: IDEA Consult

3.3. Task 2.2.1. Policy options for transparency measures for Electronic Communications Services and Networks

3.3.1. Description of policy options for ECNs and ECS

The Communication on Europe’s Digital Future (European Commission 2020b) proposes the introduction of transparency measures for telecom operators on their environmental footprint. The following section presents various policy options that could contribute to more transparency among suppliers. By introducing transparency measures, those suppliers who act in a particularly efficient and environmentally conscious manner can distinguish themselves on the market.

The specific aim of this section is to propose different options for transparency measures and to discuss which of these options could be the most promising. The authors of this study are aware that transparency and communication measures would require further research and alone may not be sufficient to achieve the goal of climate neutrality. The authors are also aware that different climatic conditions in which the technical facilities are operated mean that the energy required for additional air conditioning varies and the efficiency is influenced by this. The same applies to widespread networks with low utilisation, for example in rural areas. In order to compare the efficiency of different networks and access technologies with each other, the respective local conditions (e.g. climatic zone, distance between the network levels, reliability of the power supply) must therefore always be taken into account and it must be ensured that the respective technology is actually applicable on a local level.

After analysing existing instruments in Tasks 1.2.1 and 1.2.1a and considering what might be effective from a consumer perspective in task 1.2.4, the following options for policy options were selected by the study:

- **ECN Energy Register:** EU-wide register on energy consumption and greenhouse gas emissions of telecommunications companies
- **Code of Conduct on transparency measures for telecommunication services:** voluntary agreement on common metrics and information requirements to be reported to end-users for fixed internet access and mobile services.
- **Topten product database** with information on particularly energy-efficient telecommunications services

- **Energy efficiency label** for telecommunication services
- **Eco-label** for telecommunication services

The different policy options and their impact principles are described in the sub-sections below.

On the grounds of the study results, there were online presentations given to interested parties from ECN and ECS provider's side and BEREC (Body of European Regulators for Electronic Communication) working group on 25th June and 28th June respectively. The audience was specifically asked to provide feedback on the feasibility of the respective policy options. The participants of the events and also interested parties that could not attend had the chance to provide their feedback in written form. In both events, general acceptance for the proposed policy options and the especially the recommended ranking was high, although it must be stated that only individual opinions of the participants can be reflected here and that no representative survey of the sector took place. The feedback from these events is documented below in a separate box for each option. In addition, the feedback from consumer organisations from the online survey (task 1.2.4) is documented as feedback on the options.

Box 17: General feedback on the proposed metrics

Telecommunication services, such as internet access or mobile telephony services, can be provided with different technologies that are inherently different in efficiency. In addition to the energy consumption figures, it should therefore be indicated which technology is involved. Energy consumption and the associated greenhouse gas emissions also differ depending on the geographical location (climate zone) and the composition of the electricity mix (renewable energies or coal-fired electricity). A comparison of different suppliers is therefore only possible if the same local conditions exist in each case.

Another problem is seen in the fact that energy intensity (energy consumption per amount of data transmitted) is not the only relevant parameter, as there is a baseline consumption by the networks that also occurs when the networks are idle or in standby. Even when no data is being transmitted, the networks consume energy. The key figures should therefore be chosen so that they are related to typical usage patterns and not to theoretical performance values (e.g. maximum data volume). Furthermore, the consumption-related indicators do not take into account that the expansion of the networks is associated with additional environmental effects (construction sites, landscape consumption, manufacturing efforts). The upgrading of existing networks or the use of particularly durable cables is not favoured by such indicators. Overall, the transparency measures should ensure that innovations are not hindered and that sustainable technological options receive benefits.

ECN Energy Register	
Description	An EU-wide central energy register for electronic communication networks could be created, comparable to the EPREL-Database ¹⁷⁸ for energy-labelled products. Companies that offer their telecommunication services in Europe should provide information here (voluntarily or mandatorily) about their key environmental parameters. The register would serve as a central data collection and monitoring of the achievement of the goal of climate neutrality of telecommunication networks. However, the register would be also publicly accessible so that other interested parties (e.g. professional purchasers or investors) can gain insight into the environmental performance of the companies. The data would be aggregated at the company level and can therefore not be assigned to individual services.
Sustainability Indicators	<p>Suitable indicators that could feed into a ECN Energy Register were identified for this purpose:</p> <ul style="list-style-type: none"> • Annual energy consumption of the ECN company [MWh/a] If applicable, further differentiated by energy source (e.g. electrical energy, district or local heating, diesel, petrol, etc.) and geographical allocation of business operations (e.g. per country). • Energy Intensity of the network [kWh/GByte] Expressed by the metric "energy intensity" (energy consumption per amount of data transmitted). • Share of renewable energies [%] If applicable, further differentiated according to type of renewable energy source (electricity from hydropower, wind power, photovoltaics, solar heat, biomass) together with their specific CO₂ emission factors ([kg CO₂-eq./kWh]). • Annual green house gas emissions of the company [tonnes CO₂-eq./a] If applicable, further differentiated by geographical allocation of business operations (e.g. per country)
Mechanism	Disclosure of energy consumption, efficiency and greenhouse gas emissions is intended to trigger competition among companies. It thus becomes more attractive to implement efficiency and climate protection measures. If the reported values show that companies

¹⁷⁸ https://ec.europa.eu/info/energy-climate-change-environment/standards-tools-and-labels/products-labelling-rules-and-requirements/energy-label-and-ecodesign/product-database_en

The difference between EPREL and the proposed ECN Energy Register is that the energy consumption of energy-related products occurs at the customers' side, whereas the energy consumption of ECNs occurs at the providers' side.

ECN Energy Register

	are not making progress, this can be used for further policy measures.
Impact (environmental and economic)	<p>The environmental impact can be observed directly within the registry.</p> <p>This measure may impose additional costs on companies by requiring the collection of new indicators. Already, some companies report their environmental impacts in individual CSR reports. This data could be easily taken over. For the public institutions, there would be additional costs for the establishment of the register and for market control.</p>

Box 18: Feedback on an ECN energy register

[Only individual opinions can be reflected here and no representative survey took place.]

Stakeholders have expressed concerns about a central register due to the high effort required to keep such data up to date, the question of the administrator of such a register (public, private, European, national) and the target group of the information provided (private consumers, regulators or investors).

Some public authorities already have information on network infrastructure (e.g. mobile base stations) and performance of electronic communications services in different locations, e.g. transmitter overview of the Norwegian Communications Authority (finnsenderen.no) or infrastructure atlas of the German Bundesnetzagentur (breitband-monitor.de/infrastrukturatlas). Similar portals could in principle also be used to provide environment-related information on telecommunications services.

The register could be linked to the Sustainable Finance Taxonomy and CSR standards and thus enable comparability of different companies and their environmental reports.

Code of Conduct on transparency measures for telecommunication services

Code of Conduct on transparency measures for telecommunication services	
Description	A Code of Conduct (CoC) would be a voluntary self-commitment by telecommunications providers to monitor certain environmental data in the operation of their networks, to use uniform measurement and calculation standards and to make certain information available to the public. The company publicly declares that it wants to contribute to climate protection and describes with which measures and at what speed it intends to achieve this. This CoC thus would have a different character and visibility than the already existing Code of Conduct for broadband equipment, which sets minimum requirements at the product level. Within the CoC, different ways are defined how the information on energy efficiency and climate impact of networks can be communicated to end users. This could include disseminating environmentally related information to all customers, for example on the telephone bill, reporting on the company website and in the companies' sustainability reports, or providing the necessary data for a voluntary ECN Energy Register at national or European level.
Sustainability Indicators	The sustainability indicators are basically the same as those for the ECN Energy Register, see above.
Mechanism	By participating in the Code of Conduct, the company signals that it is aware of its environmental impacts and intends to reduce them voluntarily through regular monitoring and improvements. This gives the company an advantage in terms of consumer confidence. Those telecommunication products of the company that are particularly environmentally friendly can thus be specifically promoted and their market share increased.
Impact (environmental and economic)	The effect of the CoC would be indirect. With the introduction of a common communication on the environmental impact of telecommunication services, consumer awareness is raised and a market for environmentally sound services is created. The creation of a Code of Conducts initially involves development costs for the industry as a whole. However, these initial investments can also be saved when applied, since individual measurement methods or reporting formats no longer have to be developed, but instead the standardised CoC document can be used.

Box 19: Feedback on a Code of Conduct

[Only individual opinions can be reflected here and no representative survey took place.]

The existing Code of Conduct for broadband equipment is well accepted by network operators and taken into account in their internal planning. However, extending such a CoC to transparency measures is not seen as very promising by some network operator stakeholders. When it comes to voluntary communication of environmental benefits by operators, a Code of Conduct was not seen as necessary from the perspective of some ECN providers.

In the survey of consumer organisations (task 1.2.4) it was assessed that consumers are not very convinced by such purely voluntary statements. It is feared that only positive characteristics of companies are communicated and that this could foster greenwashing.

Topten product database

Topten product database	
Description	Topten product databases list particularly energy-efficient products so that consumers can get a quick overview of the most environmentally friendly products on the market (Topten Act 2018 ¹⁷⁹). Existing Topten product databases, which exist at national level ¹⁸⁰ , could be expanded to include particularly energy-efficient telecommunication services. The services are differentiated by network access technology (e.g. mobile, satellite, VDSL, FTTH, cable). Companies offering such products report them on a voluntary basis using clearly defined minimum criteria and indicators. The Topten product databases are operated independently from companies by private initiatives or consumer protection organisations.
Sustainability Indicators	Two or three of these environmental indicators should be included: <ul style="list-style-type: none"> • Energy intensity of the network [kWh/GByte] • Energy consumption per hour service usage [Wh/h] • Annual carbon footprint per subscriber [kg CO₂-eq./ (a* subscriber)] • Specific carbon footprint of data transmission [g CO₂-eq./GByte] • Share of renewable energies of the network operator in total energy consumption [%]

¹⁷⁹ Topten Act (2018): Click your way to energy savings. TOPTEN ACT 2015-2018. Find out the most efficient products in Europe with a simple click on the Topten websites. Report. Link: <https://storage.topten.eu/source/files/TOPTEN-ACT-Results-Summary.pdf>

¹⁸⁰ Overview on national Topten Websites: <https://www.topten.eu>

Topten product database

	In addition, the respective prices of the service should be indicated so that an economic comparison is also possible: <ul style="list-style-type: none"> • Price per service unit e.g. [€/year]
Mechanism	Topten product databases are a way to promote the market of efficient products and increase consumer awareness. Before signing a service contract with a telecom company, customers can consult the database and select products that are particularly environmentally friendly. It is expected that this would increase competition for climate-friendly products.
Impact (environmental and economic)	By encouraging customers to move to energy-efficient and climate-friendly telecommunication services, the overall energy consumption and greenhouse gas emissions of networks could be reduced. Particularly efficient technologies can thus be introduced to the market more quickly. For the companies, there is an additional financial cost for submitting their data to the database operator. Since participation is voluntary, a company will do so if the economic benefit from the additional advertising outweighs the effort. For their part, the operators of the databases have a financial cost for collecting and updating the data, which is increased by the fact that the provision of data by the companies is purely voluntary.

Box 20: Feedback on a topten product database

[Only individual opinions can be reflected here and no representative survey took place.]

According to the stakeholders taking part in the ECN workshop the high pace of development could make this policy option not very feasible. Besides, the variety and diversity of communication products can be barely manageable and confusing to consumers.

In the consumer organisations survey (task 1.2.4) this option was not proposed. Instead of this an electronic product passport database was part of the options that could be ranked. This option comes in 4th place among the proposed policy options, with only 6 positive feedbacks out of 10.

Energy efficiency –type of label

Energy efficiency -type of label	
Description	<p>A label similar to the energy efficiency label (Regulation (EU) 2017/1369), which already labels many household appliances, could also be considered for telecommunications services. It should be noted that the existing efficiency label is assigned for physical products (goods) and could not be used for services. The label features an easily interpretable energy efficiency scale from A-G, which is additionally coded with colour bars. The most efficient services have a green A bar, the most inefficient a red G bar. ECN operators would have to determine the values of the indicators per product and label their telecommunication services with an energy efficiency label. As there are no physical products to stick the label on, the graphical representation has to be presented on tariff websites and in advertisements or other communication instruments. In addition to the energy efficiency value, other characteristic values can be specified in a mandatory manner.</p>
Sustainability Indicators	<p>In principle, all energy-related indicators that have already been mentioned for the Topten database can be used as indicators for calculating energy efficiency. In particular, these are:</p> <ul style="list-style-type: none"> • Energy intensity of the network [kWh/GByte] • Energy consumption per hour service usage [Wh/h] <p>By adjusting to the best and worst values occurring on the market across different technologies, the allocation to the efficiency classes A to G is created.</p> <p>As additional information, the following can be indicated on the label:</p> <ul style="list-style-type: none"> • Annual carbon footprint per subscriber [kg CO₂-eq./a*subscriber] • Specific carbon footprint of data transmission [g CO₂-eq./GByte] • Share of renewable energies of the network operator in total energy consumption [%]
Mechanism	<p>The energy efficiency label would provide environmental information on the telecommunication product directly at the point of sale and creates considerable market transparency. When customers compare different products, it would be very obvious to them which of the products is more energy-efficient or climate-friendly. Due to competitive pressure, those products that are particularly efficient would have a market advantage.</p>

Energy efficiency -type of label

Impact (environmental and economic)

Due to the significantly increased transparency compared to today, a shift in favour of climate-friendly telecommunication services would be expected. On the providers' side, costs would arise for determining the indicators, calculating the efficiency classes and communicating the energy efficiency label. For the companies that benefit from this measure because they offer efficient services, these costs could be compensated by the market advantage or reduced advertising costs. For companies with inefficient products, this would lead to additional costs. For national authorities, the introduction of another mandatory energy efficiency label would possibly lead to further efforts in market surveillance. However, as these public structures already exist, only minor additional costs are expected here.

Box 21: Feedback on an energy efficiency –type of label

[Only individual opinions can be reflected here and no representative survey took place.]

The energy efficiency label is seen by both some ECN providers and national regulatory authorities as possibly an appropriate policy measure to achieve environmental transparency. However, it must be said that these are individual opinions and not a representative survey of the entire sector.

Already now, the energy consumption of networks is monitored internally because there is a financial interest of the operators to keep consumption as low as possible. It therefore seems possible to process this data in a form that is also comprehensible to consumers. The hardware used in the network is already capable of providing many different monitoring data, more than are evaluated at this point. The energy efficiency label could build on this data and provide an incentive for optimising individual network components.

As consumers are overwhelmed with information, a standardised, recognisable label would be beneficial. Therefore, comparability must be ensured through standardised metering and the use of the same metrics across Europe. In order to also address the absolute resource consumption and to achieve the goal of climate neutrality, the label should contain relative and absolute figures on energy consumption (per service unit and company or network) and could be complemented by information on greenhouse gas emissions. To make the label easy to understand for consumers, all information should be summarised in a single (colour-coded) point value, with additional information below. This label should be visible to the consumer when concluding a contract. Additional information on energy efficiency could be given on bills or user accounts.

A progressive example of transparency is France. Here, according to article 13 of the French Circular Economy Law¹⁸¹, telecommunication network operators will be obliged starting from 1.1.2022, to provide their customers with information on the volumes of data transmitted and the associated greenhouse gases in bills or user accounts.

The reference values for the efficiency scale, which distinguish between efficient and inefficient networks, would need to be determined and specified. An ECN energy register (see corresponding policy option) could help to determine reference values for on a regular basis using statistical data.

The survey of consumer organisations (task 1.2.4) showed that an energy efficiency label was the second most popular option by the surveyed consumer organisations with a positive feedback from 8 out of 10. However, the option most preferred by consumer organisations and positively assessed by all (8/10 very well suited, 2/10 well suited) was the introduction of Ecodesign requirements for telecommunication services¹⁸².

Eco-label

Eco-label	
Description	An eco-label (e.g. EU-ecolabel) would be awarded to those telecommunications services that meet all the ecological criteria set out in a catalogue of requirements. The labelling of products is voluntary and can be used for marketing purposes.
Sustainability Indicators	<p>The requirements of an eco-label must be determined in a procedure defined by the standard for eco-labels (EN ISO 14024:2018). Energy efficiency and greenhouse gas emissions are again used as core indicators, which are also given a threshold value.</p> <ul style="list-style-type: none"> • Energy intensity of the access network [kWh/GByte] • Annual energy consumption per subscriber [kWh/(a*subscriber)] • Power consumption of the network per subscriber [W/subscriber]

¹⁸¹ LOI n° 2020-105 du 10 février 2020 relative à la lutte contre le gaspillage et à l'économie circulaire; <https://www.legifrance.gouv.fr/jorf/id/JORFTEXT000041553759/>

¹⁸² Ecodesign is not mentioned in the options proposed here because it is not a transparency measure. Instead, it imposes legal minimum requirements on products which, if they fall below them, may no longer be offered on the European market. Through Ecodesign, the responsibility remains at the companies and consumers are not expected to influence the market through their individual purchasing decisions. For other product groups (https://ec.europa.eu/info/energy-climate-change-environment/standards-tools-and-labels/products-labelling-rules-and-requirements/energy-label-and-ecodesign/energy-efficient-products_en), Ecodesign and energy efficiency labelling go hand in hand. Ecodesign sets the minimum requirements and labelling ensures competition for the most efficient products. The same approach would be conceivable for telecommunications services: a combination of ecodesign and energy efficiency labelling.

Eco-label	
	<ul style="list-style-type: none"> • Annual carbon footprint per subscriber [kg CO₂-eq./((a*subscriber))] • Specific carbon footprint of data transmission [g CO₂-eq./GByte] • Share of renewable energies of the network operator in total energy consumption [%] <p>Additional requirements could also be placed on material efficiency (contribution to the circular economy):</p> <ul style="list-style-type: none"> • Reducing E-waste volumes • Enhancing recycling • Preventing premature replacement of end-user equipment • Promoting the economical use of data volumes
Mechanism	<p>The eco-label acts as a so-called frontrunner instrument. A company can voluntarily highlight those products on the market that are particularly efficient and environmentally friendly with a trustworthy label. In this way, the company creates market advantages for these products. It is expected that aware consumers will react to such market signals and thus also encourage other suppliers to offer more eco-efficient products.</p>
Impact (environmental and economic)	<p>Eco-label requirements are used by the public sector as minimum requirements for green public procurement and by companies often as a benchmark for product development. Therefore, it could be that the ambitious standard set by the eco-label would gradually become established in the market. For companies, joining an eco-label is associated with costs for the collection of product indicators. Since participation is voluntary, only those companies will incur these expenses who expect that they will nevertheless have financial advantages as a result. In contrast, there are no direct costs for companies with inefficient products that do not participate. The development of eco-label criteria involves costs, usually for the public sector.</p>

Box 22: Feedback on an Eco-Label

[Only individual opinions can be reflected here and no representative survey took place.]

If there is one centralized label, the verification process to assert the compatibility of a multitude of actors can be time consuming and often impossible to handle. At the opposite, the decentralization of the verification process can create disparities in the process and a need to control the auditors.

From the perspective of surveyed consumer protection organisations (task 1.2.4), an eco-label is the third best option with 7 positive responses from 10 organisations. A voluntary

eco-label would only be applied to telecom services that are particularly environmentally friendly and would not bring transparency to inefficient products and such services for which providers choose not to apply for an eco-label.

3.3.2. Comparison of the different policy options

In principle, only those policy options for transparency measures have been selected in this proposal that are considered feasible and target-oriented overall by this study. The different policy options all have their advantages and disadvantages. The following Table 45 is intended to provide an overview of where possible advantages and disadvantages are seen. In the table, points (-) and (+) are assigned to give a quick overview of the ranking of the different impacts. The rationale for this ranking is given in the following sections.

Table 45: Policy options for enhancing the efficiency of ECNs

Policy option	Level of indicators	Bindingness	Environmental Impact	Consumer awareness	Remaining research
ECN Energy Register	Company wide	Voluntary or mandatory	High (+++)	Low, professional customers only (+)	Defining efficiency metrics (-)
Code of Conduct on transparency measures for telecommunication services	Company wide	Voluntary	Medium (++)	Medium (++)	Defining efficiency metrics (-)
Topten product database	Per product	Voluntary	Medium (++)	Low (+)	Defining efficiency metrics and thresholds (--)
Energy efficiency –type of label	Per product	Mandatory	High (+++)	High (+++)	Defining efficiency metrics (-)
Eco-label	Per product	Voluntary	Medium (++)	High (+++)	Defining efficiency metrics, other ecological requirements and thresholds (---)

Source: Oeko-Institut

Level of indicators

- The five policy options differ in the level at which they assess environmental impacts. The **ECN Energy Register and the CoC report at the company level** and only differentiate according to regional allocation (e.g. national state). This means that if a company offers its services in several countries, it would need to record energy consumption and other indicators in the region in which it is economically active. This separation makes sense in order to enable comparability between regional suppliers (e.g. same greenhouse gas emissions for electricity from the general electricity grid or same climatic conditions).
- The remaining three policy options **refer to the respective telecommunications service offered** (product level). A regional distinction must also be made here, for example by allocating the product to a climate zone where it is provided or if it is provided in an urban or a rural area. In addition, technical specifications have to be given (access network type, fixed or mobile).

Bindingness

- A distinction is made between **voluntary and obligatory policy options**.
- The first option, **ECN Energy Register, can be introduced both voluntarily and obligatory**. It is expected that at this aggregated level of the company there is a willingness to fill this register with data. Other incentives could also contribute to this, such as the fact that entry in the register is a prerequisite for participating in public tenders or obtaining concessions for the use of public infrastructure.
- The **Code of Conduct on transparency measures for telecommunication services** is defined as an voluntary instrument. It could contribute to a voluntary ECN Energy Register.
- The two policy options **Topten database and Eco-label are purely voluntary measures**. Here, a company would be interested in participating if it expects to gain competitive advantages. Since only efficient services are included in the database or labelled with the eco-label, there would be no reason for companies to avoid this transparency measure.
- An **energy efficiency –type of label**, on the other hand, would be **mandatory**. Here, services are labelled regardless of whether they are efficient or inefficient. In order to achieve transparency for end-users, it is necessary that all ECN and ECS operators use this label. If the energy efficiency label was voluntary, inefficient companies could avoid this labelling and thereby possibly even achieve unjustified competitive advantages.

Environmental Impact

- The environmental impact of policy options is particularly high if many companies are affected and if many of their products are covered.

- The instruments **ECN Energy Register and energy efficiency label** are therefore particularly efficient, because all market participants would be affected. Their environmental **impact is considered to be high**.
- The impact of a **Code of Conduct** as a voluntary instrument depends on the number of participants. It is expected that it would have a slightly lower impact than a obligatory instrument but still a **medium impact** due to rising awareness of customers.
- The two information instruments on efficient products, Topten database and Eco-label, would only refer to a smaller section of the products available on the market. Their impact is seen primarily in their exemplary function. The environmental impact of these instruments is rated as medium.

Consumer awareness

- The study investigated what characteristics an information tool must have in order for end users to accept it and change their behaviour in the choice of a provider or when using the respective service as a result. The prerequisite for this is first of all that the tool is known and accepted as credible.
- An ECN Energy Register is primarily aimed at B2B customers and not at consumers. As a result, its impact in promoting consumer awareness is rated low. It is expected that the register would at most influence the choice of provider, but not the usage behaviour in relation to individual services.
- A Code of Conduct on transparency measures for telecommunication services would itself not have any effect on consumer awareness. However, the fact that standardised rules for communication are laid down here leads to competition among the telecommunications providers and to a higher credibility of the advertising statements made by the companies. As a result, the instrument is considered to be medium effective.
- The Topten product database is in principle a good tool for interested consumers. However, awareness of its availability is comparatively low and there is no direct link between the purchase decision and the search within this database. The effect on consumer awareness is therefore rated as low.
- The energy efficiency label is very well known due to its presence in electronics markets (on large household appliances). With a mandatory introduction, it would therefore also be quickly understood for telecommunications services and included in consumer decisions due to its appearance at the point of sale. Its effect on raising awareness is therefore considered to be high. Since the energy label is directly linked to individual services and must also be shown when these products are sold, it is also a tool that could influence the conscious use of products, in addition to supporting the choice of provider.
- Eco-labels also have a high level of awareness and, in addition, a high level of credibility. If a product is labelled with an eco-label, the purchase decision of consumers in favour of this product is comparatively easy. The effect of an eco-label to reach the awareness of end users is therefore rated as high. The eco-label is

expected to contribute primarily to the selection of an energy-efficient provider. The usage behaviour of the individual user, on the other hand, will not be influenced, as he or she would not receive any information about the individual environmental impact of his or her behaviour.

Remaining research

- The five policy options presented are not yet mature and would need to be developed through further research or standardisation activities. In particular, it must be ensured through further standardisation that the efficiency ratios of telecommunications services are reliably determined and that the values of different services are thereby comparable with each other. A low degree of standardisation could be an invitation to misuse and greenwashing. The respective effort, which means both time and financial resources, was therefore assessed at a high level. A distinction is made between low, medium and high research effort.
- For the three options ECN Energy Register, Code of Conduct and energy efficiency label there is a comparatively low remaining research effort. The metrics for determining the energy efficiency of networks are mostly developed and only need to be introduced in a binding manner.
- In contrast, there is a higher research effort for a Topten product database. Here, suitable minimum criteria must also be developed that highlight particularly energy-efficient products compared to inefficient products. The remaining research effort is medium.
- The highest research effort is required for an eco-label for telecommunications services. In addition to the minimum criteria, further environmental criteria (e.g. for aspects of the circular economy) must be developed here in the sense of a comprehensive assessment.

3.3.3. Ranking of policy options for transparency measures for ECNs

The comparison of the different policy options makes it possible to assign indicative points to the individual properties. This has been done in Table 45 in the last section by assigning (+) and (-) properties. Each plus is counted as one point, for each minus one point is deducted. This allows a ranking of the different options.

The following order of precedence results from the scoring:

- 1. Energy efficiency –type of label** (5 points)
- 2. ECN Energy Register** (3 points)
- 3. Code of Conduct on transparency measures** (3 points)
- 4. Eco-label** (2 points)
- 5. Topten product database** (1 point)

The **preferred option** on this basis is the labelling of telecommunication services with an **energy efficiency label**. This option is the one with the highest environmental impact and

consumer attention according to the assessment of the authors of this study. Initial feedback from individual stakeholders in the online presentations indicates that this could be an acceptable option. As the feedback contained only a limited number of individual opinions, further stakeholder surveys should be conducted as part of the energy efficiency label development to examine whether the sector as a whole could work with this approach. The surveyed consumer organisations see energy labelling as the second best option. From the consumer organisations' point of view, more effective would be legal minimum requirements in the form of **Ecodesign regulation for telecommunication services**. In practice, both options Ecodesign and energy efficiency label could also be introduced at the same time, which is already the case for other Ecodesign product groups.

The **ECN Register** represents the second priority by the indicative scoring points. Feedback from stakeholders in the online presentations shows that this is mainly seen as a tool for professional buyers and for regulators and less as a tool for consumer information.

The **Code of Conduct on transparency measures** has the same number of points as the ECN register. Due to its voluntary character and the lower environmental impact that is expected from this, it is ranked as the third priority. The surveyed consumer organisations made it clear in the online survey that they consider voluntary commitments by suppliers to be problematic and that the effect could even be negative.

The two instruments **Eco-Label** and **Topten product database** are considered by the authors of this study lower priority. This assessment is also shared by the individual stakeholders at the online presentations. Due to the rapid technical development, the effort to update such consumer databases is very high and the minimum requirements for an eco-label would have to be constantly renewed. Regardless of the practical feasibility, however, the surveyed consumer associations consider at least the eco-label to be an easily communicable tool and rate it as the third best solution.

3.4. Conclusions: towards more energy and resource efficient data centres and options for a transparency mechanism for electronic communications services and networks

The objectives of this study are:

Concerning data centres and cloud computing:

- To propose policy measures for increasing the energy and resource efficiency of data centres and assess the environmental, social and economic impact.
- In support of that objective to perform:
 - An analysis of data centre definitions and types and determine meaningful size thresholds;
 - An analysis of current market practices related to circularity and identify potential ways to increase circularity;
 - An analysis of standards, metrics, indicators, methods and methodologies that are currently used in the field for assessing energy and resource efficiency and an assessment of their suitability for inclusion in policy measures

- To identify gaps in the value chains where potential for energy efficiency and/or circularity is lost and potential measures to bridge these gaps;

Concerning electronic communications services and networks:

- To propose policy options that could be included in a transparency mechanism on the environmental footprint of ECNs and in view of this:
 - To report practices, indicators, standards and methodologies across the industry related to the environmental footprint of electronic communications networks and services;
 - To report on sustainability aspects of the service offered to consumers (in particular to assess a number of possible indicators in view of end-user communication and for analysing the impact of a voluntary and mandatory transparency mechanism on the environmental footprint of electronic communications services and on relevant stakeholders.
- To consider criteria for the assessment of the environmental sustainability of new electronic communications networks.

In this chapter we present the conclusions for each of the two segments of the ICT value chain under study: 1) data centres and cloud computing and 2) electronic communication services and networks.

3.4.1. Data centres and cloud computing

On the basis of careful analyses, stakeholder feedback from surveys, interviews, and more prominently from the online workshop, a number of policy measures can be proposed that are feasible, effective and specifically targeted to data centres and cloud computing. In our view a combination of (i) improvements to the Code of Conduct, (ii) compulsory green public procurement criteria for publicly procured data centres, server rooms and cloud services and (iii) the set-up of a European Data Centre Registry would be advisable. Evidently other measures are interesting and useful as well, yet appear to be more focussed on particular aspects of data centres and cloud computing or rather indirectly affecting their energy and resource efficiency.

The **Code of Conduct** is an important instrument in greening data centres. In this study a number of potential improvements have been assessed. Consultation with the stakeholders indicates that it is important to maintain the best practice approach and that its voluntary nature should be kept. Setting quantitative energy efficiency goals was perceived as challenging due to large regional differences across the EU in terms of climate, access to renewable energy sources and business models. An EU level playing field is key. Nevertheless in our view introducing a widely accepted quantitative energy efficiency target such as the PUE in combination with ranges that reflect differences in regional conditions and a classification of data centres should be feasible. Third-party monitoring is perceived as having a value added provided that the independence of the certifiers and confidentiality of the information can be guaranteed. In view of the perceived benefits of an improved version of the CoC, methods for increasing participation are valuable. Especially initiatives that reach out to SME data centres are welcomed, both to disseminate the expertise to implement the best practices as well as improvements in financing and business model development.

The change from voluntary to **mandatory GPP criteria** for publicly procured data centres and cloud services would not only have an important signal function from authorities putting action to word in their own areas of operation, but would also foster the greening of data centres and cloud computing services overall. It has to be admitted that the private market segment is by and far much larger. Yet in view of the increasing digitalisation of government services the public segment can create a critical mass and lead market in the data centre and cloud services segment. As with the CoC also with this measure an EU level playing field is important, as well as equal access to the public data centre procurement market for small data centres.

The third most feasible policy measure is creating a **European Data Centre Registry** where energy consumption and material use are transparently reported. The registry can be developed parallel and in consistency with the CoC improvement and mandatory GPP criteria indicated above. Critical points to be resolved are the treatment of confidential business information, the precise definition of indicators to be provided, and the control and management of the Registry. These are not unsurmountable challenges which can be adequately solved using e.g. a mutually agreed protocol between the data centre operators and the organisation responsible for the Registry. The Registry would be instrumental in monitoring and analysing the progress towards greening data centres, as well as in providing valuable market information for the stakeholders.

Stricter requirements for the **Ecodesign Regulation on servers and data storage products** are instrumental to greening data centres and cloud computing. Yet the ultimate contribution to energy efficiency also depends on the entire operational process as well as the business model used. At the time of the study the Regulation is under review. After the adoption of the amendments which focus on a methodology to measure active and idle state power, it would be useful issuing an ecodesign preparatory study defining the minimum requirements for active and idle state performance, resource efficiency and operational conditions.

Although workshop participants indicated that access to finance is not a problem for DCs, the **Sustainable Finance Taxonomy Climate Delegated Act** remains a valuable policy measure that can facilitate investments in the refurbishment and introduction of new and greener technologies in DCs. In this context the streamlining with the eligibility criteria for Important Projects of Common European Interest, which at the time of the study are under revision, is important.

In combination with the EU Data Centre Registry and third-party control a voluntary **self-regulation initiative** might be worth considering. Yet opinions remain divided about the ultimate effectiveness of such an initiative.

Other policy measures that are not directly targeted at data centres such as EMAS, the EED, the WEEE Directive, the CSR Directive, the EPBD, the Green Claims, do have an effect on greening data centres, yet rather in an indirect manner. These measures surely help shaping a favourable regulatory environment, yet given that data centres and cloud computing services are the prime target of this study, and the indirect nature of these measures, these policy measures are not main candidates for greening data centres and cloud computing. However it remains important to guard the consistency and coherence between the direct measures, in particular the CoC and mandatory GPP, and the other measures as this would

reduce compliance costs, create (lead) market leverage and as such increase the energy and resource efficiency of data centres.

Evidently policy measures need to be implemented and one of the key hindrances that need to be overcome in this respect is the myriad of concepts and **definitions of data centres** and the metrics to measure energy and resource efficiency. We analysed the various concepts that are used at the time of the study and concluded that it is recommended to use the definition in the CoC as a starting basis and further align it with the one of the EN50600 standard and then add these to the participant or best practice guidelines documents. At the same we recommend avoiding the use of the term 'managed service provider' to prevent confusion. More detail is provided in chapter 2.1. (Task 1.1.1.) where we among others present a taxonomy of DCs, and chapter 3.2. (Task 2.1.) where we analyse the definition in the context of applications for policy measures.

Concerning the **methods for measuring the energy and resource efficiency of data centres** (task 1.1.3) our analyses have shown that there are already a large number of different methods and metrics that focus on data centres and their individual components. Particularly useful are the metrics from the European Data Centre Standard EN 50600-4 key performance indicators (KPIs) series, some of them still under development, which very systematically describe the different environmental characteristics of data centres and support them with measurement methods. However the existing metrics have a clear focus on energy-related issues, and circular economy aspects are still insufficiently covered by the metrics. With regard to climate protection, leakage quantities of refrigerants from cooling systems and the associated greenhouse gas emissions are still insufficiently recorded.

Despite the challenges in terms of definitions and metrics, we conclude that by pursuing the three policy measures namely (i) improvements to the Code of Conduct, (ii) compulsory green public procurement criteria for publicly procured data centres, server rooms and cloud services and (iii) the set-up of a European Data Centre Registry and by simultaneously implementing coherent specifications in other (indirect) policy measures a favourable regulatory environment can be established that fosters greening of data centres and cloud computing, both for large multinational data centres as well as for SMEs operating in the edge segment.

3.4.2. Electronic communications services and networks

In view of the EU Green Deal and related policy strategies at EU and Member State level, a framework has to be established that incentives for the operators of electronic communication networks to use communication technology that is as energy-efficient as possible and also sustainable in other respects, and to operate existing networks in a climate-friendly manner. With the present study, such indicative framework conditions and possible mechanisms for ECNs were assessed, especially with regard to energy efficiency and greenhouse gas emissions.

The study comes to the conclusion that there are currently **two main areas of focus to the ecological optimisation of telecommunications infrastructures**:

- The first focus is the **deployment of energy efficient network infrastructure**, for example in the construction of new mobile radio base stations or antennas, new fixed Internet access cabinets or the deployment of broadband cables.

- The second focus is the **provision of eco-friendly telecommunications services by ECN operators**, i.e. mobile telephony or broadband contracts, fixed telephone connections, fixed internet connections, business-to-business data lines, cable TV or other services that require a fixed or mobile connection to the electronic communications network.

Deployment of new network components

For the planning of new networks, the ECN sector has developed a variety of metrics (see tasks 1.2.3 and 1.2.5) to determine the energy efficiency of the components used already in the planning phase and to build energy-optimised systems.

This practice could be further promoted by giving particularly energy-efficient networks a more favourable treatment, for instance in permit granting (e.g. accelerated procedures), in the use of public infrastructure (roads, cable ducts, facilities, frequencies), or in the selection procedures for state aid projects. This could be based on indicators such as the energy intensity of the network [kWh/GByte].

In addition the study proposes that telecom operators record the energy intensity of the network in a central or national register (**ECN Energy Register**), similar to the register proposed for data centres, in order to create an overview of the different providers and the efficiency of the different network technologies. Regulators, professional buyers as well as investors or financial institutions can get an overview of the efficiency of the respective provider by comparing within the database. The data contained in the proposed ECN energy register should be made available in such a transparent way that it can be further processed, for example to generate information for end-users on the efficiency of providers.

Transparency towards customers in the delivery of telecommunication services

One of the objectives of this study was to investigate what transparency measures by ECN providers could help to ensure that customers of telecommunication services can choose energy-efficient offers, thus creating competition for the most environmentally friendly services (see task 1.2.4). For this purpose, various metrics were considered as well as the opinions of consumer protection organisations were surveyed. The most promising transparency measure identified in this study is the **introduction of an energy efficiency –type of label for telecommunications services**. The specific energy consumption of the communication service could be shown on the label in a colour scale as well as a classification from A to G. The label could also include information on the carbon footprint of the service and the share of renewable energies used. When selling and advertising telecommunication services, the energy efficiency label would need to be shown. The existing instrument is already very well established on the market for many electrical appliances (lamps, refrigerators, washing machines, air conditioners, etc.) and it therefore offers good conditions for it to be well accepted by consumers. However, it should be noted that in addition to methodological challenges, the existing efficiency label is currently assigned for physical products (goods) and could not be used for services. In addition to private customers, the information provided by the energy efficiency label could also be used by professional buyers and the public sector in the context of green public procurement (GPP). As a metric on which the efficiency scale is based, various options were discussed in the study. It is important for a suitable metric that it

should not be a pure performance metric that for example assumes maximum data traffic, but that the **energy demand must be related to an understandable and realistic usage unit** (e.g. per connection, per average subscriber or per hour of usage). In order to identify the best calculation method for the efficiency indicator, more research is therefore needed in the further design of a possible energy efficiency –type of label.

Establishing minimum efficiency requirements for deployment and Ecodesign requirements

Both proposed policy options (ECN energy register and energy efficiency label) are information tools that are intended to promote competition for the most efficient telecom service. So far, information on the energy efficiency of telecommunication networks and services is still very scarce. Network operators typically do not make such information publicly available. Therefore, it is also not possible to identify what energy consumption is appropriate for an electronic communications network and what threshold values can be defined to exclude particularly inefficient networks or services from the market. After an introduction of the transparency measures mentioned above, however, this data situation would change. The evaluation of the data in the proposed ECN energy register and the information on the energy efficiency label per telecom service would create the basis for identifying inefficient systems and services.

In addition to the transparency measures, **two further policy instruments are therefore proposed, establishing minimum requirements**, which could be considered to introduce as a next step in the coming years:

- When new network infrastructure components are installed, a **minimum efficiency requirement for new infrastructure** could ensure that inefficient network systems are no longer granted licences or permits for deployment. This will prevent establishing inefficient network infrastructures.
- With regard to telecommunication services, it could also be considered to introduce **minimum requirements through Ecodesign –type of requirements** in a step following the transparency measures. This instrument is well established under the Ecodesign Directive (2009/125/EC). However, it should be noted that the existing instrument applies to “energy-related products”, defined as goods, and not to services. Ecodesign requirements define the minimum environmental characteristics that must be met before a product (or service) can be offered on the European market. The most inefficient services could thus be excluded from the market and telecom providers can be further motivated to offer particularly energy-efficient and climate-friendly services. As this is a very far-reaching instrument that intervenes strongly in the market, further studies on the economic, social and ecological effects of this instrument would have to be carried out beforehand.

Glossary and list of acronyms

Acronyms	Full meaning
3G, 4G, 5G	Respectively third, fourth and fifth generation cellular communications network technology
3DP	3D Printing
ADSL	Asymmetric Digital Subscriber Line
AI	Artificial Intelligence
ASHRAE	American Society of Heating, Refrigerating and Air Conditioning Engineers
BEREC	Body of European Regulators for Electronic Communications
BRP	Building Renovation Passport
CDN	Content Delivery Network
CDP	Carbon disclosure project
CEEDA	Certified Energy Efficiency Data Centre Award (UK)
CEN	European Committee for Standardization
CENELEC	European Committee for Electrotechnical Standardization
CO ₂ -eq	Carbon dioxide (equivalents)
CoC	Code of Conduct
CoLo	Colocation data centre
CPU	Central processing unit
CSR report	Corporate social responsibility or sustainability report
CSRD	Corporate Sustainable Reporting Directive
DCs	Data Centres
DG CONNECT	The Directorate-General for Communications Networks, Content and Technology of the European Commission
DLT	Distributed Ledger Technology

DNSH	Do not significantly harm criteria
EC	European Commission
ECN	Electronic Communications Network
ECS	Electronic Communications Service
EEA	European Economic Area
EED	Energy Efficiency Directive
EEE	electrical and electronic equipment
EMAS	Eco-Management and Audit Scheme
EMF	electromagnetic field
EPBD	Energy Performance of Buildings Directive
EPC	Energy Performance Certificates
ESO	European Standards Organisation
ETSI	European Telecommunications Standards Institute (one of the ESOs besides CEN and CENELEC)
EU	European Union
FAN	Fixed Asset Network
FWC	Framework contract
FTTH	Fiber To The Home network
GDC	Green Data Centre
GHG	Greenhouse gas
GRI	Global Reporting initiative
Gt	Giga tonnes
GWP	Global warming potential
HDD	Hard Disk Drive
ICCP	Intergovernmental Panel on Climate Change
ICT	Information and communication technologies,

IoT	Internet of Things
IPCEI	Important Projects of Common European Interest
ISAE	International Standard on Assurance Engagements
ISO 14040/44,	International standard for Life Cycle Assessments
JAC	Joint Audit Cooperation
JRC	Joint Research Centre of the European Commission
KPI	Key performance indicators
LCA	Life Cycle Assessments
LTE	Long-Term Evolution technology
LTRS	Long-term Renovation Strategies
MEPS	Mandatory minimum Energy performance Standards
MS	Member States
MSP	Managed Service Providers
NFRD	Non-financial Reporting Directive
NFV	Network Functions Virtualisation technologies
NIEE	Total Network Infrastructure Energy Efficiency
NZEB	Nearly Zero-energy Buildings
OCP	Open Compute Project (OCP)
PCF	Product Carbon Footprint
PDU	(data centre) Power Distribution Unit
PEF	Product Environmental Footprint
PEFCR	Product Environmental Footprint category rules
POP	Point of Presence
PSU	Power supply unit
PUE	Power usage effectiveness of data centres
RAN	Radio Access Network

ROI	Return On Investment
SASB	Sustainability Accounting Standards Board
SCM	Standard Cost Model
SDN	Software Defined Networking
SFDR	Sustainable Finance Disclosure Regulation
SFT	Sustainable Finance Taxonomy
SRI	Smart Readiness Indicator
TCE	Total Cost to the Environment
TCO	Total Cost of Ownership
TEG	Technical Expert Group on Sustainable Finance
ToR	Terms of references
TRL	Technology Readiness Level
TSSP	Thematic Smart Specialisation Platform
TWh	Tera-Watthours
UMTS	Universal Mobile Telecommunications System
UPS	Uninterruptible Power Supply
VDSL	Very high-speed Digital Subscriber Line
WAN	Wide Area Network
WEEE	Waste Electrical and Electronic Equipment

References

- Acton, M.; Bertoldi, P.; Booth, J. (2020): 2020 Best Practice Guidelines for the EU Code of Conduct on Data Centre Energy Efficiency. Version 11.1.0 (Final Version). European Commission, Ispra, 2020, JRC119571. Available online at https://e3p.jrc.ec.europa.eu/sites/default/files/documents/publications/jrc119571_jrc119571_2020_best_practice_guidelines_v11.1.0a_br_ma_21_jan.pdf, checked on 1/14/2021.
- Alfieri, F., Dodd, N., Gama-Caldas, M., Wolf, O., Maya-Drysdale, L., Huang, B., Viegand, J., Flucjer, S., Tozer, R., Whitehead, B., Brocklehurst, F., (2019) Development of European Green Public Procurement Criteria for Data Centres – Preliminary report, JRC Technical Report, EUR 29945 EN, Publications Office of the European Union, Luxemburg, 2019, ISBN 978-92-76-10382-0, doi:10.2760/327087, JRC118550.
- Alger, Douglas (2010): Grow a Grenner Data Center. Chapter 2: Measuring Green Data Centers. Available online at https://cdn.tgtmedia.com/searchSystemsChannel/downloads/Growing_a_Green_Data_Center_9781587058134_CH02.pdf, checked on 12/29/2020.
- Al-Shehri, Salman M.; Loskot, Pavel; Numanoglu, Tolga; Mert, Mehmet (n.d.): Common Metrics for Analyzing, Developing and Managing Telecommunication Networks. Available online at <https://arxiv.org/ftp/arxiv/papers/1707/1707.03290.pdf>, checked on 1/14/2021.
- Andor, Mark; Gerster, Andreas; Sommer, Stephan (2017): Consumer Inattention, Heuristic Thinking and the Role of Energy Labels. Essen (Ruhr economic papers, 671). Available online at http://www.rwi-essen.de/media/content/pages/publikationen/ruhr-economic-papers/rep_17_671.pdf.
- Andrae A.S.G. (2020) Hypotheses for primary energy use, electricity use and CO2 emissions of global computing and its shares of the total between 2020 and 2030. WSEAS TRANSACTIONS on POWER SYSTEMS DOI: 10.37394/232016.2020.15.6 <https://www.wseas.org/multimedia/journals/power/2020/a125116-083.pdf>
- BEREC (2020): BEREC Report on the outcome of the public consultation on the draft BEREC Work Programme 2021. BEREC - Body of European Regulators for Electronic Communications. Available online at https://berec.europa.eu/eng/document_register/subject_matter/berec/download/0/9719-berec-report-on-the-outcome-of-the-publi_0.pdf, checked on 3/10/2021.
- Bertoldi, P. ; Avgerinou, M.; Castellazzi, L. (2017) Trends in data centre energy consumption under the European Code of Conduct for Data Centre Energy Efficiency, EUR 28874 EN, Publications Office of the European Union, Luxembourg, 2017, ISBN 978-92-79-76445-5, doi:10.2760/358256, JRC108354
- Bertoldi, P; Lejeune, A (2020): Code of Conduct on Energy Consumption of Broadband Equipment. Version 7.1. European Commission, Ispra 2020, JRC119761. Available online at <https://e3p.jrc.ec.europa.eu/publications/eu-code-conduct-energy-consumption-broadband-equipment-version-71>, checked on 1/23/2021.
- Berwald, Anton; Faninger, Thibault; Bayramoglu, Sara; Tinetti, Benoît; Mudgal, Shailendra; Stobbe, Lutz; Nissen, Nils (2015): Ecodesign Preparatory Study on Enterprise Servers and Data Equipment. ENTR Lot 9. Edited by European Union, checked on 1/14/2021.
- BfR (2010): Grenzen und Möglichkeiten der Verbraucherinformation durch Produktkennzeichnung. With assistance of W. Konrad, D. Scheer. Edited by A. Epp, S.

Kurzenhäuser, R. Hertel, G.-F. Bö. Bundesinstitut für Risikobewertung (BfR). Institut für ökologische Wirtschaftsforschung – IÖW.

Blackburn, Mark (2012): Data Center Storage Efficiency Metrics. The Green Grid Forum 2012. Available online at <https://www.thegreengrid.org/en/resources/library-and-tools/145-2012-Forum-%E2%80%93Data-Center-Storage-Efficiency-Metric>, checked on 1/14/2021.

Blue Angel, The German Ecolabel (Ed.) (2019): Energy Efficient Data Center Operation. Blue Angel, The German Ecolabel, Basic Award Criteria Edition January 2019, Version 1. Available online at <https://produktinfo.blauer-engel.de/uploads/criteriafile/en/DE-UZ%20161-201901-en%20Criteria-2019-03-21.pdf>, checked on 5/31/2021.

Booth, John (2019): D8.6 Green DC Energy Efficiency Roadmap V1. CATALYST.D8.6.GIT.WP8.v1.0 (H2020-EE-2016-2017), checked on 1/5/2021.

Booth, John (2020): D8.11 Green DC Energy Efficiency Roadmap V2. CATALYST.D8.11.GIT.WP8.v1.0 (H2020-EE-2016-2017). Available online at https://project-catalyst.eu/wp-content/uploads/2020/09/CATALYST.D8.11.GIT_.WP8_.V1.0package.pdf, checked on 1/20/2021.

Brill, Kenneth G. (2007): Data center energy efficiency and productivity. The Uptime Institute. Available online at <http://large.stanford.edu/courses/2017/ph240/yu2/docs/brill.pdf>, checked on 12/30/2020.

Brotherton, Heather M. (2013): Datacenter Efficiency Measures, checked on 12/30/2020.

Canfora P., Gaudillat P., Antonopoulos I., Dri M., (2020) Best Environmental Management Practice in the Telecommunications and ICT Services sector, EUR 30365 EN, Publications Office of the European Union, Luxembourg, 2020, ISBN 978-92-76-21574-5, doi:10.2760/354984, JRC121781

Carbon Trust (2020): Product carbon footprint labelling. Consumer research 2020. Available online at <https://prod-drupal-files.storage.googleapis.com/documents/resource/restricted/Product-carbon-footprint-labelling-report-v3.pdf>.

Chinnici, M.; Capozzoli, A.; Serale, G. (2016): Measuring energy efficiency in data centers. In Ciprian Dobre, Fatos Xhafa, M. Chinnici, A. Capozzoli, G. Serale (Eds.): Pervasive computing. Next generation platforms for intelligent data collection. Amsterdam, Boston: Elsevier/AP Academic Press is an imprint of Elsevier (Intelligent data-centric systems).

CISCO (2020): 2019 Corporate Social Responsibility Report. Available online at https://www.cisco.com/c/dam/m/en_us/about/csr/csr-report/2019/_pdf/csr-report-2019.pdf.

Consumer Focus (2012): Under the influence? Consumer attitudes to buying appliances and energy labels, checked on 12/21/2015.

Define (2017): Broadband Fibre Qualitative Research. Final Report. Edited by Define research & insight. Available online at <https://www.asa.org.uk/uploads/assets/uploaded/d791272c-805a-495d-8e25650af1740ab7.pdf>.

Dodd, N., Alfieri, F., Maya-Drysdale, L., Viegand, J., Flucker, S., Tozer, R., Whitehead, B., Wu, A., Brocklehurst F., (2020) Development of the EU Green Public Procurement (GPP) Criteria for Data Centres Server Rooms and Cloud Services, Final Technical Report,, EUR 30251 EN, Publications Office of the European Union, Luxembourg, 2020, ISBN 978-92-76-19447-7, doi:10.2760/964841, JRC118558

- EDNA (2019): Intelligent Efficiency For Data Centres & Wide Area Networks. Report Prepared for IEA-4E EDNA. Available online at <https://www.iea-4e.org/document/428/intelligent-efficiency-for-data-centres-and-wide-area-networks>, checked on 1/29/2021.
- Egmond, C.; Bruel, R. (2007): Nothing is as practical as a good theory,. Analysis of theories and a tool for developing interventions to influence energy-related behaviour. Available online at http://www.cres.gr/behave/pdf/paper_final_draft_CE1309.pdf.
- Egmond, C.; Jonkers, R.; Kok G. (2005): A strategy to encourage housing associations to invest in energy conservation. In Energy Policy (33), pp. 2374–2384. Available online at <https://www.sciencedirect.com/science/article/abs/pii/S0301421504001600>, checked on 7/30/2021.
- EN ISO 14024:2018: Environmental labels and declarations - Type I environmental labelling - Principles and procedures (ISO 14024:2018).
- Energy Star (2018): ENERGY STAR Score for Data Centers in the United States. Technical Reference. Available online at https://www.energystar.gov/sites/default/files/tools/Data_Center_August_2018_EN_508.pdf, checked on 12/30/2020.
- Ericsson (2020): Ericsson Mobility Report. Available online at <https://www.ericsson.com/4adc87/assets/local/mobility-report/documents/2020/november-2020-ericsson-mobility-report.pdf>.
- ETSI EN 303 470 V1.1.0 (2019): ETSI EN 303 470 - V1.1.0 - Environmental Engineering (EE); Energy Efficiency measurement methodology and metrics for servers, checked on 1/14/2021.
- ETSI ES 203 136 v1.2.1 (2017): ES 203 136 - V1.2.1 - Environmental Engineering (EE); Measurement methods for energy efficiency of router and switch equipment, checked on 1/13/2021.
- ETSI ES 203 199 V1.2.1: ES 203 199 - V1.2.1 - Environmental Engineering (EE); Methodology for environmental Life Cycle Assessment (LCA) of Information and Communication Technology (ICT) goods, networks and services, checked on 2/9/2021.
- ETSI ES 205 200-2-1 (2014): ETSI ES 205 200-2-1 - V1.2.1 - Access, Terminals, Transmission and Multiplexing (ATTM); Energy management; Global KPIs; Operational infrastructures; Part 2: Specific requirements; Sub-part 1: Data centres, checked on 1/17/2021.
- European Commission (2010): A Digital Agenda for Europe. Communication from the Commission to the European Parliament, the Council, the European Economic and Social Committee and the Committee of the Regions. COM(2010)245 final. Available online at <https://eur-lex.europa.eu/LexUriServ/LexUriServ.do?uri=COM:2010:0245:FIN:EN:PDF>, checked on 3/10/2021.
- European Commission (2013): ICT footprint. Pilot testing on methodologies for energy consumption and carbon footprint of the ICT-sector. SMART-Nr 2011/0078. Ecofys; Quantis; BIO Intelligence Service. Available online at https://ec.europa.eu/newsroom/dae/document.cfm?doc_id=1710, checked on 3/10/2021.
- European Commission (2014): Directive 2014/61/EU of the European Parliament and of the Council of 15 May 2014 on measures to reduce the cost of deploying high-speed electronic communications networks. Available online at [269](https://eur-</p>
</div>
<div data-bbox=)

lex.europa.eu/legal-content/EN/TXT/PDF/?uri=CELEX:32014L0061&from=EN, checked on 3/10/2021.

European Commission (2017): Regulation (EU) 2017/1369 of the European Parliament and of the Council of 4 July 2017 setting a framework for energy labelling and repealing Directive 2010/30/EU. Available online at <https://eur-lex.europa.eu/legal-content/en/TXT/?uri=CELEX%3A32017R1369>, checked on 8/16/2021.

European Commission (2018a): Assessment of different communication vehicles for providing Environmental Footprint information. Final Report. Francisco Lupiáñez-Villanueva, Pietro Tornese, Giuseppe A. Veltri and George Gaskell. Presented in consortium by LSA & Partner. European Commission. Directorate General Environment. Directorate A – Green Economy. ENV.A.1 – Eco-Innovation & Circular Economy. Available online at https://ec.europa.eu/environment/eusds/smgp/pdf/2018_pilotphase_commreport.pdf.

European Commission (2018b): Product Environmental Footprint Category Rules Guidance. Version 6.3 – May 2018. Available online at https://ec.europa.eu/environment/eusds/smgp/pdf/PEFCR_guidance_v6.3.pdf, checked on 8/6/2021.

European Commission (2018c): Report from the Commission to the European Parliament and the Council. on the implementation of Directive 2014/61/EU of the European Parliament and of the Council of 15 May 2014 on measures to reduce the cost of deploying high-speed electronic communications networks. Available online at <https://eur-lex.europa.eu/legal-content/EN/TXT/?uri=COM%3A2018%3A492%3AFIN>, checked on 3/10/2021.

European Commission (2019a): Special Eurobarometer 490. Climate Change. Conducted by Kantar Public at the request of Directorate-General for Climate Action. Survey coordinated by the Directorate-General for Communication (DG COMM 'Media monitoring and Eurobarometer' Unit). Available online at <https://europa.eu/eurobarometer/api/deliverable/download/file?deliverableId=70456>.

European Commission (2019b): Single Market for Green Products - The Product Environmental Footprint Pilots - Environment - European Commission. Available online at https://ec.europa.eu/environment/eusds/smgp/ef_pilots.htm, updated on 12/31/2019, checked on 8/6/2021.

European Commission (2020a): Commission Recommendation (EU) 2020/1307 of 18 September 2020 on a common Union toolbox for reducing the cost of deploying very high capacity networks and ensuring timely and investment-friendly access to 5G radio spectrum, to foster connectivity in support of economic recovery from the COVID-19 crisis in the Union. Available online at <https://eur-lex.europa.eu/legal-content/EN/TXT/?uri=CELEX:32020H1307>, checked on 3/10/2021.

European Commission (2020b): Shaping Europe's digital future. Luxembourg: Publications Office of the European Union. Available online at https://ec.europa.eu/info/sites/info/files/communication-shaping-europes-digital-future-feb2020_en_4.pdf, checked on 4/8/2021.

European Commission (2021a): Rules and requirements for energy labelling and ecodesign. Available online at https://ec.europa.eu/info/energy-climate-change-environment/standards-tools-and-labels/products-labelling-rules-and-requirements/energy-label-and-ecodesign/rules-and-requirements_en, updated on 3/8/2021, checked on 8/6/2021.

European Commission (2021b): Special Eurobarometer 510. E-Communications in the Single Market. Available online at <https://europa.eu/eurobarometer/surveys/detail/2232>, checked on 8/9/2021.

- forsa (2009): Verständlichkeit und Einflussfaktoren für verschiedene Optionen der grafischen Neugestaltung der EU-einheitlichen Energieverbrauchskennzeichnung [Understandability and influencing factors for different options for the graphical redesign of the common EU Energy Label]. dena Deutsche Energie Agentur, checked on 12/21/2015.
- Georgiadou, Vasiliki; Chenadec, Julie; Irazoqui, Cristobal (2018): D2.2 Green Data Centre Assessment Toolkit. Version 1.0. CATALYST.D2.2.GIT.WP2.v1.0 (H2020-EE-2016-2017), checked on 12/22/2020.
- GHG Protocol ICT Sector Guidance (2017): ICT Sector Guidance built on the GHG Protocol Product Life Cycle Accounting and Reporting Standard. Available online at <https://www.ghgprotocol.org/sites/default/files/ghgp/GHGP-ICTSG%20-%20ALL%20Chapters.pdf>, checked on 2/9/2021.
- Green IT Promotion Council (2012): New Data Center Energy Efficiency Evaluation Index - (DPPE) Datacenter Performance per Energy Measurement Guidelines (Ver 2.05). Available online at https://home.jeita.or.jp/greenit-pc/topics/release/pdf/dppe_e_DPPE_Measurement_Guidelines.pdf, checked on 1/20/2021.
- Green, L. W.; Kreuter, M. W. (1999): Health promotion planning. An Educational and Ecological Approach. 3rd edition. Mountain View, California.
- Gröger, Jens; Liu, Ran (2021): Green Cloud Computing. Lebenszyklusbasierte Datenerhebung zu Umweltwirkungen des Cloud Computing. With assistance of Lutz Stobbe, Jan Druschke, Nikolai Richter. Edited by Umweltbundesamt. Dessau-Roßlau. Available online at https://www.umweltbundesamt.de/sites/default/files/medien/5750/publikationen/2021-06-17_texte_94-2021_green-cloud-computing.pdf, checked on 8/10/2021.
- Grünig et al (2010): Study on Consumer Information on Fuel Economy and CO2 Emissions of New Passenger Cars. Implementation of the Directive 1999/94/EC. Available online at [https://www.europarl.europa.eu/RegData/etudes/etudes/join/2010/433455/IPOL-ENVI_ET\(2010\)433455_EN.pdf](https://www.europarl.europa.eu/RegData/etudes/etudes/join/2010/433455/IPOL-ENVI_ET(2010)433455_EN.pdf), checked on 8/6/2021.
- Hottenroth et al (2013): Carbon Footprints für Produkte. Handbuch für die betriebliche Praxis kleiner und mittlerer Unternehmen. With assistance of Heidi Hottenroth, Bettina Joa, Mario Schmidt. Hochschule Pforzheim, Institut für Industrial Ecology. Available online at https://www.hs-pforzheim.de/fileadmin/user_upload/uploads_redakteur/Forschung/INEC/Dokumente/Hottenroth_et_al_Carbon_Footprints_fuer_Produkte_web.pdf.
- Hurtado, R.; Paralera, M. (2016): Preferences of university students on the choice of internet service provider. Available online at <http://www.revistalatinacs.org/071/paper/1102/22en.html>.
- Ipsos MORI; London Economics; AEA (2012): Research on EU product label options. Final report, checked on 12/21/2015.
- ISO (2021): Environmental labels. Available online at <https://www.iso.org/publication/PUB100323.html>, updated on 8/6/2021, checked on 8/6/2021.
- ISO 14040 (2006): Environmental management - Life cycle assessment - Principles and framework.
- ITU (2008): Telecom Network Planning for evolving Network Architectures Reference Manual. Draft version 5.1; January 2008. Document NPM/5.1. International Telecommunication Union (ITU). Geneva. Available online at <https://www.itu.int/ITU->

- D/tech/NGN/Manual/Version5/NPM_V05_January2008_PART1.pdf, checked on 3/11/2021.
- ITU (2012): Review of mobile handset eco-rating schemes. Edited by International Telecommunication Union (ITU). Available online at https://www.itu.int/dms_pub/itu-t/oth/4B/01/T4B010000030001PDFE.pdf.
- ITU-T L.1315 (2017): ITU-T Rec. L.1315 (05/2017) Standardization terms and trends in energy efficiency. Edited by International Telecommunication Union (ITU, checked on 1/13/2021.
- ITU-T L.1410 (2014): ITU-T Rec. L.1410 (12/2014) Methodology for environmental life cycle assessments of information and communication technology goods, networks and services. Available online at <https://www.itu.int/rec/T-REC-L.1410-201412-I>, checked on 2/9/2021.
- ITU-T L-1302 (2015): ITU-T Rec. L.1302 (11/2015) Assessment of energy efficiency on infrastructure in data centres and telecom centres. Edited by International Telecommunication Union (ITU, checked on 1/14/2021.
- ITU-T L1310 (2020): ITU-T Rec. L.1310 (09/2020) Energy efficiency metrics and measurement methods for telecommunication equipment. Recommendation ITU-T L.1310. Edited by International Telecommunication Union (ITU. Available online at <https://www.itu.int/rec/T-REC-L.1310-202009-I/en>, checked on 1/23/2021.
- ITU-T L-1320 (2014): ITU-T Rec. L.1320 (03/2014) Energy efficiency metrics and measurement for power and cooling equipment for telecommunications and data centres. Edited by International Telecommunication Union (ITU, checked on 1/13/2021.
- ITU-T L-1470 (2020): ITU-T Rec. L.1470 (01/2020) Greenhouse gas emissions trajectories for the information and communication technology sector compatible with the UNFCCC Paris Agreement. Available online at <https://www.itu.int/rec/T-REC-L.1470-202001-I/en>, checked on 2/3/2021.
- Köhler, Andreas R.; Gröger, Jens; Liu, Ran (2018): Energie- und Ressourcenverbräuche der Digitalisierung. Expertise für das WBGU-Hauptgutachten „Unsere gemeinsame digitale Zukunft“. Available online at https://www.researchgate.net/publication/335490910_Energie-_und_Ressourcenverbrauche_der_Digitalisierung_Expertise_fur_das_WBGU-Hauptgutachten_Unsere_gemeinsame_digitale_Zukunft.
- Kollaras, Antonios; Tirabasso, Fabio (2014): Deliverable D2.1 Business scenarios and use case analysis. FP7-ICT-609140 – DOLFIN. Data Centres Optimization for Energy-Efficient and EnvironmentalLy Friendly INternet, checked on 1/17/2021.
- LEED v4.1 (2020): LEED v4.1 Building Design and Construction. Edited by U.S. Green Building Council. Available online at <https://www.usgbc.org/leed/v41>, checked on 1/5/2021.
- Levy, Moises; Raviv, Daniel (2017): A Novel Framework for Data Center Metrics using a Multidimensional Approach. 15th LACCEI International Multi-Conference for Engineering, Education, and Technology: “Global Partnerships for. Available online at http://www.laccei.org/LACCEI2017-BocaRaton/full_papers/FP387.pdf, checked on 12/28/2020.
- Liberty Global (2019): Responsible Procurement and Supply Chain Principles. Available online at <https://www.libertyglobal.com/wp-content/uploads/2019/06/Responsible-Procurement-and-Supply-Chain-Principles-2019.pdf>, checked on 3/11/2021.
- Liu, Ran; Gailhofer, Peter; Gensch, Carl-Otto; Köhler, Andreas; Wolff, Franziska (2019): Impacts of the digital transformation on the environment and sustainability. Issue

- Paper under Task 3 from the “Service contract on future EU environment policy”. Available online at https://ec.europa.eu/environment/enveco/resource_efficiency/pdf/studies/issue_paper_digital_transformation_20191220_final.pdf.
- London Economics (2014): Study on the impact of the energy label - and potential changes to it - on consumer understanding and on purchase decisions. ENER/C3/2013-428. Final Report. Ordered by the European Commission. Available online at <https://ec.europa.eu/energy/sites/ener/files/documents/Impact%20of%20energy%20labels%20on%20consumer%20behaviour.pdf>.
- London Economics; IPSOS (2014): Study on the impact of the energy label – and potential changes to it – on consumer understanding and on purchase decisions ENER/C3/2013-428 Final Report, checked on 12/21/2015.
- Lundberg, Sofia and Marklund, Per-Olov and Brännlund, Runar, Assessment of Green Public Procurement as a Policy Tool: Cost-Efficiency and Competition Considerations (May 8, 2009). Available at SSRN: <https://ssrn.com/abstract=1831089> or <http://dx.doi.org/10.2139/ssrn.1831089>
- Lykou, G.; Mentzelioti, D.; Gritzalis, D. (2017): A new methodology towards effectively assessing data center sustainability. DOI: 10.1016/j.cose.2017.12.008.
- Molenbroek, Edith; Smith, Matthew; Groenenberg, Heleen; Waide, Paul; Attali, Sophie; Fischer, Corinna et al. (2013): Evaluation of the Energy Labelling Directive and specific aspects of the Ecodesign Directive. ENER/C3/2012-523. Background report I: Literature review.
- Montevecchi, F., Stickler, T., Hintemann, R., Hinterholzer, S. (2020). Energy-efficient Cloud Computing Technologies and Policies for an Eco-friendly Cloud Market. Final Study Report on behalf of the European Commission, DG CONNECT . Vienna
- Mudgal, Shailendra; Tinetti, Benoît; Faninger, Thibault; Proske, Marina; Schischke, Karsten; Prakash, Siddharth; Liu, Ran (2013): Toward an overall measurement methodology of the carbon and energy footprints of the ICT sector. FINAL REPORT (SMART 2011/0073). Available online at <https://op.europa.eu/en/publication-detail/-/publication/9a79fd07-27af-4ad5-b39f-0fe11a49b9e5>, checked on 2/9/2021.
- Newcombe, Liam; Limbuwala, Zahl; Latham, Paul; Smith, Victor (2012): Data centre Fixed to Variable Energy Ratio metric DC-FVER. An alternative to useful work metrics which focuses operators on eliminating fixed energy consumption. Edited by BCS Data Centre Specialist Group. Available online at https://www.bcs.org/media/2917/dc_fver_metric_v10.pdf, checked on 1/12/2021.
- Newmark, Rona; Isaak, Phil; Vincent, Jay (2017): Applying ICT Capacity and Utilization Metrics to Improve Data Center Efficiency. Available online at <https://www.thegreengrid.org/en/resources/library-and-tools/443-Appling-ICT-Capacity-and-Utilization-Metrics-to-Improve-Data-Center-Efficiency>, checked on 1/20/2021.
- Omar, Emad (2019): Data Center Simulator for Sustainable Data Centers. Available online at <https://elib.uni-stuttgart.de/bitstream/11682/10604/1/Masterarbeit%20-%20Data%20Center%20Simulator%20for%20Sustainable%20Data%20Centers.pdf>, checked on 1/6/2021.
- Pärssinen, Matti (2016): Analysis and Forming of Energy Efficiency and GreenIT Metrics Framework for Sonera Helsinki Data Center HDC. Available online at <https://core.ac.uk/download/pdf/80719192.pdf>, checked on 1/6/2021.
- Patel, Chandrakant D.; Sharma, Ratnesh K.; Bash, Cullen E.; Beitelmal, Monem; (Keine Angabe) (2006): Energy Fow in the Information Technology Stack: Coefficient of

- Performance of the Ensemble and its Impact on the Total Cost of Ownership. Edited by L. P. Hewlett-Packard Development Company, checked on 12/30/2020.
- Patterson, Michael K; Poole, Stephen W; Hsu, Chung-Hsing; Maxwell, Don; Tschudi, William; Coles, Henry et al. (2013): TUE, a new energy-efficiency metric applied at ORNL's Jaguar. In International Supercomputing Conference ISC 2013, pp. 372–382. Available online at https://dcpro.lbl.gov/sites/all/files/isc13_tuepaper.pdf, checked on 12/30/2020.
- PCFCR - UPS (2020): Product Environmental Footprint Category Rules – Uninterruptible Power Supply (UPS). Version: 5.3. Available online at https://ec.europa.eu/environment/eusds/mgmp/pdf/PEFCR_UPS_Feb%202020_2.pdf, checked on 1/5/2021.
- Pehlken, Alexandra; Hintemann, Ralph; Penaherrera, Fernando; Gizli, Volkan; Hurrelmann, Karsten; Hinterholzer, Simon et al. (2019): Abschlussbericht Verbundprojekt TEMPRO. Total Energy Management for Professional Data Center Ganzheitliches Energiemanagement in professionellen Rechenzentren. Edited by Bundesministerium für Wirtschaft und Technologie, 6. Energieforschungsprogramm. Available online at https://tempro-energy.de/images/pdfs/Tempro_Endbericht_final_2020_05_14.pdf, checked on 1/6/2021.
- Peñaherrera, Fernando; Szczepaniak, Katharina (2018): Development and Application of Metrics for Evaluation of Cumulative Energy Efficiency for IT Devices in Data Centers. In Alexandra Pehlken, Matthias Kalverkamp, Rikka Wittstock (Eds.): Cascade Use in Technologies 2018. Berlin, Heidelberg: Springer Berlin Heidelberg, pp. 142–153.
- Pino, Albena (2017): The Environmental Impacts of The Environmental Impacts of Core Networks for Mobile Telecommunications: A Study Based on the Life Cycle Assessment (LCA) of Core Network Equipment. Available online at <https://pdfs.semanticscholar.org/5be6/bcba0a0b0d1d01f804bb44157b3377ff8a95.pdf>.
- Prakash, S.; Baron, Y.; Liu, R. (2014): Study on the practical application of the new framework methodology for measuring the environmental impact of ICT - cost/benefit analysis (SMART 2012/0064). With assistance of M. Proske, A. Schlösser. Available online at https://ec.europa.eu/newsroom/dae/document.cfm?doc_id=6917, checked on 3/10/2021.
- Reddy, V. Dinesh; Setz, Brian; Rao, G.S. V.R.K.; Gangadharan, G.R.; Aiello, M. (2017): Metrics for Sustainable Data Centers (VOL. 2; NO. 3). Available online at <https://ieeexplore.ieee.org/stamp/stamp.jsp?arnumber=7921551>, checked on 12/21/2020.
- Renda, A., Pelkmans, J., Egenhofer, C., Schrefler, L. Luchetta, G., Selçuki, C., Balesteros, J., Zirnelt, A. (2012) The uptake of Green Public Procurement in the EU27, study on behalf of the European Commission, DG Environment, prepared by CEPS and College of Europe, Brussels, 29th of February 2012, accessible from [CEPS-CoE-GPP MAIN REPORT.pdf \(europa.eu\)](#)
- Rivas Calvete, Silvia; Cuniberti, Barbara; Bertoldi, Paolo (2016): Effective information measures to promote energy use reduction in EU Member States. Analysis of information, empowerment and training measures in Member States National Energy Efficiency Action Plans (EUR 27997 EN). Available online at <https://publications.jrc.ec.europa.eu/repository/handle/JRC100661>, checked on 7/30/2021.
- Schödwell, Björn; Zarnekow, Rüdiger; Liu, Ran; Gröger, Jens; Wilkens, Marc (2018): Kennzahlen und Indikatoren für die Beurteilung der Ressourceneffizienz von Rechenzentren und Prüfung der praktischen Anwendbarkeit. Edited by Umweltbundesamt (Forschungskennzahl 3715 31 601 0). Available online at

- https://www.umweltbundesamt.de/sites/default/files/medien/1410/publikationen/2018-02-23_texte_19-2018_ressourceneffizienz-rechenzentren.pdf, checked on 12/30/2020.
- Shally; Sharma, Sanjay Kumar; Kumar, Sunil (2019): Measuring Energy Efficiency of Cloud Datacenters. In International Journal of Recent Technology and Engineering (IJRTE) (Volume-8 Issue-3). DOI: 10.35940/ijrte.B3548.098319.
- Shehabi, A.; Smith, S.J.; Horner, N.; Azevedo, I.; Brown, R.; Koomey, J. et al. (2016): United States Data Center Energy Usage Report. Lawrence Berkeley National Laboratory, Berkeley, California, checked on 12/24/2020.
- Smart city cluster collaboration, Task 1 (2014): Existing Data Centres energy metrics - Task 1. Edited by Seventh Framework Programme. Available online at <http://www.dolfin-fp7.eu/wp-content/uploads/2014/01/Task-1-List-of-DC-Energy-Related-Metrics-Final.pdf>, checked on 12/29/2020.
- Smart City Cluster Collaboration, Task 4 (2015): Data Centre Integration. Energy, Environmental, and Economic Efficiency Metrics: Measurement and Verification Methodology. Edited by Seventh Framework Programme.
- SNIA (2020): SNIA Emerald™ Power Efficiency Measurement Specification V4.0.0. SNIA Technical Position. Edited by SNIA Advancing storage & information technology. Available online at https://www.snia.org/tech_activities/standards/curr_standards/emerald, checked on 1/1/2021.
- SPEC (2008): SPEC Power®. Edited by Standard Performance Evaluation Corporation. Available online at https://www.spec.org/power_ssj2008/, checked on 1/14/2021.
- SPEC (2019): Server Efficiency Rating Tool (SERT) Design Document 2.0.3. Standard Performance Evaluation Corporation (SPEC®). Design Document, checked on 1/4/2021.
- Steininger et al (2017): Evaluierung des Energieausweises. Eine empirische Studie zur Wahrnehmung der Energieeffizienz von Wohnimmobilien aus der Verbraucherperspektive. Working Papers des KVF NRW 7. With assistance of Claudia Nadler, Melanie Franke, Carolin Pommeranz. Edited by Verbraucherzentrale NRW/Kompetenzzentrum Verbraucherbeforschung NRW. Düsseldorf.
- Stobbe, Lutz; Berwald, Anton (2019): State of sustainability research for network equipment. Large Network Equipment - Enterprise Switches and Routers - Final Report. Prepared for the Green Electronics Council and TÜV Rheinland in support of criteria development for the EPEAT and Green Product Mark ecolabels. Fraunhofer IZM. Berlin.
- Talens Pieró, L., Polverini, D., Ardente, F., Mathieux, F., (2020) Advances towards circular economy policies in the EU: The new Ecodesign regulation of enterprise servers, in: Resources, Conservation & Recycling, vol. 154, available at: [Advances towards circular economy policies in the EU: The new Ecodesign regulation of enterprise servers - ScienceDirect](#)
- The Green Grid (2007): Green Grid Metrics: Describing Datacenter Power Efficiency. Technical Committee White Paper, checked on 1/1/2021.
- The Green Grid (2008): A Framework for data center energy productivity. White Paper #13, checked on 1/1/2021.
- The Green Grid (2010a): ERE: A metric for measuring the benefit of reuse energy from a data center. WHITE PAPER #29. Available online at https://eehpcwg.llnl.gov/documents/infra/06_energyreuseefficiencymetric.pdf, checked on 12/29/2020.

- The Green Grid (2010b): The Green Grid Data Center Compute Efficiency Metric: DCcE. WHITE PAPER #34, checked on 1/7/2021.
- The Green Grid (2011): Water Usage Effectiveness (WUE™): A green Grid Data Center Sustainability Metric. WHITE PAPER #35, checked on 12/29/2020.
- The Green Grid (2012): Electronics Disposal Efficiency (EDE): An IT recycling metric for enterprises and data centers. WHITE PAPER #53.
- The Green Grid (2014a): Harmonizing Global Metrics for Data Center Energy Efficiency. Global Taskforce Reaches Agreement Regarding Data Center Productivity. Available online at <https://www.thegreengrid.org/en/resources/library-and-tools/215-Harmonizing-Global-Metrics-for-Data-Center-Energy-Efficiency-%E2%80%93-March-2014>, checked on 12/30/2020.
- The Green Grid (2014b): The Green Grid Data Center Storage Productivity Metrics (DCsP): Application of Storage System Productivity Operational Metrics. WHITE PAPER #58, checked on 1/1/2021.
- The Green Grid: Carbon Usage Effectiveness (CUE): A Green Grid Data Center Sustainability Metric. WHITE PAPER #32. Available online at https://www.netalis.fr/wp-content/uploads/2016/04/Carbon-Usage-Effectiveness-White-Paper_v3.pdf, checked on 12/29/2020.
- Topten Act (2018): Click your way to energy savings. TOPTEN ACT 2015-2018. Find out the most efficient products in Europe with a simple click on the Topten websites. Available online at <https://storage.topten.eu/source/files/TOPTEN-ACT-Results-Summary.pdf>.
- TÜV Rheinland and Global Electronics Council (Ed.) (2021): Criteria for the Sustainability Assessment of Network Equipment for the Global Electronics Council EPEAT® Ecolabel and the TÜV Rheinland Green Product Mark. Available online at https://globalelectronicscouncil.org/wp-content/uploads/EPEAT-Network-Equipment-Criteria_FINAL-April-2021.pdf, checked on 5/31/2021.
- UBA (2019): Marktanalyse Ökostrom II. Available online at https://www.umweltbundesamt.de/sites/default/files/medien/1410/publikationen/2019-08-15_cc_30-2019_marktanalyse_oekostrom_ii.pdf, checked on 8/6/2021.
- Vodafone (2020): Digitising Europe Pulse. Tackling Climate Change. A Survey of 13 EU Countries. Vodafone Institute for Society and Communications. Available online at https://www.vodafone-institut.de/wp-content/uploads/2020/10/VFI-DE-Pulse_Climate.pdf, checked on 3/11/2021.
- Waide, Paul; Watson, Rowan (2013): The New European Energy Label: Assessing Consumer Comprehension and Effectiveness as a Market Transformation Tool. Edited by Navigant, in collaboration with The Collaborative Labeling and Appliance Standard Program (CLASP).
- Wilde, Torsten (2018): Assessing the Energy Efficiency of High Performance Computing (HPC) Data Centers. Available online at <https://mediatum.ub.tum.de/doc/1399734/file.pdf>, checked on 1/5/2021.

Annex 1: Overview interviewed associations and companies

Name of organization	Type	Country
Data Centres		
German Data Centre Association	National Data Centre Association	Germany
European Data Centre Association	EU Trade association	EU
European Data Centre Association	EU Trade association	EU
Dutch Data Centre Association	National Trade association	The Netherlands
Dutch Data Centre Association	National Trade association	The Netherlands
Datacenter Industrien	National Trade Association	Denmark
Gimelec	National Trade Association filère électronique France	France
EATON	Company	France
France Datacenter	National Trade Association	France
France Datacenter	National Trade Association	France
BITKOM	National Trade Association	Germany
Uptime Institute	Data Center Authority	Worldwide
Electronic Communications Services and Networks		
Deutsche Telekom	Company	Germany
European Telecommunications Network Operators' Association (ETNO)	EU Trade association	EU
FTTH Council	EU Trade association	EU
GigaEurope	EU Trade association	EU
Huawei	Company	Worldwide
Liberty Global	Company	Belgium
Telefonica	Company	Spain
Telia Company	Company	Sweden
Vodafone	Company	Worldwide

Annex 2: Distribution reports of the surveys

Survey for data centre owners and operators

Start date	End date	Start page views	Respondents	Screened out	Partial completes	Reached end
09-02-2021	01-04-2021	473	87 (18% of start page views)	28	49	10

Survey for communications network operators, service providers and network equipment suppliers

Start date	End date	Start page views	Respondents	Screened out	Partial completes	Reached end
24-02-2021	31-03-2021	129	25 (19% of start page views)	0	9	16

Survey about consumer perspectives on potential indicators for ECNs

Start date	End date	Start page views	Respondents	Screened out	Partial completes	Reached end
24-05-2021	26-06-2021	46	12 (26% of start page views)	0	2	10

The following consumer organisations completed the questionnaire for the survey about consumer perspectives on potential indicators for ECNs:

- ASUFIN
- Austrian Chamber of Labour
- Consumentenbond
- Consumers Organisation of Macedonia
- Danish Consumer Council
- DECO – Associação Portuguesa para a Defesa do Consumidor
- ECOS

- KEPKA - Consumers' Protection Center
- Stiftung Warentest
- ZPS - Zveza potrošnikov Slovenije (Slovene Consumers' Association)

The following countries are covered by these organisations:

- Austria
- Belgium
- Denmark
- Germany
- Greece
- Lithuania
- Netherlands
- North Macedonia
- Portugal
- Slovenia
- Spain

Annex 3: Interview questions for Data Centre Associations related to Tasks 1.1.1., 1.1.2. and 1.1.3. (version 19-01-2021)

Questions were prioritised to maximise response and input in case of time limitations from the respondents: (!!) question with very high priority, (!) question with high priority.

Definition of data centres (T1.1.1.)

- (!!) There is a well-known broad definition of data centres (*Structure, or group of structures, dedicated to the centralized accommodation, interconnection and operation of information technology and network telecommunications equipment providing data storage, processing and transport services together with all the facilities and infrastructures for power distribution and environmental control together with the necessary levels of resilience and security required to provide the desired service availability.*) But during our desk research we observed that various criteria are used to further refine this definition allowing for a categorisation of data centres. Criteria are often based on: size (physical area, number of servers/workload capacity), physical location, security level (cf. Uptime), business model, etc.
 - How would you define a small, large or hyperscale data centre?
 - What criteria do you use in your organisation to distinguish data centres and why?
 - What specific thresholds do you use?
 - Which additional criteria are relevant (or do you know) to distinguish data centres?

The data centre / data centre service provider market (T.1.1.1.)

- (!!) What are, according to you, the three most important trends that you observe in the data centre sector?
 - Do these trends apply to all types? (Could you indicate whether certain trends only apply in some types of data centres)?
- (!) Who are the most important end-users of data centres (private companies, public organisations, knowledge institutions)?
- (!) We want to estimate the market size of data centres (number of data centres, data centre providers, operators) depending on different definitions. Are you aware of any extensive datasets on data centres / data centre service providers (containing number of data centres, size indicators such as floor size/number of servers, business model, etc., contact details)? For <region> or the EU market as a whole? Are these publicly available?
 - Did you already perform such an exercise yourselves? Are the results publicly available?
 - What are your future expectations on economic indicators such as employment, turnover, investments and number of users related to data centres? (higher, stable, low)?

Methodologies and costs related to energy and environmental management

- (!!) Which indicators are used to measure energy efficiency and environmental impacts? (e.g. PUE, Carbon Footprint, SERT2, SNIA Emerald, certain standards)
- (!!) Which performance indicators are used to measure the useful work of data centres (e.g. server operations, server utilization, storage space, storage utilization, bandwidth, network utilization)
- (!) What environmental information and standards (e.g. eco-labels) are requested by data centre clients?
- What efforts are being made in data centres to enable energy monitoring and sustainability reporting?
 - Can you give an estimate of how much investment (e.g. for special measurement technology) and personnel costs are used for this (preferably as a percentage of total turnover)?
- What is the proportion of the investment costs of the energy measurement devices in comparison to the total investment costs of the hardware (approximately)?
 - Which energy and temperature measuring devices are used for the energy management of data centres?
- What is the share of personnel costs for energy and environmental management in the total personnel costs (approximately)?
- (!) Are there among your members organisations that are frontrunners in the field of energy management and pursuing low environmental impact?

Circularity practices: (T1.1.2)

- (!!) To which degree is circularity of data centre equipment a concern for data centres?
 - If so, what actions do data centres undertake in order to increase circular practices?
 - (Actions related to maintenance, reuse, refurbishment, remanufacturing as well as secondary markets for data centre components and materials)
 - What kind of data centre equipment? (data cabinets, servers, e-waste)
- (!) Do you have an indication of the percentage of data centre hardware that is being recycled and/or reused?
- (!) Do you have an indication of the percentage of recycled e-waste material that is used for the manufacturing of new data centre hardware?
- What are the the most important secondary markets for data centre components and materials?
- What metrics are currently used to measure circularity?
 - Are these metrics being reported? If so, is this information publicly available?
- To what extent do you refer to the Environmental Footprint method for assessing Data Centres' footprint in your network?¹⁸³
- (!!) What would need to happen in order for data centres to extend their hardware's useful life? E.g. related to policy, competition, technology.

¹⁸³ <https://eplca.jrc.ec.europa.eu/EnvironmentalFootprint.html>

- Policy;
- Competition;
- Technology.
- (!!) Is the treatment/disposal of data centre hardware after decommissioning currently of great concern ? If so, in which way ?
- (!) Are there among your members organisations that are frontrunners in the field circular economy practices and if so, who are they?

General questions

- (!) Which information sources and literature do you find helpful to get an insight in the outlook for the data centres for the coming years?
- (!!) Would you be willing to promote our survey, which we plan to launch early February 2021, among your members?
- Could we contact you again during the course of our study to be involved in an impact analysis of various policy instruments related to making data centres greener?

Annex 4: Questions for survey to electronic communications network operators, service providers and network equipment suppliers related to Task 1.2.1 and Task 1.2.2 (version 23-02-2021)

Company information

1. What is the name of your organisation?

2. What are the business areas of your company? (Multiple selections possible)
 - a) Operator of electronic communication networks
 - b) Network equipment supplier
 - c) Electronic communications service provider (telephone, internet, television)
 - d) Organisation representing operators of electronic communications networks
 - e) Other, please specify

3. Please name the countries in which your company operates

Environmental reporting

4. How does your company report on its environmental policies and impacts? (Multiple selections possible)
 - a) With an annual report (e.g. Corporate Social Responsibility report)
 - b) As a sub-section of an annual corporate report
 - c) Publication of key figures on the company website
 - d) Direct customer information within invoices or customer accounts
 - e) Other, please specify
 - f) Not at all

5. Please briefly explain what objective your company is pursuing through this reporting and why the reporting formats mentioned above have been chosen.

6. Which areas of the company's activities are included in this reporting? (Multiple selections possible)
 - a) Direct environmental impacts
 - b) Environmental impacts from upstream value chains (e.g. energy, equipment, etc.)

- c) Environmental impacts from downstream value chains (e.g. energy consumption or electronic waste at customers)
- d) Other, please specify
- e) None

7. Please briefly describe why these areas were chosen for reporting.

Environmental indicators and standards

8. Which indicators do you use for environmental reporting? If possible, please state the exact name of the metrics/standards used. (Multiple selections possible)

- a) Energy consumption
- b) CO₂ equivalent
- c) Material consumption
- d) Water consumption
- e) E-Waste Management
- f) Use of renewable energies (e.g. electr., fuel)
- g) Use of renewable raw materials
- h) Energy intensity of communication networks
- i) Other
- j) None

9. What standards do you use for company-wide reporting? (Multiple selections possible)

- a) Greenhouse Gas (GHG) Protocol
- b) Global Reporting Initiative (GRI) Standards
- c) Energy management system based on ISO 50 001
- d) Reporting of greenhouse gas emissions based on ISO 14064
- e) OEF (Organisation Environmental Footprint)
(https://ec.europa.eu/environment/eussd/smgp/dev_methods.htm)
- f) International Telecommunication Union (ITU) (e.g. ITU-T L.1332)
- g) European Telecommunications Standards Institute (ETSI) (e.g. ETSI ES 203 475)
- h) Environmental management according to ISO 14001
- i) Eco-Management and Audit Scheme (EMAS)
- j) Life Cycle Assessment (LCA) based on ISO 14040/44
- k) Other, please name the standard used
- l) None

10. Please describe why you have chosen these standards.

11. Is there a further need for environmental reporting standards for electronic communication networks that still need to be developed? What should these standards cover?

The following questions are addressed to the providers of electronic communications services (irrespective of whether they also operate a network)

12. Which electronic communications services do you mainly offer? (Multiple selections possible)
- a) Mobile services (voice, internet, messaging)
 - b) Fixed voice communications (telephony)
 - c) Fixed broadband internet access
 - d) Fixed TV
 - e) Other, please specify
 - f) None

13. What key-figures does your company communicate to consumers (e.g. advertising, product data sheets) when reporting the environmental performance of communications services? (Multiple selections possible)
- a) Product Environmental Footprint (PEF)
(<https://eplca.jrc.ec.europa.eu/EnvironmentalFootprint.html>)
 - b) Energy intensity of the communication network (e.g. [kWh/Gbyte])
 - c) Energy consumption or greenhouse gas emissions per customer (e.g. CO₂-eq/subscriber)
 - d) Energy consumption or greenhouse gas emissions per service unit (e.g. CO₂-eq/hour video streaming)
 - e) Energy consumption of the router or other network equipment in the customer's property
 - f) Other, please specify
 - g) None

14. Do you know of any methodologies beyond those mentioned above that could be suitable for capturing the specific environmental impacts of electronic communications services?

Procurement of network equipment / Offering network equipment

The following questions are addressed to the operators of electronic communications networks and the suppliers of network equipment

15. Network operators: What requirements do you expect suppliers to meet when you procure new network equipment? Network equipment suppliers: What are your requirements when you offer network components? (Multiple selections possible)

- a) Requirements according to EU Code of Conduct on Energy Consumption of Broadband Equipment
- b) Other energy consumption requirements (e.g. W/port in different operation states)
- c) Contractual guarantees for the minimum energy efficiency
- d) Requirements for the environmental and sustainable production
- e) Guarantees to provide spare parts and software updates over the expected useful life
- f) Taking back old or defective components for refurbishment
- g) None of the above

16. Please list the most important environmental requirements in purchasing/sales of network equipment that go beyond the above:

General assessment of appropriate approaches

17. How could end-users be encouraged to choose and use climate-friendly and resource-saving electronic communications services?

18. How could electronic communications providers contribute to the European Green Deal to achieve climate neutrality in 2050?

Annex 5: Questions for survey about consumer perspectives on potential indicators for environmental footprint of electronic communications services related to Task 1.2.4 (version 17-05-2021)

Overall objective: Reduction of the environmental footprint of electronic communications networks and services.

Sub-goal: Motivate consumers to choose an energy-efficient electronic communications provider and reduce the environmental footprint of service use.

- 1. What is the name of your organisation?**

- 2. Please name the country in which your organisation operates**
 - Austria, Belgium, Bulgaria, Croatia, Cyprus, Czech Republic, Denmark, Estonia, Finland, France, Germany, Greece, Hungary, Iceland, Ireland, Italy, Latvia, Lithuania, Luxembourg, Malta, Netherlands, North Macedonia, Norway, Poland, Portugal, Romania, Slovakia, Slovenia, Spain, Sweden, Switzerland, United Kingdom.

- 3. Has your organisation been involved in consumer information / tests on electronic communications services in the past?**
 - yes
 - no
 - don't know

- 4. Do you consider information to consumers on the environmental footprint of electronic communications services to be an effective way for achieving a reduction in the energy consumption of the electronic communications services?**
 - Very well suited (++), well suited (+), less well suited (-), not suited at all (--)
 - Please specify why:

- 5. In your opinion, what is the role of the following aspects in consumers' decision to choose a particular electronic communications service (e.g. mobile operator or internet service provider (ISP))?**
 - Reliability (no service disruptions) (++ | + | - | --)
 - Speed (data transfer rates) (++ | + | - | --)
 - Energy efficiency (++ | + | - | --)
 - Price (and other commercial aspects) (++ | + | - | --)
 - Others, please specify:

6. To which level should the information on environmental impacts refer?

- To the provider/company level (e.g. average values across all customers)
- To the level of the specific service (e.g. internet access via fibre, mobile access via 4G)
- Others, please specify:

7. How understandable do you think the following environmental indicators on electronic communication services are for consumers?

- Annual energy consumption of the provider per subscriber [kWh/(a*subscriber)]
(++ | + | - | --)
- Energy intensity of data transmission [Wh/GByte] (++) | + | - | --)
- Power consumption of the network per subscriber [W/subscriber] (++) | + | - | -)
- Annual carbon footprint per subscriber [kg CO₂-eq/(a*subscriber)] (++) | + | - | --)
- Specific carbon footprint of data transmission [g CO₂-eq/GByte] (++) | + | - | -)
- Share of renewable energies of the network operator in total energy consumption [%]
(++) | + | - | --)
- Others, please specify:

8. Where should such information on the environmental indicators of communications services be provided?

- Website of the service provider (++) | + | - | --)
- Advertising of the respective service (++) | + | - | --)
- Product data bases (++) | + | - | --)
- Invoice (e.g. monthly telephone bill) (++) | + | - | --)
- Others, please specify:

9. Imagine that the energy efficiency of a fixed internet or mobile service is displayed to consumers together with the offers and tariffs of the provider. This could be done with a colour-scale, for example:

Energy colour scale	efficiency	E.g. Power consumption of the service per subscriber	E.g. Energy intensity of data transmission	E.g. Carbon footprint of data transmission
		< 1 Watt	< 1 Wh/GByte	< 1 g CO ₂ -eq/GByte
		< 2 Watt	< 2 Wh/GByte	< 2 g CO ₂ -eq/GByte
		< 4 Watt	< 4 Wh/GByte	< 4 g CO ₂ -eq/GByte
		< 8 Watt	< 8 Wh/GByte	< 8 g CO ₂ -eq/GByte
		< 16 Watt	< 16 Wh/GByte	< 16 g CO ₂ -eq/GByte
		< 32 Watt	< 32 Wh/GByte	< 32 g CO ₂ -eq/GByte
		≥ 32Watt	≥ 32 Wh/GByte	≥ 32 g CO ₂ -eq/GByte

Do you think this information would help consumers to take energy efficiency into account when deciding on a specific service?

- Very well suited, (++) , well suited, (+) , less well suited, (-) , not suited at all (--)
- Please specify:

10. What additional information or measures could enhance the effect of such colour coding?

- Declaration of CO₂-eq-emissions (++ | + | - | --)
- Declaration of reference values (e.g. with reference to the efficiency of best available technology) (++ | + | - | --)
- Prominent display of the colour coding in tariff offers (++ | + | - | --)
- Information campaign on energy efficiency (++ | + | - | --)
- Others, please specify (++ | + | - | --)

11. Do you see potential disadvantages or risks for consumers if information on environmental footprint of services is introduced?

- Consumer confusion: very applicable, applicable, less applicable, not applicable at all
- Greenwashing: very applicable, applicable, less applicable, not applicable at all
- Too little effect: very applicable, applicable, less applicable, not applicable at all
- Others, please specify:

12. Which instruments do you think could be most suitable to improve the environmental footprint of communication services?

- Ecodesign type of requirements (efficiency requirements) (++) | + | - | --)
- Energy label type of requirement (information requirements) (++) | + | - | --)
- Ecolabel type of requirement (front-runner communication) (++) | + | - | --)
- Electronic product passport (EPREL database) (++) | + | - | --)
- Voluntary agreement of providers on information requirements (++) | + | - | --)
- Voluntary agreement of providers on efficiency requirements (++) | + | - | --)
- Others, please specify: (++) | + | - | --)

13. What would be your suggestion to move forward to more sustainable communication services?

- please specify:

14. Do you have any other comments you would like to share for this study?

- please specify:

Annex 6: Task 1.1.3 Methods for measuring energy and resource efficiency of data centres

Here we give a detailed overview of the main features of existing metrics used by data centre operators:

- Name of metrics and abbreviation: describing full names and their corresponding acronyms
- Scope in terms of life stages covered: taking into account production, operation, end-of-life, or the whole life cycle
- Scope in terms of targeted environmental aspects: documenting power / energy, natural resource, water, waste and environmental impact etc.
- Scope in terms of field of application: clarifying the system or specific equipment covered
- Description: briefly explaining the purposes
- Computational formula: expressing the mathematical formulation. The symbols used in the formulas have been avoided, instead an explanation is used to make it reader-friendly
- Source: describing the references.

Annex 6.1: Overview of metrics of environmental performance

Table 46: Overview of metrics in terms of power and energy, sorted by the field of application

No.	Name of metrics	acronym	Scope: Life stages covered	Scope: targeted environmental aspects	Scope: Field of application	Description	Computational formula	Source
1	Power usage effectiveness (PUE); Partial PUE (pPUE); Designed PUE (dPUE); Interim PUE (iPUE); PUE ₁₋₃	PUE	operation	energy (secondary energy)	infrastructure	measurement of infrastructure energy efficiency in DCs	$PUE = \frac{\text{Total DC annual power/energy}}{\text{Total IT Annual power/energy}}$	<ul style="list-style-type: none"> ▶ EN 50600-4-2 ▶ ISO/IEC 30134-2

No.	Name of metrics	acronym	Scope: Life stages covered	Scope: targeted environmental aspects	Scope: Field of application	Description	Computational formula	Source
2	Data centre infrastructure efficiency	DCiE	operation	energy (secondary energy)	infrastructure		$DCiE = \frac{1}{PUE}$	(Alger 2010; Schödwell et al. 2018)
3	Facility Energy Efficiency	FEE	operation	energy (secondary energy)	infrastructure	the ratio of IT load to total power	$FEE = DCiE$	(Alger 2010) (Schödwell et al. 2018)
4	Site Infrastructure Energy Efficiency ratio (SI-EER)	SI-EER	operation	energy (secondary energy)	infrastructure	Efficiency of DC's infrastructure systems	$SI - EER = PUE$	Uptime institute (Brill 2007)
5	Global Key Performance Indicator of Task Efficiency	KPI _{TE}	operation	energy (secondary energy)	infrastructure	Efficiency of DC's infrastructure systems	KPI_{TE} $= \frac{\text{Total Energy consumption by a DC over a year}}{\text{total energy consumptin by equipment processing data}} = PUE$	(Kollaras and Tirabasso 2014; ETSI ES 205 200-2-1 2014)
6	IT-Power Usage Effectiveness (ITUE)	ITUE	operation	energy (secondary energy)	IT equipment	defined as total IT energy divided by computational energy (e.g. CPU, memory, and storage)	$ITUE$ $= \frac{\text{Total Energy into the IT Equipment}}{\text{Total energy into the compute components}}$	(Patterson et al. 2013)

No.	Name of metrics	acronym	Scope: Life stages covered	Scope: targeted environmental aspects	Scope: Field of application	Description	Computational formula	Source
7	Renewable energy factor (REF)	REF	operation	energy (secondary energy)	DC facility	the percentage of a renewable energy over total DC energy	$REF = \frac{\text{Renewable Energy owned and controlled by DCs}}{\text{Total DC annual energy}}$	► EN 50600-4-3: ► ISO/IEC 30134-3:2016
8	Green Energy Coefficient (GEC)	GEC	operation	energy (secondary energy)	DC facility	The share of renewable / green energy.	$GEC = \frac{\text{Green Energy used by DC}}{\text{Total DC energy}}$	(The Green Grid 2014a)
9	Total power Usage Effectiveness (TUE)	TUE	operation	energy (secondary energy)	DC facility	the total energy into the DC divided by the total energy to the computational components inside the IT equipment.	$TUE = \frac{\text{Total DC Energy}}{\text{Total energy into the compute componetns}}$ $= ITUE \times PUE$	(Patterson et al. 2013)
10	ITU-T L-1302: Assessment of energy efficiency on infrastructure in data centres and telecom centres	PUE; PLF; CLF	operation	energy (secondary energy)	Building infrastructure; Power feeding system	<p>The CLF: the total power consumed by whole cooling system divided by the IT Load.</p> <p>The PLF: the total power dissipated by the power feeding system (e.g. UPSs, PDUs) divided by the IT loads.</p>	Building infrastructure: PUE, pPUE (partial PUE) Power feeding system: PLF (power load factor) = $\frac{\text{Energy}_{input_power} - \text{Energy}_{IT}}{\text{Energy}_{IT}}$ Cooling equipment: CLF (cooling load factor) = $\frac{\text{Energy}_{whole\ cooling\ system}}{\text{Energy}_{IT}}$	(ITU-T L-1302 2015)

No.	Name of metrics	acronym	Scope: Life stages covered	Scope: targeted environmental aspects	Scope: Field of application	Description	Computational formula	Source
11	ITU-T L-1320: Energy efficiency metrics and measurement for power and cooling equipment	EE ratio	operation	energy (secondary energy)	Power feeding equipment and cooling equipment	Energy efficiency metrics and measurement	$\eta = \frac{\text{Output power (w)}}{\text{input power (w)}}$	(ITU-T L-1320 2014)
12	Cooling Efficiency Ratio (CER)	CER	operation	energy (secondary energy)	Cooling system	cooling energy	Under development	► EN 50600-4-7; ► ISO/IEC 30134-7
13	coefficient of performance (COP)	COP	operation	energy (secondary energy)	Cooling system	The ratio of total heat load (e.g. power delivered to IT equipment) to the power consumed by the cooling infrastructure	$COP = \frac{\text{Total Heat Dissipation (Flow Work+Thermodynamic Work) of cooling system}}{\text{Heat extracted by air conditioners Net Work Input}}$	(Patel et al. 2006)
14	Energy Efficiency / Efficient Ratio (EER); Seasonal EER (SEER)	EER	operation	energy (secondary energy)	Cooling system	the total heat removed from the conditioned space (during the annual cooling season), divided by the total electrical energy consumed by the air conditioner or heat	$EER = \frac{\text{Heat removed by the cooling system}}{\text{Electrical power used by the cooling system}}$	(Smart city cluster collaboration, Task 1 2014)

No.	Name of metrics	acronym	Scope: Life stages covered	Scope: targeted environmental aspects	Scope: Field of application	Description	Computational formula	Source
						pump (during the same season)		
15	ENERGY STAR® for UPSs version 2.0 (adopted by PCFCR ¹⁸⁴ UPS v5.3)	-	operation	energy (secondary energy)	UPS ¹⁸⁵	metrics for energy efficiency are used for the use stage	Loading-adjusted energy efficiency calculation of a single mode UPS and a multimode UPS	(PCFCR - UPS 2020)
16	Adaptability Power Curve	APC	operation	energy (secondary energy)	DC Flexibility: Energy Shifting	an evaluation of the capability of a DC to adapt to a pre-defined DC energy consumption curve.	$APC = 1 - \frac{\sum_{i=1}^n DC\ Energy\ consumption - K_{APC} \times Planned\ Energy }{\sum_{i=1}^n DC\ Energy\ consumption}$ $K_{APC}: \text{Correlative factor} = \frac{\sum_{i=1}^n DC\ Energy\ consumption}{\sum_{i=1}^n planned\ energy}$	(Smart City Cluster Collaboration, Task 4 2015)
17	Adaptability Power Curve at Renewable Energies	APC _{ren}	operation	energy (secondary energy)	DC Flexibility: Energy Shifting	an evaluation of the capability of a DC to adapt to the production curve of the renewable	$APC = 1 - \frac{\sum_{i=1}^n K_{APCren} \times Renewable\ Energy\ production - DC\ Energy\ consumption }{\sum_{i=1}^n DC\ Energy\ consumption}$ $K_{APCren}: \text{Correlative factor} =$	(Smart City Cluster Collaboration, Task 4 2015)

¹⁸⁴ PEF is a Life cycle based method

¹⁸⁵ EU Code of Conduct for AC Uninterruptible Power Systems is not considered, since the version 2.0 refers to 2011-2014 and is not further updated <https://ec.europa.eu/jrc/en/energy-efficiency/code-conduct/ups>

No.	Name of metrics	acronym	Scope: Life stages covered	Scope: targeted environmental aspects	Scope: Field of application	Description	Computational formula	Source
						energy sources available to the DC in hand	$\frac{\sum_{i=1}^n DC \text{ Energy consumption}}{\sum_{i=1}^n \text{renewable energy production}}$	
18	Data Centre Adapt	DCA	operation	energy (secondary energy)	DC Flexibility: Energy Shifting	an evaluation of the capability of a DC to change its energy consumption behaviour, compared to its respective behaviour before the application of a certain set of optimisation actions	$DCA = 1 - \frac{\sum_{i=1}^n \left \frac{K_{DCA} \times DC's \text{ real energy consumption} - DC's \text{ baseline Energy consumption}}{\sum_{i=1}^n DC's \text{ baseline Energy consumption}} \right }{\sum_{i=1}^n DC's \text{ baseline energy consumption}}$ <p>K_{DCA}: scaling factor=</p> $\frac{\sum_{i=1}^n DC's \text{ baseline energy consumption}}{\sum_{i=1}^n DC's \text{ real energy consumption}}$	(Smart City Cluster Collaboration, Task 4 2015)
19	Global Key Performance Indicator of energy management	KPI _{EM}	operation	energy (secondary energy)	DC facility		$KPI_{EM} = KPI_{EC} \times KPI_{TE} \times (1 - (KPI_{REN} \times W_{REN})) \times (1 - (KPI_{REUSE} \times W_{REUSE}))$ <p>KPI_{EC}: energy consumption</p> <p>KPI_{TE}: task efficiency</p> <p>KPI_{REN}: renewable energy use</p> <p>KPI_{Reuse}: energy re-use</p> <p>W: weighting factor</p>	(ETSI ES 205 200-2-1 2014)

Source: Oeko-Institut

Table 47: Overview of metrics in terms of natural resource

No.	Name of metrics	acronym	Scope: Life stages covered	Scope: targeted environmental aspects	Scope: Field of application	Description	Computational formula	Source
1	Green Material Use (GMU)	GMU	operation	Resource (materials, raw materials)	DC facility	Share of green products (e.g. recycled goods) to total annual purchases	$GMU = \frac{\text{Green Product Purchases}}{\text{Total Annual Purchases}}$	(Lykou et al. 2017)

Source: Oeko-Institut

Table 48: Overview of metrics in terms of water

No.	Name of metrics	acronym	Scope: Life stages covered	Scope: targeted environmental aspects	Scope: Field of application	Description	Computational formula	Source
1	Water Usage Effectiveness (site)	WUE_{site}	operation	Water	DC facility	a site-based metric that is an assessment of the water used on-site for operation of DCs.	$WUE_{site} = \frac{\text{Annual Site Water Usage}}{\text{IT Equipment Energy}}$	<ul style="list-style-type: none"> ▶ EN 50600-4-9; ▶ ISO/IEC 30134-9; (The Green Grid 2011)
2	Water Usage Effectiveness (source)	WUE_{source}	operation + upstream process of	water	DC facility	a source-based metric that includes water used on-site and	$WUE_{source} = \frac{\text{Annual Source Energy Water Usage} + \text{Annual Site Water Usage}}{\text{IT Equipment Energy}}$	(The Green Grid 2011)

			electricity generation			water used off-site in the production of the energy used on-site.	$= WUE_{site} + \frac{\text{Annual Source Energy Water Usage}}{\text{IT Equipment Energy}}$	
--	--	--	------------------------	--	--	---	---	--

Source: Oeko-Institut

Table 49: Overview of metrics in terms of wastes (e.g. e-waste, waste heat), sorted by the field of application

No	Name of metrics	acronym	Scope: Life stages covered	Scope: targeted environmental aspects	Scope: Field of application	Description	Computational formula	Source
1	Energy reuse effectiveness (ERE)	ERE	operation	energy (secondary energy)	DC facility	measuring the benefit of reuse energy	$ERE = (1 - ERF) \times PUE$ $= \frac{\text{Cooling} + \text{Power} + \text{Lighting} + \text{IT} - \text{Reuse}}{\text{IT}}$	(The Green Grid 2010a)
2	Energy Reuse Factor (ERF)	ERF	operation	energy (secondary energy)	DC facility	energy from the DC (annual) that is used outside of the DC and which substitutes partly or totally energy needed outside the DC boundary (annual)	$ERF = \frac{\text{Energy}_{\text{reuse outside of DC}}}{\text{Total DC Energy}}$	► EN 50600-4-6; ► ISO/IEC 30134-6; ► (The Green Grid 2010a)
3	In-house Reuse	IRF	operation	energy (secondary energy)	DC facility	the ratio of recovered energy over the total DC energy consumption	$IRF = \frac{\text{Energy recovered within DC}}{\text{Total DC Energy}}$	research study: CATALYST Toolkit

	Factor (IRF)							(Georgiadou et al. 2018)
4	Sustainable Heat Exploitation (SHE)	SHE	operation	energy (secondary energy)	DC facility	an indicator related to the efficiency of the waste heat recovering equipment. It reflects the increase (worsening) in the energy demand of the DC in order to enable residual heat reuse in comparison to a baseline scenario where the heat is not exploited (before residual heat recovery)	$SHE = \frac{\text{electricity feeding the heat recovery system}}{\text{Total DC Energy (before waste heat recovery)}}$	research study: CATALYST Toolkit (Georgiadou et al. 2018)
5	Heat Usage Effectiveness	HUE	operation	energy (secondary energy)	DC facility	Effectiveness of heat recovered	$HUE = \frac{\text{Heat recovered}}{SHE}$	research study: CATALYST Toolkit (Georgiadou et al. 2018)
6	Electronics Disposal Efficiency (EDE)	EDE	end-of-life	e-waste disposal	IT and telecommunications equipment	-to increase industry awareness regarding the responsible disposal of IT assets. -not as an instrument to compare itself with others	$EDE = \frac{\text{Weight}^{\text{Responsibly Disposed}}}{\text{Total Weight}^{\text{Disposed}}}$	(The Green Grid 2012)

Source: Oeko-Institut

Table 50: Overview of metrics in terms of environmental impacts (in this case: CO₂-eq), sorted by the field of application

No.	Name of metrics	acronym	Scope: Life stages covered	Scope: targeted environmental aspects	Scope: Field of application	Description	Computational formula	Source
1	Carbon Usage Effectiveness (CUE)	CUE	operation	CO ₂ -eq emissions	DC facility	CO ₂ -eq associated with energy consumption in DCs	$CUE = \frac{\text{Total CO}_2 \text{ caused by the total DC Energy}}{\text{IT Equipment Energy}} = PUE \times CEF (\text{carbon emission factor})$	<ul style="list-style-type: none"> ▶ EN 50600-4-8; ▶ ISO/IEC 30134-8; ▶ (The Green Grid)
2	Technology Carbon Efficiency (TCE)	TCE=CUE	operation	CO ₂ -eq emissions	DC facility	Combining that emissions factor with energy consumption	$TCE = \frac{\text{Total Facility Power}}{\text{IT Equipment Power}} \times \text{Electricity carbon emission} = PUE \times CEF (\text{carbon emission factor})$	(Alger 2010) was introduced in 2007 by CS Technology
3	ENERGY STAR Score for DC	ENERGY STAR Score	operation + upstream process of electricity generation	energy (primary energy)	DC facility	identify the score from the lookup table using the energy efficiency ratio	$\text{Energy Efficiency Ratio} = \frac{\text{Actual PUE}}{\text{Predicted PUE}}$	(Energy Star 2018)
4	Primary Energy (PE) Savings	PE Savings	operation + upstream process of electricity generation	energy savings (primary energy)	DC facility	The percentage of savings in terms of primary energy consumed by a DC, once improvements	$PE \text{ Savings} = \left(1 - \frac{\text{total PE measured}}{\text{total PE that would have been consumed}} \right) \times 100$	(Smart City Cluster Collaboration, Task 4 2015)

No.	Name of metrics	acronym	Scope: Life stages covered	Scope: targeted environmental aspects	Scope: Field of application	Description	Computational formula	Source
						have taken place		
5	CO ₂ Avoided Emissions	CO ₂ Savings	operation	CO ₂ -eq avoided emissions	DC facility	The percentage of savings in terms of CO ₂ emissions generated by a data centre, once improvements have taken place	$CO_2 \text{ Savings} = \left(1 - \frac{\text{total CO}_2 \text{ emissions released}}{\text{the total CO}_2 \text{ emissions that would have been released}}\right) \times 100$	(Smart City Cluster Collaboration, Task 4 2015)

Source: Oeko-Institut

Annex 6.2: Overview of metrics in terms of environmental performance and general IT-performance metrics combined

Table 51: Relevant general IT- performance metrics

No	Name of metrics	acronym	Scope: Life stages covered	Scope: targeted environmental aspects	Scope: Field of application	Description	Computational formula	Source
1	IT Equipment Utilization for servers (ITEUsv)	ITEUsv	operation	Utilization	servers	describes the utilization of the server equipment in the data centre in operational conditions.	$ITEU_{sv}(t) = \frac{\sum_{i=1}^n \text{the CPU utilization ratio of server } i \text{ at time } t (\%)}{\text{the number of servers in a DC or in a group running at time } t}$	ITEUsv: ISO/IEC 30134-5:2017
2	IT Equipment Utilization (ITEU)	ITEU	operation	Utilization	IT equipment	Describes how effectively the capability of IT devices is used	$ITEU = \frac{\text{total measured energy consumption of IT equipment}}{\text{total rated energy consumption of IT equipment}}$	(Green IT Promotion Council 2012)
3	DC Compute Efficiency	DCcE	operation	compute resources (number of servers providing a primary service)	servers	enable DC operators to determine the efficiency of their compute resources, which allows them to identify areas of inefficiency	$\text{Server compute efficiency (ScE)} = \frac{\text{Number of samples where server provides a primary service}}{\text{total number of samples}} \times 100$ $DCcE = \frac{\text{total ScE Values from all servers}}{\text{total number of all servers in DC}}$	(The Green Grid 2010b)
4	Compute Utilization	CPU _u	operation	Utilization	servers	Average CPU utilization of servers in DC by CPU capacity and the measurement of current utilization	$CPU_u = \frac{\sum \text{Measured utilization}_i}{\sum \text{ClockSpeed}_i \times \text{number of Cores}_i}$	(Newmark et al. 2017)

5	Memory Utilization	MEM _u	operation	Utilization	servers	Average memory utilization of servers in DC by capacity and used memory capacity	$MEM_u = \frac{\sum \text{Measured utilization of the DIMMs}_i}{\sum \text{Sum of DIMMs}_i}$	(Newmark et al. 2017)
6	Storage Utilization	STOR _u	operation	Utilization	storage	Average memory utilization of servers in DC by total addressable capacity and storage in use	$STOR_u = \frac{\sum \text{all capacity in use}_i}{\sum \text{Sum of addressable capacity}_i}$	(Newmark et al. 2017)
7	Network Utilization	NET _u	operation	Utilization	network	Average Network Utilization at the edge and access tier.	$NET_u = \frac{\sum \text{measured actual bandwidth consumed}}{\text{Network capacity}}$ $\text{Network capacity} = \sum \text{bandwidth into and out of DC} + \sum \text{bandwidth between devices and network aggregate}$	(Newmark et al. 2017)

Source: Oeko-Institut

Table 52: Overview of metrics in terms of environmental performance and general IT-performance metrics combined

No	Name of metrics	acronym	Scope: Life stages covered	Scope: targeted environmental aspects	Scope: Field of application	Description	Computational formula	Source
----	-----------------	---------	----------------------------	---------------------------------------	-----------------------------	-------------	-----------------------	--------

1	Facility Efficiency	FE	operation	energy (secondary energy)	DC facility	efficiency of the facility	$FE = FU \text{ (Facility Utilization)} \times FEE \text{ (Facility Energy Efficiency)}$ $= FU \times DCiE = \frac{FU}{PUE}$ <p>Facility Utilization (FU)=Data Centre Utilization (U_{DC})= $\frac{\text{actual IT equipment power in use}}{\text{total IT equipment power capacity of DC}}$</p>	(Brotherton 2013; Alger 2010)
2	Compute Power Efficiency (CPE)	CPE	operation	energy (secondary energy)	IT equipment	quantify the efficiency of IT equipment utilization in DCs	$CPE = \frac{IT \text{ Equipment Utilization (ITEU)} * IT \text{ Equipment Power}}{\text{Total Facility Power}} =$ $\frac{ITEU}{PUE} = ITEU \times DCiE$	(The Green Grid 2008)

Source: Oeko-Institut

Annex 6.3: Overview of metrics in terms of environmental performance and useful IT-Performance combined: productivity proxy metrics

Table 53: Productivity proxy metrics

No	Name of metrics	acronym	Scope: Life stages covered	Scope: targeted environmental aspects	Scope: Field of application	Description	Computational formula	Source
1	Cumulated Performance Efficiency (CPE)	CPE	operation + upstream process of electricity generation	energy (primary energy)	IT equipment	the total performance to the cumulated energy demand (CED) during its lifecycle	$CPE = \frac{Operations}{CED}$	(Peñaherrera and Szczepaniak 2018)
2	IT Productivity per Embedded Watt (IT-PEW)	IT-PEW	operation	energy (secondary energy)	IT equipment	Measures the IT energy productivity, work defined as network transaction, storage or computing cycles	$IT - PEW = \frac{Useful\ work\ (Transactions/IO/Cycles)}{IT\ Energy\ consumed}$	Uptime institute (Brill 2007; Schödwell et al. 2018)
3	IT energy Productivity / Equipment Energy Productivity (ITEP/EEP)	ITEP=EEP	operation	energy (secondary energy)	IT Equipment	the completed tasks relative to IT energy use	$ITEP = \frac{Useful\ work\ produced}{IT\ Energy\ consumed\ producing\ this\ work}$	(Schödwell et al. 2018) (Chinnici et al. 2016)
4	Cumulative Energy Efficiency (CEE)	CEE	operation + upstream process of electricity generation	energy (primary energy)	server	a metric to evaluate the energy efficiency of a DC device by relating the useful work during its operational phase to the cumulated energy	$CEE = \frac{useful\ work}{CED}$	(Peñaherrera and Szczepaniak 2018)

						demand (CED) during its lifetime		
5	IT Equipment Efficiency (ITEE); ITEE for servers	ITEE; ITEEsv	operation	energy (secondary energy)	server	maximum performance per kW (measured based on SERT and SPECpower_ssj2008) of all servers or a group of servers in a data centre.	$ITEE_{sv} = \frac{\sum_{i=1}^n \text{maximum or peak performance of a server } i}{\sum_{i=1}^n \text{maximum power consumption of a server } i \text{ in kW}}$	ITEEsv: ISO/IEC 30134-4:2017
6	IT Asset Efficiency (ITAE)	ITAE	operation	energy (secondary energy)	server	Indicates the energy productivity and utilization of the IT systems	$ITAE = ITEE \times ITEU$	(Brotherton 2013; Alger 2010)
	Standard Performance Evaluation Corporation (SPEC®) Power	SPECpower_ssj 2008	operation	energy (secondary energy)	server	measure the energy-efficiency of workloads at multiple load levels	<p>The predecessor to the SPEC SERT. SPEC Power focuses on transactional server-side Java (SSJ) workloads</p> $SPECpower = \frac{\sum \text{performance measured at each load level (ssj_ops)}}{\sum \text{average power at each target load (w)}}$	(SPEC 2008)
7	Standard Performance Evaluation Corporation (SPEC®) SERT: Server Efficiency Rating Tool	SERT™ 2	operation	energy (secondary energy)	server	indicates the overall energy effectiveness of a server. The SERTv2 test method consists of four components which shall be used to accurately obtain a SERTv2 result. These are SERT, PTDaemon, the Client Configuration XML file,	$SERT\ 2\ Efficiency\ Score = \exp(0.65 \times \ln(\text{Eff}_{CPU}) + 0.3 \times \ln(\text{Eff}_{Memory}) + 0.05 \times \ln(\text{Eff}_{Storage}))$ <p>The effectiveness of worklets for a given workload:</p> <ul style="list-style-type: none"> — the CPU workload has seven worklets (Compress, CryptoAES, LU, SHA256, SOR, Sort, and SSJ) — the Memory workload has two worklets (Flood3 and Capacity3); 	(SPEC 2019)

						and the SPEC SERT Run and Reporting Rules.	— the Storage workload has two worklets (Random and Sequential)	
8	ETSI EN 303 470: Energy Efficiency measurement methodology and metrics for servers	SERT™ 2	operation	energy (secondary energy)	server	Energy Efficiency measurement methodology and metrics	Based on the SERT metrics	(ETSI EN 303 470 V1.1.0 2019)
9	Server energy effectiveness metric (SEEM)	SEEM	operation	energy (secondary energy)	server	The SEEM metric(s) is/are an active state and optional idle state numeric result(s) that quantifies a server's energy effectiveness.	the active state portion of SEEM shall be equal to the numeric overall result of SPEC SERTv2. SEEM allows implementers to select test methods for servers where SERTV2 is not applicable.	ISO/IEC 21836: 2020
10	Space, Watts and Performance	SWaP	operation	energy (secondary energy)	server	measure server efficiency	$SWaP = \frac{Performance}{Space \times Power Consumption}$ <p>Performance is measured by industry standard benchmarks, e.g. SPEC; Space addresses the height of the server in rack units.</p>	(Levy and Raviv 2017)
11	DC storage productivity -	DCsP _{cap}	operation	energy (secondary energy)	storage	DCsP _{cap} represents total addressable storage capacity productivity at ready-idle.	$DCsP_{cap} = \frac{Storage System Total Capacity}{Storage System Energy Consumption}$	(The Green Grid 2014b)

	capacity ¹⁸⁶ (DCSP _{cap})							
12	DC storage productivity - Streaming (DCSP _{mb})	DCSP _{mb}	operation	energy (secondary energy)	storage	DCSP _{mb} represents streaming productivity for a specific workload or mix of workloads.	$DCSP_{mb} = \frac{\text{Storage System Streaming}}{\text{Storage System Energy Consumption}}$	(The Green Grid 2014b)
13	DC storage productivity – Transactional (DCSP _{io})	DCSP _{io}	operation	energy (secondary energy)	storage	DCSP _{io} represents transactional productivity for a specific IO workload or mix of IO workloads.	$DCSP_{io} = \frac{\text{Storage System Transactions}}{\text{Storage System Energy Consumption}}$	(The Green Grid 2014b)
14	SNIA Emerald™ Power Efficiency	SNIA Emerald™	operation	energy (secondary energy)	storage	a set of metrics for the evaluation of the related performance and energy consumption of storage products in specific active and idle states	the power efficiency metrics for 3 sets: <ul style="list-style-type: none"> • Disk set: Online, Near-Online • RVML (removable & virtual media library) set: Removable Media Library, Virtual Media Library • NVSS (non-volatile solid state) set: Disk Access Products in different sets are generally not comparable in performance or power efficiency characteristics.	(SNIA 2020)
15	Energy Consumption Rating	ECR	operation	energy (secondary energy)	network	reflects the energy efficiency in correlation to the highest performance capacity of the device	$ECR = \frac{\text{Peak power (in watt)}}{\text{maximum throughput (in bits per second)}}$	(Berwald et al. 2015) ¹⁸⁷

¹⁸⁷ Another publication by the Green Grid Blackburn 2012 describes 3 DC storage Efficiency (DCSE) sub-metrics based on capacity, the number of I/O operations per second and Transfer Throughput. It is assumed that DCSE metrics are the same as DCSP metrics due to the computational formula.

16	Energy Consumption Rating Variable Load	ECR-VL	operation	energy (secondary energy)	network	a variable load metric and intended to differentiate energy efficiency under various workload conditions.	energy consumption under 0%, 10%,30%, 50%,100% load	(Berwald et al. 2015)
17	Telecommunications Energy Efficiency Ratio (TEER)	TEER	operation	energy (secondary energy)	Network: router & switch	to calculate the energy efficiency of individual network equipment by considering three different data utilisation (0%, 50%, and 100%) with associated power consumption	$TEER = \frac{\text{useful work}}{\text{measured Power}}$ <p>measured power consumption (W) at 3 data traffic utilization, namely 0%, 50% and 100%</p> <p>useful work is defined as total data rate (bps) based on ITU-T L. 1310</p> $TEER_{CERT} = D_{TEER} / P_{TEER-CERT}$ $= \sum D_i / \{(P_{CERT-0} + P_{CERT-50} + P_{CERT-100})/3\}$ (A-1) <p>where:</p> <ul style="list-style-type: none"> TEER_{CERT}: certified TEER measured at a specific configuration D_{TEER}: total data rate (bps) P_{TEER-CERT}: measured power consumption (W) D_i: data rate (bps) at a given interface i P_{CERT-0}: measured power consumption (W) at a 0% data traffic utilization P_{CERT-50}: measured power consumption (W) at a 50% data traffic utilization P_{CERT-100}: measured power consumption (W) at a 100% data traffic utilization 	Alliance for Telecommunications Industry Solutions (ATIS) ((ITU-T L-1310 2014; ITU-T L1310 2020)
18	Energy Efficiency Ratio of Equipment (EEER)	EEER	operation	energy (secondary energy)	Network: router & switch	Energy Efficiency of Equipment routers & switches	$EEER = \frac{\text{Total capacity of the interfaces for a fixed configuration model (the sum of interface bandwidth)}}{\text{weighted measured Power of 3 different traffic loads}}$ <p>different traffic loads are defined depending on core equipment or edge/access equipment</p>	(ETSI ES 203 136 v1.2.1 2017)
19	Key Performance Indicators for DC Efficiency	KPI4DC E	whole life cycle	The research study investigated abiotic resource depletion	Server, storage, network equipment,	Research study by German federal Environment Agency: development, testing and dissemination of a practical KPI system for	$Server = \frac{SPECint_rate_OPS_{server}}{GWP_{server}}$ $Storage = \frac{used\ storage\ space_{storage}}{GWP_{storage}}$	(Schödwell et al. 2018)

				(ADP), cumulative energy demand (CED), GWP and Water.	infrastructure	the reliable assessment of the ecological efficiency of DCs	$\text{Network equipment} = \frac{\text{Transfer rate}_{\text{network equipment}}}{\text{GWP}_{\text{network equipment}}}$ $\text{Infrastructure} = \frac{\text{GWP}_{\text{IT}}}{\text{GWP}_{\text{IT}} + \text{GWP}_{\text{Infrastructure}}}$	
20	Corporate Average DC Efficiency	CADE	operation	energy (secondary energy)	DC facility	A combination of the utilization and efficiency of the IT equipment and of the facility. CADE scores are then rated on a five-tier system.	$\text{CADE} = \text{IT Asset Efficiency (IT AE)} \times \text{Facility Efficiency (FE)}$ $\text{IT AE} = \text{IT energy efficiency} \times \text{IT utilization}$ $\text{FE} = \text{Facility energy efficiency (FEE)} \times \text{Facility utilization (FU)}$	(Brotherton 2013; Alger 2010)
21	DC Energy Productivity*	DCeP	operation	energy (secondary energy)	DC facility	quantifies useful work that a DC produces based on the amount of energy it consumes.	$\text{DCeP} = \frac{\text{Useful work produced}}{\text{Total DC Energy consumed producing this work}}$	(The Green Grid 2008; Schödwell et al. 2018)
22	DC energy efficiency and productivity (DC-EEP)	DC-EEP	operation	energy (secondary energy)	DC facility	The delivered IT Productivity “out” to information users per Watt of site infrastructure energy “in”.	$\text{DC} - \text{EEP} = \text{SI} - \text{EER} \times \text{IT} - \text{PEW}$ $\text{IT} - \text{PEW} = \frac{\text{Useful work (Transactions/IO/Cycles)}}{\text{IT Energy consumed}}$ $\text{SI} - \text{EER} = \text{PUE}$	Uptime institute (Brill 2007)

23	DC Performance Efficiency (DCPE)	DCPE	operation	energy (secondary energy)	DC facility	similar to DCeP. The difference is to use power, not energy as defined in DCeP	$DCPE = \frac{\text{Useful work produced}}{\text{Total Facility Power}}$	(The Green Grid 2007)
24	DC Performance Per Energy (DPPE)	DPPE	operation	energy (secondary energy)	DC facility	a combination of four metrics: DCiE/PUE, Green Energy Coefficient (GEC), IT Equipment Energy (ITEE), and IT Equipment Utilisation (ITEU).	$DPPE = ITEU \times ITEE \times DCiE \times \frac{1}{1 - GEC}$ $ITEU = \frac{\text{total measured energy consumption of IT equipment}}{\text{total rated energy consumption of IT equipment}}$	(Green IT Promotion Council 2012)
25	DC Workload Power Efficiency (DWPE)	DWPE	operation	energy (secondary energy)	DC facility: High Performance Computing (HPC) DC	an energy efficiency metric for one specific workload covering the complete DC.	$DWPE = \frac{\text{Workload Power Efficiency (WPE)}}{\text{specific PUE}}$ $WPE = \frac{\text{average achieved performance (Flops)}}{\text{average HPC system power used}}$ Flops: floating-point operations per second	(Wilde 2018)
26	DC Energy Efficiency (DCEE)	DCEE	operation	energy (secondary energy)	DC facility: High Performance Computing (HPC) DC	Multiple weighted DWPE's can be combined to show the energy efficiency for a particular workload mix in a DC which is called DCEE.	$DCEE_{date} = \sum_{i=1}^n w_i \times \frac{DWPE_i}{DWPE_{best \text{ for each workload}}}$ W _i : share of different workload-mix DWPE factors are weighted by the best DWPE for each workload, since performance of different workload can be defined by different units.	(Wilde 2018)

27	DC Fixed to Variable Energy Ratio (DC-FVER)	DC-FVER	operation	energy (secondary energy)	IT equipment or DC facility	measures the ratio of fixed to variable energy to measure how well their IT and site energy consumption tracks the useful work delivered by their IT platforms	$DC - FVER_{IT} = 1 + \frac{Fixed\ Energy_{IT}}{Variable\ Energy_{IT}}$ $DC - FVER_{DC} = 1 + \frac{Fixed\ Energy_{DC}}{Variable\ Energy_{DC}}$	(Newcombe et al. 2012)
28	Carbon Intensity per Unit of Data (CIUD)	CIUD	operation	CO ₂ emission	DC facility	The carbon emissions related to data centre services activity	$CIUD = \frac{CO_2e}{Gigabit\ of\ traffic\ transmitted\ per\ second}$	(Smart city cluster collaboration, Task 1 2014)

*Data Centre Productivity (DCP is the parent metric for DCeP)

Annex 7: Task 1.2.1 References to telecom operators' online public communication of green claims

BT Group (UK)

- <https://www.bt.com/bt-plc/assets/documents/digital-impact-and-sustainability/our-report/report-archive/2020/2020-dis-report.pdf>

Deutsche Telekom AG (Germany)

- <https://www.telekom.com/en/corporate-responsibility/climate-and-environment>
- <https://www.cr-bericht.telekom.com/site20/steuerung-fakten/strategie/cr-strategie-steuerung#atn-16423-132>

KPN (Netherlands)

- <https://www.jaarverslag2020.kpn/downloads/Environmental-figures.pdf>
- <https://www.jaarverslag2019.kpn/downloads/Integrated-Annual-Report-2019-Single-navigation1.pdf>

Orange S.A. (France)

- <https://www.orange.com/en/oranges-commitment-environment>
- https://rai2019.orange.com/wp-content/uploads/sites/38/2020/05/rai_orange2019_en_accessible.pdf

Swisscom AG (Switzerland)

- <https://reports.swisscom.ch/de/2020/report/nachhaltigkeitsbericht/nachhaltigkeitsstrategie/ziele-tabelle>

Telecom Italia S.p.A (Italy)

- https://www.gruppotim.it/content/dam/telecomitalia/en/archive/documents/sustainability/sustainability_reports/2019/NFS-TIM-2019.pdf
- <https://www.gruppotim.it/content/dam/gt/sostenibilit%C3%A0/doc-obbiettivi-e-performance/2020/Environment-Domestic-BU-2019.pdf>

Telefónica S.A. (Spain)

- <https://www.telefonica.com/documents/153952/13347920/2019-Telefonica-Consolidated-Management-Report.pdf>

Telenor Group (Norway)

- <https://www.telenor.com/wp-content/uploads/2020/06/Telenor-Sustainability-Report-2019.pdf>

Telia Company AB (Sweden)

- <https://www.teliacompany.com/en/sustainability/>
- <http://annualreports.teliacompany.com/globalassets/2019/2019en/telia-company--annual-and-sustainability-report-2019.pdf>

Vodafone Group (UK)

- <https://www.vodafone.com/our-purpose/planet/reducing-emissions-in-our-operations>

Annex 8: Task 1.2.3 Standards and measurement methodologies for the monitoring of environmental footprint of electronic communications networks and services

Table 54: List of ECN-relevant standards and methodologies from the ITU and ETSI considered

No.	Titel	Level	network Segment covered	Equipment/System covered	Environmental aspects covered
1	ITU-T L.1310 (09/2020): Energy efficiency metrics and measurement methods for telecommunication equipment	at the equipment and system levels	fixed and mobile networks	<ul style="list-style-type: none"> • DSLAM, MSAM GPON GEPON equipment • Wireless access technologies • Routers, Ethernet switches • WDM/TDM/OTN transport MUXes/switches • Converged packet optical equipment 	operational energy / power
2	ITU-T L.1330 (03/2015): Energy efficiency measurement and metrics for telecommunication networks	at the network level	mobile network	<ul style="list-style-type: none"> • Within the scope of this Recommendation are the radio access parts of the mobile network, namely: radio base stations, backhauling systems, radio controllers and other infrastructure radio site equipment. The technologies covered are: global system for mobile communications (GSM), universal mobile telecommunications communications (UMTS) and long-term evolution (LTE) (including LTE advanced (LTE-A)). • Extrapolation for overall networks 	operational energy / power
3	<ul style="list-style-type: none"> • ITU-T L.1331 (09/2020): Assessment of mobile network energy efficiency • ETSI ES 203 228 V1.3.1 (2020-10): Assessment of mobile network energy efficiency 	at the network level	mobile network	<ul style="list-style-type: none"> • The analysis includes radio base stations, backhauling systems, radio controllers (RCs) and other infrastructure radio site equipment. The technologies involved are global system for mobile communication (GSM), universal mobile telecommunications service (UMTS), long term evolution (LTE) and 5G New Radio (NR). • Extrapolation for overall networks 	operational energy / power
4	ITU-T L.1332 (01/2018): Total network infrastructure energy efficiency metrics	at the network level	Network infrastructure	<ul style="list-style-type: none"> • all telecommunication (TLC)/information and communications technology (ICT) equipment in the network; • all facilities equipment (e.g., cooling systems, site monitoring systems, fire protection and lighting systems); • energy losses in DC power station or AC UPS and in the power distribution; • maintenance activities and site-visit energy used for transportation (e.g., by car); 	<ul style="list-style-type: none"> • operational energy / power • energy associated with maintenance activities

				<ul style="list-style-type: none"> diesel generators used for emergency purposes. 	
5	ITU-T L.1350 (10/2016): Energy efficiency metrics of a base station site	at the equipment and system levels	mobile network: Base station Site	<p>a base station site that normally includes the following types of equipment:</p> <ul style="list-style-type: none"> Telecommunication equipment. Site equipment (e.g., air conditioners, rectifiers, batteries, safety and monitoring equipment). 	operational energy / power
6	<ul style="list-style-type: none"> ITU-T L.1361 (11/2018): Measurement method for energy efficiency of network functions virtualization ETSI ES 203 539 - V1.1.1 - Environmental Engineering (EE); Measurement method for energy efficiency of Network Functions Virtualisation (NFV) in laboratory environment 	at the equipment and system levels	virtualized network functions and infrastructure	<ul style="list-style-type: none"> The virtualized network functions (VNFs) are the software implementations of network functions which run over the NFV infrastructure (NFVI). NFVI includes any physical and virtualized resources for supporting the execution of the VNFs. 	<ul style="list-style-type: none"> operational energy / power useful output of VNFs depending on the different types of VNFs, e.g. throughput (e.g. bps) for a data plane VNF, or capacity (e.g. number of subscribers) for a control plane VNF
7	ETSI EN 303 215 V1.3.1 (2015-04): Measurement methods and limits for power consumption in broadband telecommunication networks equipment	at the equipment and system levels	fixed network	The European Standard (EN) considers DSLAM DSL, MSAN, GPON OLT and Point to Point OLT equipment.	operational energy / power
8	ETSI EN 303 472 V1.1.1 (2018-10): Energy Efficiency measurement methodology and metrics for RAN equipment	at the equipment and system levels	radio access network	only applicable to BS sites supporting a single operator network.	operational energy / power
9	ETSI EN 305 200-2-2 V1.2.1 (2018-08): Access, Terminals, Transmission and Multiplexing (ATTM); Energy management; Operational infrastructures; Global KPIs; Part 2: Specific requirements; Sub-part 2: Fixed	at the network level	Fixed broadband access networks	the energy consumption of NTE (Network Telecommunications Equipment) dedicated to each FAN service at each OS (Operator Site), at each NDN (Network Distribution Node) and at each LOC (Last Operator Connection point).	<ul style="list-style-type: none"> energy consumption; task effectiveness; renewable energy.

	broadband access networks				
10	ETSI EN 305 200-2-3 V1.1.1 (2018-06): Access, Terminals, Transmission and Multiplexing (ATTM); Energy management; Operational infrastructures; Global KPIs; Part 2: Specific requirements; Sub-part 3: Mobile broadband access networks	at the network level	Mobile broadband access networks	<ul style="list-style-type: none"> • UTRA, WCDMA (IMT-2000 Direct Spread, W-CDMA, UMTS); • E-UTRA, LTE (IMT-2000 and IMT advanced); • GSM (IMT-2000 SC, Technology GSM/EDGE). 	<ul style="list-style-type: none"> • energy consumption; • task effectiveness; • renewable energy.
11	ETSI ES 201 554 V1.2.1 (2014-07): Measurement method for Energy efficiency of Mobile Core network and Radio Access Control equipment	at the network level	Mobile Core network and Radio Access Control	<ul style="list-style-type: none"> • Mobiland PGW/SGW). • Radio Access Controller (RNC). 	operational energy / power
12	ETSI ES 202 706-1 V1.6.0 (2020-11): Metrics and measurement method for energy efficiency of wireless access network equipment; Part 1: Power consumption - static measurement method	at the equipment and system levels	mobile network: access equipment	<p>The standard covers base stations with the following radio access technologies:</p> <ul style="list-style-type: none"> • GSM (Global System for Mobile communication) • WCDMA (Wideband Code Division Multiple Access) • LTE (Long Term Evolution) • NR (New Radio) 	operational energy / power
13	ETSI ES 203 136 V1.2.1 (2017-10): Measurement methods for energy efficiency of router and switch equipment	at the equipment and system levels	fixed and mobile networks: routers and switches	<ul style="list-style-type: none"> • Core, edge and access routers • Ethernet switches, 	operational energy / power
14	ETSI ES 203 184 V1.1.1 (2013-03): Measurement Methods for Power Consumption in Transport Telecommunication Networks Equipment	at the equipment and system levels	all the transmission equipment connected to the network by means of wired medium (i.e. copper or fiber), typically running at the network OSI level 1 and OSI level 2	Typical subparts for Transport equipments are: Fans modules, Power supply modules, service cards (i.e. Controller and communication units), Switching units, Data interface boards, subtended subracks.	operational energy / power

15	ETSI TS 102 706-2 V1.5.1 (2018-11): Metrics and Measurement Method for Energy Efficiency of Wireless Access Network Equipment; Part 2: Energy Efficiency - dynamic measurement method	at the equipment and system levels	mobile network: access equipment	This TS covers LTE radio access technology. The total energy consumption of the base station will be the sum of weighted energy consumption for each traffic level i.e. low, medium and busy-hour traffic.	operational energy / power
16	ETSI EN 305 174-8 V1.1.1 (2018-01): Access, Terminals, Transmission and Multiplexing (ATTM); Broadband Deployment and Lifecycle Resource Management; Part 8: Management of end of life of ICT equipment (ICT waste/end of life)	at the equipment and system levels	general ICT equipment	WEEE within ICT sites, core and access networks	Management of WEEE calculation of recycling and recovery rates

ITU-T L.1310 (09/2020): Energy efficiency metrics and measurement methods for telecommunication equipment	
Name of Initiative/ Methodology	Recommendation ITU-T L.1310 (ITU-T L1310 2020)
Link	https://www.itu.int/rec/T-REC-L.1310-202009-I/en
Region/ Country of implementation	International
Developed by	<input checked="" type="checkbox"/> Government <input type="checkbox"/> Industry Association <input type="checkbox"/> National <input type="checkbox"/> National <input checked="" type="checkbox"/> Multi-national <input type="checkbox"/> Multi-national <input type="checkbox"/> Others (Specify)
Compliance	<input type="checkbox"/> Mandatory <input checked="" type="checkbox"/> Voluntary
Verification	<input checked="" type="checkbox"/> Self-Declaration <input type="checkbox"/> Third Party Verification
Scope	<input type="checkbox"/> Manufacturing <input checked="" type="checkbox"/> Use <input type="checkbox"/> End-of-Life
Environmental Focus	<input type="checkbox"/> GWP <input checked="" type="checkbox"/> Energy consumption <input type="checkbox"/> Other environmental impacts
General Description	Energy efficiency metrics and measurement methods are defined for telecommunication network equipment and small networking equipment. These

	<p>metrics allow for the comparison of equipment within the same class, e.g., equipment using the same technologies.</p>
Sector Coverage	<ul style="list-style-type: none"> • DSLAM, MSAM GPON GEPON equipment¹⁸⁸ • Wireless access technologies • Routers, Ethernet switches • WDM/TDM/OTN transport MUXes/switches • Converged packet optical equipment
Specified Methodology	<p>Energy efficiency rating (EER) is defined as a weighted, load-proportional metric. The EER metrics shall be the maximum throughput per average power consumption</p> <ul style="list-style-type: none"> • Metric for DSLAM, MSAM GPON GEPON equipment: Equipment with line cards working at different profiles/states shall be characterized with different metric values for each specific profile/state. $P_{\text{port}} = P_{\text{EQ}} / N_{\text{ports}} \text{ [W/port]} \quad (9)$where: P_{EQ} is the power (in watts) of a fully equipped wireline network equipment with its line cards working in a specific profile/state (e.g., all VDSL2 subscriber lines in L0 state, all ADSL2+ subscriber lines in L2 state). N_{ports} is the maximum number of ports served by the broadband network equipment under test. • Metric for wireless access technologies <ul style="list-style-type: none"> ○ Metric for wireless access equipment RF (radio frequency) energy efficiency over three different load levels The proposed energy efficiency metric at RF unit level is: $E_{\text{ERFU}} = E_{\text{output}} / E_{\text{RFU}} \quad (10-1)$where: E_{output} is daily RF output energy consumption [Wh] under different loads E_{RFU} is daily RF units energy consumption [Wh] under different loads E_{output} and E_{RFU} are defined as: $E_{\text{output}} = P_{\text{BH, output}} \times t_{\text{BH}} + P_{\text{med, output}} \times t_{\text{med}} + P_{\text{low, output}} \times t_{\text{low}} \quad (10-2)$$E_{\text{RFU}} = P_{\text{BH, RFU}} \times t_{\text{BH}} + P_{\text{med, RFU}} \times t_{\text{med}} + P_{\text{low, RFU}} \times t_{\text{low}} \quad (10-3)$In which $P_{\text{BH, output}}$, $P_{\text{med, output}}$ and $P_{\text{low, output}}$ [W] are RF output power under three different load levels defined for static scenario in [ETSI ES 202 706-1] and for dynamic scenario in [ETSI TS 102 706-2]; $P_{\text{BH, RFU}}$, $P_{\text{med, RFU}}$ and $P_{\text{low, RFU}}$ [W] are the power consumption of RF units under three different load levels; t_{BH}, t_{med} and t_{low} [hour] are durations of different load levels during a day. The metric for static scenario is applicable to GSM, UMTS and LTE and for dynamic scenario only for LTE. <ul style="list-style-type: none"> ○ Metric for wireless access equipment dynamic energy efficiency Energy efficiency metrics for RBS under different dynamic loads (low load, medium load and busy-hour load) are defined in [ETSI TS 102 706-2]. In this specification the energy efficiency of an RBS consists of the ratio between the work done in terms of delivered bits to the UEs and the consumed energy for delivering these bits. The KPI presented in this specification is energy efficiency in [bits/Wh]. • Metric for routers and Ethernet switches:

¹⁸⁸ digital subscriber line access multiplexer (DSLAM), multiservice access node (MSAN), gigabit passive optical network (GPON) and gigabit Ethernet passive optical network (GEPON) equipment.

The proposed metric is:

$$EER = T_i / P_w \quad [\text{Mbit/ss/W}] \quad (11-1)$$

where:

T_i is weighted throughput

P_w is weighted power (energy consumption rate)

$$T_i = a \times T_{u1} + b \times T_{u2} + c \times T_{u3} \quad (11-2)$$

$$P_w = a \times P_{u1} + b \times P_{u2} + c \times P_{u3} \quad (11-3)$$

where:

(a, b, c) = relative weights for utilization levels, where $a + b + c = 1$; see Tables 11-1 and 11-2.

(P_{u1} , P_{u2} , P_{u3}) = power measured at respective utilization levels

(T_{u1} , T_{u2} , T_{u3}) = throughput measured at respective utilization levels; see Tables 11-1 and 11.2.

Table 11-1 – Class definitions, EER calculation parameters and load profiles for routing equipment

Class	Representative utilization	% of utilization for energy measurements, u1, u2, u3	Weight multipliers a, b, c	Traffic profile simple IMIX
Access router	1-3%	0, 10, 100	a=0.1, b=0.8, c=0.1	(IPv4)
Edge router	3-6%	0, 10, 100	a=0.1, b=0.8, c=0.1	IPv4/6/MPLS
Core router	20-30%	0, 30, 100	a=0.1, b=0.8, c=0.1	IPv4/6/MPLS

Table 11-2 – Class definitions, EER calculation parameters and load profiles for Ethernet switching equipment

Class	Representative utilization	% of utilization for energy measurements, u1, u2, u3	Weight multipliers a, b, c	Traffic profile simple IMIX, unicast
Access	1-3%	0, 10, 100	a=0.1, b=0.8, c=0.1	Ethernet
High speed access	5-8%	0, 10, 100	a=0.1, b=0.8, c=0.1	Ethernet
Distribution/Aggregation	10-15%	0, 10, 100	a=0.1, b=0.8, c=0.1	Ethernet
Core	15-20%	0, 30, 100	a=0.1, b=0.8, c=0.1	Ethernet
Data centre	12-18%	0, 30, 100	a=0.1, b=0.8, c=0.1	Ethernet

- **Metrics for WDM/TDM/OTN transport MUXes/switches**

The metrics for transport equipment excluding microwave radio equipment are defined in [ATIS-0600015.02.2009]. The EEER defined in ETSI ES 203 184 V1.1.1 (2013-03) is calculated with the same formula of the ATIS standard [ATIS-0600015.02.2009].

- **Converged packet optical equipment**

- metrics for converged packet optical equipment with **both packet signal and TDM** (Time Division Multiplex) signal functions telecommunications energy efficiency ratio (TEER)

	<p style="text-align: center;"> $TEER_{CERT} = D_{TEER} / P_{TEER-CERT}$ $= \sum D_i / \{(P_{CERT-0} + P_{CERT-50} + P_{CERT-100})/3\}$ (A-1) </p> <p>where:</p> <p> D_{TEER}: total data rate (bps) $P_{TEER-CERT}$: measured power consumption (W) D_i: data rate (bps) at a given interface i P_{CERT-0}: measured power consumption (W) at a 0% data traffic utilization $P_{CERT-50}$: measured power consumption (W) at a 50% data traffic utilization $P_{CERT-100}$: measured power consumption (W) at a 100% data traffic utilization </p> <p>Thus, in practice, $TEER_{CERT}$ for converged packet optical equipment shall be as follows:</p> <p style="text-align: center;"> $TEER_{CERT} = \sum D_i / \{(P_{CERT-0} + P_{CERT-100})/2\}$ $= \text{Maximum throughput/average power consumption}$ (A-3) </p> <p>a) The maximum throughput for converged packet optical equipment I</p> $= \sqrt{(A^2 + B^2)/2}$ (A-4) <p>where:</p> <p> A: maximum throughput (Gbps) of packet functions (port speed (Gbps) × number of ports × number of slots) B: maximum throughput (Gbps) of TDM functions (port speed (Gbps) × number of ports × number of slots) </p> <p>b) The average power consumption for converged packet optical equipment I</p> $= (P_{idle} + P_{max}) / 2$ (A-5) <p>where:</p> <p> P_{idle}: power consumption (W) of total equipment with no data throughput with minimum components and path configuration P_{max}: power consumption (W) of total equipment during main signal transmission with maximum component configuration </p> <p>The metric of converged packet optical equipment I is:</p> $EER = \sqrt{(A^2 + B^2)/2} / \{(P_{idle} + P_{max}) / 2\}$ (A-6) <ul style="list-style-type: none"> • metrics for converged packet optical equipment with packet signal, TDM signal and wavelength division multiplexing (WDM) signal $EER = \sqrt{\{A^2 + B^2 + (C \times \alpha)^2\}/3} / \{(P_{idle} + P_{max})/2\}$ (B-8) <p>where:</p> <p> A: maximum throughput (Gbps) of packet functions (port speed (Gbps) × number of ports × number of slots) B: maximum throughput of TDM function (Gbps) (port speed (Gbps) × number of ports × number of slots) C: maximum throughput of WDM function (Gbps) (port speed (Gbps) × number of ports × number of slots) α: add/drop rate of WDM function </p> <p>The add/drop rate will change with operation status, the maximum capacity of the desired for $\alpha = 1$.</p> <p>In order to maximize use of converged packet optical equipment II features, the equipment configured so that the traffic of WDM signals flowing into the converged packet optical part is maximized and the conditions of A, B, C and α are $C \times \alpha = A + B$.</p>
Interaction with other methodologies	<ul style="list-style-type: none"> • Metrics for RBS under different dynamic loads (low load, medium load and busy-hour load) are defined in [ETSI TS 102 706-2]. • Power consumption metrics for GSM, UMTS and LTE RBS at static load are defined in [ETSI ES 202 706-1].

	<ul style="list-style-type: none"> Metrics for routers and Ethernet switches: [ATIS-0600015.03.2013]¹⁸⁹ Metrics for WDM/TDM/OTN transport MUXes/switches: [ATIS-0600015.02.2009]¹⁹⁰.
Practicability	<p>x not clear on the practicability</p> <ul style="list-style-type: none"> ITU-T Study Group 5 - Environment and circular economy includes Huawei, Hitachi, Telecom Italia, Orange, Littelfuse, Ericsson, Epcos AG, the JRC, TU Budapest, Aalto University, ETRI, NTT¹⁹¹

ITU-T L.1330 (03/2015): Energy efficiency measurement and metrics for telecommunication networks	
Name of Initiative/ Methodology	Recommendation ITU-T L.1330 ¹⁹²
Link	https://www.itu.int/rec/T-REC-L.1330-201503-I
Region/ Country of implementation	International
Developed by	<input checked="" type="checkbox"/> Government <input type="checkbox"/> Industry Association <input type="checkbox"/> National <input type="checkbox"/> National <input checked="" type="checkbox"/> Multi-national <input type="checkbox"/> Multi-national <input type="checkbox"/> Others (Specify)
Compliance	<input type="checkbox"/> Mandatory <input checked="" type="checkbox"/> Voluntary
Verification	<input checked="" type="checkbox"/> Self-Declaration <input type="checkbox"/> Third Party Verification
Scope	<input type="checkbox"/> Manufacturing <input checked="" type="checkbox"/> Use <input type="checkbox"/> End-of-Life
Environmental Focus	<input type="checkbox"/> GWP <input checked="" type="checkbox"/> Energy consumption <input type="checkbox"/> Other environmental impacts
General Description	Recommendation ITU-T L.1330 provides a set of metrics for the assessment of energy efficiency (EE) of telecommunication (TLC) mobile networks, together with proper measurement methods.
Sector Coverage	Within the scope of this Recommendation are the radio access parts of the mobile network , namely: radio base stations, backhauling systems, radio controllers and other infrastructure radio site equipment. The technologies covered are: global system

¹⁸⁹ The latest revision is from the 2016 edition:

https://global.ihs.com/doc_detail.cfm?item_s_key=00526067&item_key_date=830431

¹⁹⁰ The latest revision is from the 2016 edition:

https://global.ihs.com/doc_detail.cfm?&item_s_key=00520249&item_key_date=830931&input_doc_number=ATIS%2D0600015%2E02&input_doc_title=

¹⁹¹ <https://www.ictfootprint.eu/en/itu-t-l1330-factsheet>

¹⁹² This recommendation is very similar to the ITU-T L. 1331 that introduces new requirements for radio sites.

	<p>for mobile communications (GSM), universal mobile telecommunications communications (UMTS) and long-term evolution (LTE) (including LTE advanced (LTE-A)).</p>
Specified Methodology	<p>Energy consumption metrics</p> <p>The mobile network energy consumption (EC_{MN}) is the sum of the energy consumption of equipment included in the MN under investigation (see clause 6). The network energy consumption is measured according to the assessment process defined in clause 8 such that individual metrics are provided per radio access technology (RAT) and per operator.</p> $EC_{MN} = \sum_i (\sum_k EC_{BS_{i,k}} + EC_{SI_i}) + \sum_j EC_{BH_j} + \sum_l EC_{RC_l} \quad (1)$ <p>where:</p> <ul style="list-style-type: none"> EC is energy consumption BS refers to the base stations in the MN under measurement BH is the backhaul providing connection to the BSs in the MN under measurement SI is the site infrastructure (rectifier, battery losses, climate equipment, tower mount amplifier (TMA), tower illumination, etc.) RC is the control node(s), including all infrastructure of the RC site i is an index spanning over the number of sites j an index spanning over the number of BH equipment connected to the i-th sites k is the index spanning over the number of BSs in the i-th site l is the index spanning over the control nodes of the MN <p>Performance metrics</p> <ul style="list-style-type: none"> • Capacity (Data volume): PS: packet switched services; CS: circuit switched services (e.g. all voice services, interactive services and video services) $DV_{MN} = DV_{MN-PS} + DV_{MN-CS}$ <ul style="list-style-type: none"> • Coverage area (CoA_{MN}) expressed in m^2 <p>Mobile network energy efficiency metrics</p> <ul style="list-style-type: none"> • Mobile network data energy efficiency ($EE_{MN,DV}$) is the ratio between the performance indicator (DV_{MN}) and the energy consumption (EC_{MN}) when assessed during the same time frame. $EE_{MN,DV} = \frac{DV_{MN}}{EC_{MN}}$ <p>where $EE_{MN,DV}$ is expressed in bit/J.</p> $EE_{MN,CoA} = \frac{coverage\ area}{EC_{MN}}$ <p>where $EE_{MN,CoA}$ is expressed in m^2/J and EC_{MN} is the yearly energy consumption.</p> <p>The method on extrapolation for overall networks based on based on demography classes (dense urban, urban, suburban, rural, unpopulated) is presented.</p> <p>Measurement procedures on measurement of capacity and determination of coverage area are described.</p>
Interaction with other methodologies	<p>This Recommendation was developed jointly by ETSI TC EE and ITU-T Study Group 5 and published respectively by ITU and ETSI as Recommendation ITU-T L.1330 and ETSI Standard ETSI ES 203 228, which are technically equivalent.</p>

	DVMN can be derived from standard counters defined in [ETSI TS 132 425] and [ETSI TS 132 412] for LTE or equivalent used for 2G and 3G, multiplying by the measurement duration T.
Practicability	x not clear on the practicability

ITU-T L.1331 (09/2020): Assessment of mobile network energy efficiency	
ETSI ES 203 228 V1.3.1 (2020-10): Assessment of mobile network energy efficiency	
Name of Initiative/ Methodology	Recommendation ITU-T L.1331 and ETSI ES 230 228 V1.3.1 are technically equivalent.
Link	https://www.itu.int/rec/T-REC-L.1331/en https://www.etsi.org/deliver/etsi_es/203200_203299/203228/01.03.01_60/es_203228v010301p.pdf
Region/ Country of implementation	International
Developed by	<input checked="" type="checkbox"/> Government <input type="checkbox"/> Industry Association <input type="checkbox"/> National <input type="checkbox"/> National <input checked="" type="checkbox"/> Multi-national <input type="checkbox"/> Multi-national <input type="checkbox"/> Others (Specify)
Compliance	<input type="checkbox"/> Mandatory <input checked="" type="checkbox"/> Voluntary
Verification	<input checked="" type="checkbox"/> Self-Declaration <input type="checkbox"/> Third Party Verification
Scope	<input type="checkbox"/> Manufacturing <input checked="" type="checkbox"/> Use <input type="checkbox"/> End-of-Life
Environmental Focus	<input type="checkbox"/> GWP <input checked="" type="checkbox"/> Energy consumption <input type="checkbox"/> Other environmental impacts
General Description	<p>ITU-T L.1331 considers the definition of metrics and methods used to measure energy performance of mobile radio access networks and adopts an approach based on the measurement of such performance on small networks, for feasibility and simplicity purposes.</p> <p>ITU-T L.1331 also provides a method to extrapolate the assessment of energy efficiency to wider networks (i.e. the network in a geographic area, the network in a whole country, the network of a MNO (mobile network operator), etc.).</p>
Sector Coverage	<p>The analysis includes radio base stations, backhauling systems, radio controllers (RCs) and other infrastructure radio site equipment. The technologies involved are global system for mobile communication (GSM), universal mobile telecommunications service (UMTS), long term evolution (LTE) and 5G New Radio (NR).</p> <p>Equipment to be included in the Mobile Network under investigation:</p> <ul style="list-style-type: none"> • Base Stations (Wide area BS, Medium range BS, Local Area BS) • Site equipment (air conditioners, rectifiers/batteries, fixed network equipment, etc.).

	<ul style="list-style-type: none"> • Multi-Access EDGE equipment • Backhaul equipment required to interconnect the BS used in the assessment with the core network. • Radio Controller (RC). • Gateways to connect to the Cloud
Specified Methodology	<p>Energy consumption metrics</p> <ul style="list-style-type: none"> • site energy efficiency (SEE): A metric used to determine the energy efficiency of a telecommunication site. SEE is defined by the ratio of "IT equipment energy" and "Total site energy", which generally includes rectifiers, cooling, storage, security and IT equipment. $SEE = EC_{BSs} / (EC_{BSs} + EC_{SI})$ • The energy consumption of the mobile network (EC_{MN}) is the sum of the energy consumption of each equipment included in the MN under investigation. $EC_{MN} = \sum_i (\sum_k EC_{BS_{i,k}} + EC_{SI_i}) + \sum_m EC_{cells} + \sum_j EC_{BH_j} + \sum_l EC_{RC_l} + \sum_l EC_{CC_l} + \sum_l EC_{LC_l}$ (1) <ul style="list-style-type: none"> where: <i>EC</i> is energy consumption <i>BS</i> refers to the base stations in the MN under measurement <i>BH</i> is the backhauling providing connection to the BSs in the MN under measurement (including transport) <i>SI</i> is the site infrastructure (e.g., rectifier, battery losses, climate equipment, tower mounted amplifier (TMA), tower illumination) <i>RC</i> is the control node(s), including all infrastructure of the RC site <i>CC</i> is the central cloud, LC the local cloud entities, as defined in Figure 1 <i>i</i> is an index spanning over the number of sites <i>j</i> an index spanning over the number of BH equipment connected to the <i>i</i> sites <i>k</i> is the index spanning over the number of BSs in the <i>i</i>-th site <i>l</i> is the index spanning over the control nodes of the MN <i>m</i> is the number of small cells, local cells in the MN. <p>Performance metrics</p> <ul style="list-style-type: none"> • Capacity (Data volume): PS: packet switched services; CS: circuit switched services (e.g. all voice services, interactive services and video services) $DV_{MN} = DV_{MN-PS} + DV_{MN-CS}$ • Coverage area (CoA_{MN}) expressed in m² • Latency (<i>T_{e2e,MN}</i> is the end-to-end user plane latency) <p>Mobile network energy efficiency metrics</p> <ul style="list-style-type: none"> • Mobile network data energy efficiency (EE_{MN,DV}) is the ratio between the data volume (DV_{MN}) and the energy consumption (EC_{MN}) when assessed during the same time period. $EE_{MN,DV} = \frac{DV_{MN}}{EC_{MN}}$ <p>where EE_{MN,DV} is expressed in bit/J.</p> • Mobile network coverage energy efficiency (EE_{MN,CoA}) is the ratio between the area covered by the MN under investigation and the energy consumption when assessed for one year.

	$EE_{MN,CoA} = \frac{CoA_{des_{MN}}}{EC_{MN}}$ <p>where $EE_{MN,CoA}$ is expressed in m^2/J</p> <ul style="list-style-type: none"> Latency based metric is the inverse ratio of the end-to-end user plane latency and the energy consumed by the MN. $EE_{MN,L} = \frac{1}{T_{e2e,MN} * EC_{MN}}$ <p>where $EE_{MN,L}$ is expressed in ms^{-1}/J.</p> <p>Extrapolation for overall networks</p> <p>The sub-network data is extrapolated to overall/total networks according to demography (5 classes: dense urban, urban, suburban, rural, unpopulated), topography (3 classes: Flat, Rolling, Mountainous) and climate classifications (5 classes: Tropical, dry, temperate, cold, polar). The extrapolation is done according to statistical information that indicates how recurrent the sub-network is within the total network to be addressed.</p>
Interaction with other methodologies	<p>Recommendation ITU-T L.1331 was developed jointly by ETSI TC EE and ITU-T Study Group 5 and published by ITU and ETSI as Recommendation ITU-T L.1331 and ETSI Standard ETSI ES 203 228 respectively, which are technically equivalent.</p> <p>DVMN can be derived from standard counters defined in [ETSI TS 132 425] and [ETSI TS 132 412] for LTE or equivalent used for 2G and 3G, multiplying by the measurement duration T. The counters (in [ETSI TS 132 425] and [ETSI TS 132 412]) also account for the quality of service (QoS) being reported in the QoS class identifier (QCI) basis (see [ETSI TS 123 203]). For 5G non virtualized environments, the DV can be derived from [b-ETSI TS 128 552].</p> <p>The measurements in testing laboratories of the efficiency of the Base Stations is the topic treated in ETSI ES 202 706</p>
Practicability	<p>Huawei calculated and published SIEE according to ETSI ES 203 228 https://www.huawei.com/minisite/ict2016/en/topics2.html</p>

ITU-T L.1332 (01/2018): Total network infrastructure energy efficiency metrics

Name of Initiative/ Methodology	Recommendation ITU-T L.1332	
Link	https://www.itu.int/rec/T-REC-L.1332-201801-I	
Region/ Country of implementation	International	
Developed by	<input checked="" type="checkbox"/> Government <input type="checkbox"/> Industry Association <input type="checkbox"/> National <input type="checkbox"/> National <input checked="" type="checkbox"/> Multi-national <input type="checkbox"/> Multi-national <input type="checkbox"/> Others (Specify)	
Compliance	<input type="checkbox"/> Mandatory <input checked="" type="checkbox"/> Voluntary	
Verification	<input checked="" type="checkbox"/> Self-Declaration <input type="checkbox"/> Third Party Verification	
Scope	<input type="checkbox"/> Manufacturing <input checked="" type="checkbox"/> Use including maintenance activities (site-visit) <input type="checkbox"/> End-of-Life	
Environmental Focus	<input type="checkbox"/> GWP <input type="checkbox"/> Other environmental impacts	<input checked="" type="checkbox"/> Energy consumption
General Description	<p>This Recommendation specifies principles and concepts of energy efficiency metrics and measurement methods to evaluate the energy efficiency of an entire network consisting of telecommunication equipment and infrastructure equipment.</p>	
Sector Coverage	<p>Recommendation ITU-T L.1332 contains the basic definition of energy efficiency metrics and measurement methods required to evaluate the energy efficiency of a total network, including the energy consumption for:</p> <ul style="list-style-type: none"> • all telecommunication (TLC)/information and communications technology (ICT) equipment in the network; • all facilities equipment (e.g., cooling systems, site monitoring systems, fire protection and lighting systems); • energy losses in DC power station or AC UPS and in the power distribution; • maintenance activities and site-visit energy used for transportation (e.g., by car); • diesel generators used for emergency purposes. 	
Specified Methodology	Total network infrastructure energy efficiency definition (NIEE)	

The metric for the total network infrastructure energy efficiency (NIEE) is defined as:

$$NIEE = \frac{\text{ICT load energy consumption}}{\text{Total energy consumption of the network}}$$

where:

Total energy consumption of the network includes:

- total input of electrical energy in network sites, excluding the energy provided by diesel/gas generators;
- energy produced by diesel/gas consumption from fixed generators;
- energy produced by renewable sources;
- diesel consumption for movable generators (optional);
- gasoline consumption of vehicles used for maintenance;
- energy consumption of other infrastructure activities e.g., routine test on batteries, control/monitoring systems, building fire detection, building access control, lighting.

ICT Load energy consumption

Load energy consumption shall be assessed site by site and summed as reported in the formula below to calculate the global indicator.

$$\text{Load energy consumption} = \sum_1^n (E_{loadAC_{site_i}} + E_{loadDC_{site_i}})$$

the energy consumption of AC load (E_{loadAC}) and the energy consumption of DC load (E_{loadDC})

Total network energy consumption

Total energy consumption shall be assessed site by site and summed as reported in the formula below to calculate the global indicator including optional contributions due to movable generators and maintenance activities.

$$\text{Total network energy consumption} = EM + EMG + \sum_1^n (E_{i_{site_i}} + ELG_{site_i} + ELR_{site_i})$$

where:

EM: energy generated by movable generators (optional) in kWh

EMG: gasoline consumption in kWh of vehicles for maintenance (optional). This value can be assessed by conversion, in kWh, of average fuel litter consumption in a year and with a defined conversion factor

$E_{i_{site_i}}$: total input electric energy of site and core-rooms excluding the energy provided by diesel/gas generators of site n

ELG_{site_i} : energy produced by diesel/gas consumption for fixed generators of site i

ELR_{site_i} : energy produced by renewable sources of site i .

Global indicator relationship

The NIEE can be used with other indicators, such as the ratio of service/equipment present in the network, to obtain a global indicator of the network that considers the facilities and telecommunication/service parts.

$$NEE = \frac{\sum T_s}{\sum E_{site}} = \frac{\sum T_s}{\sum E_{Ts}} \times \frac{\sum E_{Ts}}{\sum E_{site}} = \frac{\sum T_s}{\sum E_{Ts}} \times NIEE$$

Assuming:

- NIEE is the global network efficiency;
- T_s is the service provided by various parts of the network;
- E_{site} is the energy consumption of a site;
- E_{Ts} is the energy consumption of telecommunication equipment.

Interaction with other methodologies	<ul style="list-style-type: none"> ICT energy consumption shall be directly measured or reported by using the measurement defined in [b-ETSI ES 202 336-12]. The term $\Sigma Ts/\Sigma ETs$ is the network telecom energy efficiency indicator and can be obtained using the methodology defined in [ITU-T L.1330].
Practicability	x not clear on the practicability

ITU-T L.1350 (10/2016): Energy efficiency metrics of a base station site	
Name of Initiative/ Methodology	Recommendation ITU-T L.1350
Link	https://www.itu.int/rec/T-REC-L.1350-201610-I
Region/ Country of implementation	International
Developed by	<input checked="" type="checkbox"/> Government <input type="checkbox"/> Industry Association <input type="checkbox"/> National <input type="checkbox"/> National <input checked="" type="checkbox"/> Multi-national <input type="checkbox"/> Multi-national <input type="checkbox"/> Others (Specify)
Compliance	<input type="checkbox"/> Mandatory <input checked="" type="checkbox"/> Voluntary
Verification	<input checked="" type="checkbox"/> Self-Declaration <input type="checkbox"/> Third Party Verification
Scope	<input type="checkbox"/> Manufacturing <input checked="" type="checkbox"/> Use <input type="checkbox"/> End-of-Life
Environmental Focus	<input type="checkbox"/> GWP <input checked="" type="checkbox"/> Energy consumption <input type="checkbox"/> Other environmental impacts
General Description	<p>This Recommendation specifies principles and concepts of energy efficiency metrics used to evaluate the energy efficiency of a base station site considering the energy consumption for:</p> <ul style="list-style-type: none"> the telecom equipment inside the base station site e.g., backhaul and base station equipment; the entire infrastructure, including cooling systems, monitoring systems (for power consumption, equipment running status, environment parameters, etc.), fire protection and lighting systems for all the sites; energy losses due to AC/DC rectifiers, generators and cable losses.
Sector Coverage	<p>The metrics developed in this Recommendation consider a base station site that normally includes the following types of equipment:</p> <ul style="list-style-type: none"> Telecommunication equipment. Site equipment (e.g., air conditioners, rectifiers, batteries, safety and monitoring equipment).

Specified Methodology	<p>Site energy efficiency (SEE) represents the site efficiency of the measured site:</p> <p>Site energy efficiency (SEE) is the ratio between the total energy consumption telecommunication equipment and the total energy consumption on site:</p> $SEE = \frac{E_{CT}}{E_{TS}} \times 100\%$ $E_{TS} = E_{GE} + E_{FE}$ <p>Where:</p> <ul style="list-style-type: none"> E_{CT} is the energy consumption of telecommunications equipment present in the base station site under consideration during the measurement time period E_{GE} is the input electric energy (in kWh) from the public grid during the measurement time period E_{FE} is locally produced electrical energy (in kWh) generated by a genset or other type of local generator with a renewable energy source on the site during the measurement time period.
Interaction with other methodologies	<p>[ITU-T L.1351] <i>Energy efficiency measurement methodology for base station sites</i> contains the methodology for base-station site energy efficiency parameter measurement in line with metrics established by [ITU-T L.1350].</p> <p>Power and energy efficiency metrics and measurements for individual site elements of base stations are described in several ITU-T Recommendations, such as [ITU-T L.1310] for radio base stations and [ITU-T L.1320] for power and cooling equipment.</p>
Practicability	x not clear on the practicability

<p>ITU-T L.1361 (11/2018): Measurement method for energy efficiency of network functions virtualization</p> <p>ETSI ES 203 539 - V1.1.1 (2019-06) - Environmental Engineering (EE); Measurement method for energy efficiency of Network Functions Virtualisation (NFV) in laboratory environment</p>	
Name of Initiative/ Methodology	<ul style="list-style-type: none"> • Recommendation ITU-T L.1361 • ETSI ES 203 539 - V1.1.1 <p>are technically equivalent</p>
Link	<p>https://www.itu.int/rec/T-REC-L.1361-201811-I</p> <p>https://www.etsi.org/deliver/etsi_es/203500_203599/203539/01.01.01_60/es_203539v010101p.pdf</p>
Region/ Country of implementation	International
Developed by	<input checked="" type="checkbox"/> Government <input type="checkbox"/> Industry Association <input type="checkbox"/> National <input type="checkbox"/> National

	<input checked="" type="checkbox"/> Multi-national <input type="checkbox"/> Multi-national <input type="checkbox"/> Others (Specify)
Compliance	<input type="checkbox"/> Mandatory <input checked="" type="checkbox"/> Voluntary
Verification	<input checked="" type="checkbox"/> Self-Declaration <input type="checkbox"/> Third Party Verification
Scope	<input type="checkbox"/> Manufacturing <input checked="" type="checkbox"/> Use <input type="checkbox"/> End-of-Life
Environmental Focus	<input type="checkbox"/> GWP <input type="checkbox"/> Other environmental impacts <input checked="" type="checkbox"/> Energy consumption
General Description	<p>Network functions virtualization (NFV) changes the traditional telecom network architecture by replacing physical equipment with network functions running on a standard server platform. Three main domains are identified in high-level NFV architecture.</p> <ul style="list-style-type: none"> • The virtualized network functions (VNFs) are the software implementations of network functions which run over the NFV infrastructure (NFVI). • NFVI includes any physical and virtualized resources for supporting the execution of the VNFs. • NFV management and orchestration (MANO) covers the orchestration and lifecycle management of physical and/or software resources that support the infrastructure virtualization and the lifecycle management of VNF itself. <p>The three decoupled elements, connected through standardized and open interfaces, can be provided by different vendors. VNFs and NFVI are the dominant parts from an energy consumption point of view.</p>
Sector Coverage	<p>This Recommendation defines the metrics and measurement methods for the evaluation of the energy efficiency of functional components of a network functions virtualization (NFV) environment. The Recommendation is not try to cover all different types of VNFs (Virtualized Network Functions) (e.g., firewall, gateway, etc.), but it does provide the basis to make an extensible definition.</p>
Specified Methodology	<p>There are two methods to indirectly measure energy consumption of a VNF:</p> <ul style="list-style-type: none"> • Measure the energy consumption of NFVI which only deploys a VNF under test. • Measure the resource consumption of a VNF under test which runs solely on a NFVI platform. <p>Energy efficiency of NFVI can be expressed as the service capacity of reference VNFs running on it with the amount of energy consumption.</p>

Metrics for VNF energy efficiency

The VNF's energy efficiency ratio (EER) metric is defined as:

$$VNF_EER_i = \frac{\text{Useful output}}{\text{Power consumption}} = \frac{U_i}{P_i}$$

$$VNF_EER = \sum_{i=1}^N (VNF_EER_i \times w_i)$$

U_i is the useful output of VNF under service capacity level i . Depending on the different types of VNFs, it can be throughput (e.g., bit per second (bps), packet per second (pps)) for a data plane VNF, or capacity (e.g., number of subscribers or sessions) for a control plane VNF.

P_i is the power consumption of a NFVI platform introduced by a VNF deployed under service capacity level i .

VNF_EER_i is energy efficiency of a VNF under service capacity level i .

VNF_EER is weighted energy efficiency of all service capacity levels.

N is the total number of service capacity levels and w_i is the weight coefficient of level i .

Metrics for VNF resource efficiency

The VNF's resource efficiency ratio (RER) metric can be defined as:

$$VNF_RER_i = \frac{\text{Useful output}}{\text{Resource consumption}} = \frac{U_i}{\{R_{cpu}, R_{memory}, R_{storage}, R_{network}\}_i}$$

$$VNF_RER = \sum_{i=1}^N (VNF_RER_i \times w_i)$$

U_i is the useful output of VNF under service capacity level i . Depending on the different types of VNFs, it can be throughput (e.g., bps, pps) for a data plane VNF, or capacity (e.g., number of subscribers or sessions) for a control plane VNF.

VNF_RER_i is resource efficiency of VNF under service capacity level i .

VNF_RER is weighted resource efficiency of all service capacity levels.

N is the total number of service capacity levels and w_i is the weight coefficient of level i .

Resource consumption of virtual machines (VMs) allocated to a VNF SUT under service capacity level i is specified as follows:

R_{cpu} is CPU resource consumption, defined as used CPU capacity of the underlying VMs related to VNF.

R_{memory} is memory resource consumption, defined as total memory used of the underlying VMs related to VNF.

$R_{storage}$ is storage resource consumption, defined as total storage used of the underlying VMs related to VNF.

$R_{network}$ is network resource consumption, defined as the sum of average network throughput of bytes transmitted and received per second.

Metrics for NFVI energy efficiency

The NFVI's energy efficiency ratio (EER) metric is defined as:

	$NFVI_EER_{VNF_j} = \frac{\text{Useful output of } VNF_j}{\text{Power consumption}_j} = \sum_{i=1}^N \left(\frac{U_{i,j}}{P_{i,j}} \times w_i \right)$ $NFVI_EER = \{NFVI_EER_{VNF_j}\}, j \in \{1, 2, \dots\}$ <p>$U_{i,j}$ is the useful output of VNF_j under service capacity level i.</p> <p>$P_{i,j}$ is power consumption of NFVI platform with VNF_j deployed under service capacity level i.</p> <p>$NFVI_EER_{VNF_j}$ is energy efficiency of NFVI platform with VNF_j deployed.</p> <p>$NFVI_EER$ is the aggregation of all energy efficiency of NFVI platform with different VNFs deployed.</p>
Interaction with other methodologies	<p>R_{cpu} is calculated as average CPU utilization, see clause 6.6 of [ETSI GS NFV-TST 008], multiplied by clock speed in megahertz (MHz) of CPU and number of cores.</p> <p>R_{memory} is total memory used by VNF, which is derived from other memory metrics, see clause 8.6 of [ETSI GS NFV-TST 008].</p> <p>$R_{storage}$ is the amount of disk occupied by VNF on the host machine, see Annex A in [ETSI GS NFV-IFA 027]. As the methods of measurement for storage systems vary widely and depend on the implementation, storage metrics are not defined in [ETSI GS NFV-TST 008].</p> <p>$R_{network}$ is the average network throughput of bytes transmitted and received per second by VNF external connection point, see clause 7.2 of [ETSI GS NFV-TST 008].</p>
Practicability	x not clear on the practicability

ETSI EN 303 215 V1.3.1 (2015-04): Measurement methods and limits for power consumption in broadband telecommunication networks equipment	
Name of Initiative/ Methodology	Measurement methods and limits for power consumption in broadband telecommunication networks equipment
Link	https://www.etsi.org/deliver/etsi_en/303200_303299/303215/01.03.01_60/en_303215v010301p.pdf
Region/ Country of implementation	International
Developed by	<input checked="" type="checkbox"/> Government <input type="checkbox"/> Industry Association <input type="checkbox"/> National <input type="checkbox"/> National <input checked="" type="checkbox"/> Multi-national <input type="checkbox"/> Multi-national <input type="checkbox"/> Others (Specify)

Compliance	<input type="checkbox"/> Mandatory <input checked="" type="checkbox"/> Voluntary
Verification	<input checked="" type="checkbox"/> Self-Declaration <input type="checkbox"/> Third Party Verification
Scope	<input type="checkbox"/> Manufacturing <input checked="" type="checkbox"/> Use <input type="checkbox"/> End-of-Life
Environmental Focus	<input type="checkbox"/> GWP <input type="checkbox"/> Other environmental impacts <input checked="" type="checkbox"/> Energy consumption
General Description	The document defines the power consumption metrics, the methodology and the test conditions to measure the power consumption of broadband fixed telecommunication networks equipment. The document does not cover all possible configuration of equipment but only homogenous configurations.
Sector Coverage	The document considers DSLAM DSL, MSAN, GPON OLT and Point to Point OLT equipment.
Specified Methodology	<p>power consumption per port of broadband network equipment</p> <p>The power consumption of broadband telecommunication network equipment is defined as:</p> $P_{BBport} = P_{BBeq} / N_{ports}$ <p>Where:</p> <p>P_{BBeq} is the power consumption (in W) of a fully equipped broadband network equipment, measured at the electric power input interface, placed at the premises of the operator or the equipment supplier, which connects multiple broadband subscribers to a backbone. P_{BBeq} is measured in determined environmental conditions defined in clause 5.1.1.</p> <p>P_{BBport} is the power consumption per port in W of the broadband network equipment for which the limits are defined in the present document.</p> <p>N_{ports} is the maximum number of subscriber lines access ports served by the broadband network equipment under test.</p> <p>Power consumption taking into account the low-power states</p> <p>The low-power states are intended to reduce the power consumption during periods of no or minimal traffic needs (e.g. low data-rate applications or control signalling only). When these low-power states are used, the achievable power consumption reduction can be estimated by using profiles based on user traffic assumptions.</p> <p>No specific metric is defined. Using profiles based on user traffic assumption can be gathered.</p>
Interaction with other methodologies	EU CoC: All power values of the DSL network equipment in line with C.2.1 (except G.fast), C.2.2 and C.2.3 are measured at the power interface port interface as described in the standard ETSI EN 303 215 or at the AC input, in case of directly mains powered systems.
Practicability	x not clear on the practicability

ETSI EN 303 472 V1.1.1 (2018-10): Energy Efficiency measurement methodology and metrics for RAN equipment

Name of Initiative/ Methodology	Energy Efficiency measurement methodology and metrics for RAN equipment	
Link	https://www.etsi.org/deliver/etsi_en/303400_303499/303472/01.01.01_60/en_303472v010101p.pdf	
Region/ Country of implementation	International	
Developed by	<input checked="" type="checkbox"/> Government <input type="checkbox"/> Industry Association <input type="checkbox"/> National <input type="checkbox"/> National <input checked="" type="checkbox"/> Multi-national <input type="checkbox"/> Multi-national <input type="checkbox"/> Others (Specify)	
Compliance	<input type="checkbox"/> Mandatory <input checked="" type="checkbox"/> Voluntary	
Verification	<input checked="" type="checkbox"/> Self-Declaration <input type="checkbox"/> Third Party Verification	
Scope	<input type="checkbox"/> Manufacturing <input checked="" type="checkbox"/> Use <input type="checkbox"/> End-of-Life	
Environmental Focus	<input type="checkbox"/> GWP <input type="checkbox"/> Other environmental impacts	<input checked="" type="checkbox"/> Energy consumption
General Description	<p>The European Standard (EN) specifies KPIs that are only applicable to BS sites supporting a single operator network. KPIs for shared BS and BS site between two operators or more is not considered.</p> <p>The key Performance Indicators (KPIs) and the associated measurement processes as well as requirement on report are defined. This standard reflects the operational energy efficiency of a radio access network and supporting infrastructures as specified in the scope.</p>	
Sector Coverage	<p>the operational energy efficiency of the following digital cellular RAN (radio access network), equipment and supporting infrastructures:</p> <ul style="list-style-type: none"> integrated BS; distributed BS; BS site. <p>The technologies involved are</p> <ul style="list-style-type: none"> UTRA, WCDMA (IMT-2000 Direct Spread, W-CDMA, UMTS); E-UTRA, LTE (IMT-2000 and IMT advanced); GSM (IMT-2000 SC, Technology GSM/EDGE). 	
Specified Methodology	<p>Capacity energy efficiency KPI ($KPI_{EE-capacity}$)</p> <p>This is the data volume of the BS over the backhaul network divided by the total energy consumption of the BS site (including the support infrastructure).</p>	

	$KPI_{EE-capacity} = \frac{\sum data_volume}{E_{SI} + \sum E_{BS}} \text{ Mbits/Wh}$ <p>where:</p> <ul style="list-style-type: none"> • data_volume is the total data volume delivered by the BS site during the measurement period (see clause 6.1.1); • E_{BS} is the total energy consumption of each BS of the BS site during the measurement period (see clause 6.1.1) presented in Wh; • E_{SI} is the total energy consumption of the support infrastructure of the BS site during the measurement period (see clause 6.1.1) presented in Wh. <p>Coverage energy efficiency KPI ($KPI_{EE-coverage}$)</p> <p>This is the coverage area of the BS divided by the total energy consumption of the BS site (including the support infrastructure).</p> $KPI_{EE-coverage} = \frac{A_{coverage}}{E_{SI} + \sum E_{BS}}$ <p>where:</p> <ul style="list-style-type: none"> • $A_{coverage}$ is the BS site coverage area [km²]; • E_{BS} is the total energy consumption of each BS of the BS site during the measurement period (see clause 6.1.1) presented in Wh; • E_{SI} is the total energy consumption of the support infrastructure of the BS site during the measurement period (see clause 6.1.1) presented in Wh. <p>Site energy efficiency KPI ($KPI_{EE-site}$)</p> <p>The $KPI_{EE-site}$ of the BS site is calculated as the total energy consumption of all the BS equipment at the site divided by the total energy consumption of the BS site during the measurement period.</p> $KPI_{EE-site} = \frac{\sum E_{BS}}{E_{SI} + \sum E_{BS}}$ <p>Extended BS total renewable energy KPI ($KPI_{REN-tot}$)</p> $KPI_{REN-tot} = \frac{EL_{renewable\ grid} + EL_{renewable\ on-site}}{EL_{tot}}$ <p>Extended BS on-site renewable energy KPI ($KPI_{REN-onsite}$)</p> $KPI_{REN-local} = \frac{EL_{renewable\ on-site}}{EL_{renewable\ on-site} + EL_{non-renewable\ on-site}}$
Interaction with other methodologies	Site energy efficiency KPI ($KPI_{EE-site}$) is consistent with Recommendation ITU-T L.1350 [i.6].
Practicability	x not clear on the practicability

ETSI EN 305 200-2-2 V1.2.1 (2018-08): Access, Terminals, Transmission and Multiplexing (ATTM); Energy management; Operational infrastructures; Global KPIs; Part 2: Specific requirements; Sub-part 2: Fixed broadband access networks

Name of Initiative/ Methodology	Fixed broadband access networks	
Link	https://www.etsi.org/deliver/etsi_en/305200_305299/3052000202/01.02.01_60/en_3052000202v010201p.pdf	
Region/ Country of implementation	International	
Developed by	<input checked="" type="checkbox"/> Government <input type="checkbox"/> Industry Association <input type="checkbox"/> National <input type="checkbox"/> National <input checked="" type="checkbox"/> Multi-national <input type="checkbox"/> Multi-national <input type="checkbox"/> Others (Specify)	
Compliance	<input type="checkbox"/> Mandatory <input checked="" type="checkbox"/> Voluntary	
Verification	<input checked="" type="checkbox"/> Self-Declaration <input type="checkbox"/> Third Party Verification	
Scope	<input type="checkbox"/> Manufacturing <input checked="" type="checkbox"/> Use <input type="checkbox"/> End-of-Life	
Environmental Focus	<input type="checkbox"/> GWP <input type="checkbox"/> Other environmental impacts	<input checked="" type="checkbox"/> Energy consumption
General Description	Energy management of fixed access networks comprises a number of independent layers. The document addresses performance of infrastructures that supports the normal function of hosted ICT equipment within the fixed access network (e.g. power distribution, environmental control, security and safety).	
Sector Coverage	The totality of a FAN (Fixed access networks) under the governance of a given operator takes into account all NTE (Network Telecommunications Equipment) in terms of energy consumption (both non-renewable and renewable) and task effectiveness.	
Specified Methodology	<p>KPI_{EM} for FANs separately describes the task effectiveness and the renewable energy performance of an entire FAN for a specific service or a collection of services.</p> <p>KPI_{EM} is a combination of two separate KPIs as follows:</p> <p>1) the Objective KPI for task effectiveness, a measure of the data volumes (both upstream and downstream data (bits)) as a function of the energy consumption (Wh). expressed as KPI_{TE};</p> $KPI_{TE} = \frac{\sum_{i=1}^N data_volume_i}{KPI_{EC}}$ <p>KPI_{TE} is expressed with units of bits/Wh</p> <p>2) the Objective KPI for renewable energy contribution expressed as KPI_{REN}; share of renewable energy by fixed access network site (OS (Operator Site), NDN (Network Distribution Node) sites, Last Operator Connection point (LOC) sites).</p>	

	<p>KPI_{REN} is expressed as a percentage.</p> <p>and both of these Objective KPIs incorporate a third Objective KPIs for energy consumption expressed as KPI_{EC}, which is total energy consumption by fixed access network site (OS sites, NDN sites, LOC sites)</p> <p>The Global KPI, KPI_{EM}, presented as its two Objective KPIs, KPI_{TE} and KPI_{REN}, is primarily intended for trend analysis - not to enable comparison between FANs. An increase in either KPI_{TE} or KPI_{REN} represents an improvement in energy management of the network - although individual improvements of KPI_{TE} and KPI_{REN} are not comparable.</p>
Interaction with other methodologies	The present document specifies the requirements for a Global KPI for energy management (KPI _{EM}) and their underpinning Objective KPIs for the fixed access networks (FANs) of broadband deployment. The requirements are mapped to the general requirements of ETSI EN 305 200-1
Practicability	x not clear on the practicability

ETSI EN 305 200-2-3 V1.1.1 (2018-06): Access, Terminals, Transmission and Multiplexing (ATTM); Energy management; Operational infrastructures; Global KPIs; Part 2: Specific requirements; Sub-part 3: Mobile broadband access networks	
Name of Initiative/ Methodology	Mobile broadband access networks
Link	https://www.etsi.org/deliver/etsi_en/305200_305299/3052000203/01.01.01_60/en_3052000203v010101p.pdf
Region/ Country of implementation	International
Developed by	<input checked="" type="checkbox"/> Government <input type="checkbox"/> Industry Association <input type="checkbox"/> National <input type="checkbox"/> National <input checked="" type="checkbox"/> Multi-national <input type="checkbox"/> Multi-national <input type="checkbox"/> Others (Specify)
Compliance	<input type="checkbox"/> Mandatory <input checked="" type="checkbox"/> Voluntary
Verification	<input checked="" type="checkbox"/> Self-Declaration <input type="checkbox"/> Third Party Verification
Scope	<input type="checkbox"/> Manufacturing <input checked="" type="checkbox"/> Use <input type="checkbox"/> End-of-Life
Environmental Focus	<input type="checkbox"/> GWP <input checked="" type="checkbox"/> Energy consumption <input type="checkbox"/> Other environmental impacts
General Description	Energy management of mobile access networks comprises a number of independent layers. The document addresses performance of infrastructures that supports the

	normal function of hosted ICT equipment within the mobile access network (e.g. power distribution, environmental control, security and safety).
Sector Coverage	<p>The document addresses energy management in mobile access networks using, but not restricted to, the following technologies:</p> <ul style="list-style-type: none"> • UTRA, WCDMA (IMT-2000 Direct Spread, W-CDMA, UMTS); • E-UTRA, LTE (IMT-2000 and IMT advanced); • GSM (IMT-2000 SC, Technology GSM/EDGE).
Specified Methodology	<p>KPI_{EM} for mobile access networks separately describes the task effectiveness and the renewable energy performance of an entire mobile access network for a specific service or a collection of services.</p> <p>KPI_{EM} is a combination of two separate KPIs as follows:</p> <p>1) the Objective KPI for task effectiveness, a measure of the data volumes (both upstream and downstream data (bits)) as a function of the energy consumption (Wh). expressed as KPI_{TE};</p> $KPI_{TE} = \frac{\sum_{i=1}^N data_volume_i}{KPI_{EC}}$ <p>KPI_{TE} is expressed with units of bits/Wh</p> <p>2) the Objective KPI for renewable energy contribution expressed as KPI_{REN}; share of renewable energy by mobile access network site (OS (Operator Site), NDN (Network Distribution Node) sites).</p> <p>KPI_{REN} is expressed as a percentage. And both of these Objective KPIs incorporate a third Objective KPIs for energy consumption expressed as KPI_{EC}, which is total energy consumption by mobile access network site (OS sites, NDN sites)</p> <p>The Global KPI, KPI_{EM}, presented as its two Objective KPIs, KPI_{TE} and KPI_{REN}, is primarily intended for trend analysis - not to enable comparison between mobile access networks. An increase in either KPI_{TE} or KPI_{REN} represents an improvement in energy management of the network - although individual improvements of KPI_{TE} and KPI_{REN} are not comparable.</p>
Interaction with other methodologies	Total volume of data and energy consumption for all base stations of the mobile access network as defined in ETSI EN 303 472
Practicability	x not clear on the practicability

ETSI ES 201 554 V1.2.1 (2014-07): Measurement method for Energy efficiency of Mobile Core network and Radio Access Control equipment

Name of Initiative/ Methodology	Measurement method for Energy efficiency of Mobile Core network and Radio Access Control equipment
Link	https://www.etsi.org/deliver/etsi_es/201500_201599/201554/01.02.01_60/es_201554v010201p.pdf
Region/ Country of implementation	International
Developed by	<input checked="" type="checkbox"/> Government <input type="checkbox"/> Industry Association <input type="checkbox"/> National <input type="checkbox"/> National <input checked="" type="checkbox"/> Multi-national <input type="checkbox"/> Multi-national <input type="checkbox"/> Others (Specify)
Compliance	<input type="checkbox"/> Mandatory <input checked="" type="checkbox"/> Voluntary
Verification	<input checked="" type="checkbox"/> Self-Declaration <input type="checkbox"/> Third Party Verification
Scope	<input type="checkbox"/> Manufacturing <input checked="" type="checkbox"/> Use <input type="checkbox"/> End-of-Life
Environmental Focus	<input type="checkbox"/> GWP <input checked="" type="checkbox"/> Energy consumption <input type="checkbox"/> Other environmental impacts
General Description	<p>The ETSI Standard defines energy efficiency metrics and measurement methods for mobile core equipment.</p> <p>The document promotes energy saving features as the traffic profile is a representation of the expected behaviour of the equipment in operation, i.e. the power consumption is measured at different load levels when processing traffic mimicking a typical usage of the equipment. The defined metrics can be used for comparing energy efficiency of different implementations (Hardware and Software) of the same function only.</p>
Sector Coverage	<p>The document defines metrics and measurement methods applicable for the following systems and nodes defined in TS 123 002:</p> <ul style="list-style-type: none"> • Mobile core functions (GGSN, HLR, MGW, MME, MSC, SGSN and PGW/SGW). • Radio Access Controller (RNC). <p>Later revisions will include Base Station Controller (BSC) and IMS core functions (BGCF, CSCF, HSS, IBCF, MRFC, MRFP, SLF and LRF).</p> <p>Energy consumption at site including also climate units, losses, auxiliary equipment, etc. are not observed in this Standard.</p> <p>The system under test is seen as a "black box", i.e. only the total power consumed by the device or shelf/shelves is/are measured and not different parts of the device or shelf/shelves. A "black box" can be viewed solely in terms of its input, output and transfer characteristics without any knowledge of its internal workings.</p>

Specified Methodology	<p>Average power consumption</p> $P_{avg} = \alpha \times P_L + \beta \times P_M + \gamma \times P_H [W] \quad (1a)$ <p>Where α, β, and γ are weight coefficients selected such as $(\alpha + \beta + \gamma) = 1$.</p> <p>The power consumption levels associated with the above load levels are defined as:</p> <ul style="list-style-type: none"> • High load level: PH = average power consumption [W] measured at TH • Mid load level: PM = average power consumption [W] measured at TM • Low load level: PL = average power consumption [W] measured at TL <p>Three normalized traffic profiles are provided:</p> <table border="1" data-bbox="491 779 1374 902"> <thead> <tr> <th rowspan="2">Profiles</th> <th rowspan="2">KPI (Key Performance Indicator)</th> <th colspan="3">P_{avg} weight coefficients</th> </tr> <tr> <th>α</th> <th>β</th> <th>γ</th> </tr> </thead> <tbody> <tr> <td>Subscriber</td> <td>Subscriber</td> <td>0,1</td> <td>0,4</td> <td>0,5</td> </tr> <tr> <td>Data</td> <td>PPS or SAU</td> <td>0,2</td> <td>0,45</td> <td>0,35</td> </tr> <tr> <td>Voice</td> <td>Erlang or Subscriber</td> <td>0,4</td> <td>0,4</td> <td>0,2</td> </tr> </tbody> </table> <p>Energy Efficiency Ratio (EER)</p> <p>The Energy Efficiency Ratio metric, the comparable performance indicator, for Core networks is defined as:</p> $EER = Useful\ Output / P_{avg} [Erlang/W PPS/W Subscribers/W SAU/W] \quad (1b)$ <p>By using the defined traffic models, Useful Output can be translated to Subscribers (Sub) or Simultaneously Attached Users (SAU) also for functions which normally have the maximum capacity expressed in Erlang (Erl) or Packets/s (PPS).</p>	Profiles	KPI (Key Performance Indicator)	P_{avg} weight coefficients			α	β	γ	Subscriber	Subscriber	0,1	0,4	0,5	Data	PPS or SAU	0,2	0,45	0,35	Voice	Erlang or Subscriber	0,4	0,4	0,2
Profiles	KPI (Key Performance Indicator)			P_{avg} weight coefficients																				
		α	β	γ																				
Subscriber	Subscriber	0,1	0,4	0,5																				
Data	PPS or SAU	0,2	0,45	0,35																				
Voice	Erlang or Subscriber	0,4	0,4	0,2																				
Interaction with other methodologies	not clear																							
Practicability	x not clear on the practicability																							

ETSI ES 202 706-1 V1.6.0 (2020-11): Metrics and measurement method for energy efficiency of wireless access network equipment; Part 1: Power consumption - static measurement method	
Name of Initiative/ Methodology	Metrics and measurement method for energy efficiency of wireless access network equipment; Part 1: Power consumption - static measurement method
Link	https://www.etsi.org/deliver/etsi_es/202700_202799/20270601/01.06.00_50/es_20270601v010600m.pdf
Region/ Country of implementation	International

Developed by	<input checked="" type="checkbox"/> Government <input type="checkbox"/> National <input checked="" type="checkbox"/> Multi-national <input type="checkbox"/> Others (Specify) <input type="checkbox"/> Industry Association <input type="checkbox"/> National <input type="checkbox"/> Multi-national
Compliance	<input type="checkbox"/> Mandatory <input checked="" type="checkbox"/> Voluntary
Verification	<input checked="" type="checkbox"/> Self-Declaration <input type="checkbox"/> Third Party Verification
Scope	<input type="checkbox"/> Manufacturing <input checked="" type="checkbox"/> Use <input type="checkbox"/> End-of-Life
Environmental Focus	<input type="checkbox"/> GWP <input type="checkbox"/> Other environmental impacts <input checked="" type="checkbox"/> Energy consumption
General Description	<p>ETSI ES 202 706-1 defines the measurement method for the evaluation of base station power consumption and energy consumption with static load:</p> <ul style="list-style-type: none"> • Average power consumption of BS equipment under static test conditions: the BS average power consumption is based on measured BS power consumption data under static condition when the BS is loaded artificially in a lab for three different loads, low, medium and busy hour under given reference configuration. • Daily average energy consumption. <p>Static measurement means that power consumption measurement is performed with different radio resource configurations with pre-defined and fixed load levels.</p>
Sector Coverage	<p>Energy efficiency is one of the critical factors of the modern telecommunication systems. The energy consumption of the access network is the dominating part of the wireless telecom network energy consumption. Therefore the core network and the service network are not considered in the present document.</p> <p>In the radio access network, the energy consumption of the Base Station is dominating (depending on technology often also referred to as BTS, NodeB, eNodeB, gNodeB etc. and in the present document denoted as BS).</p> <p>The standard covers base stations with the following radio access technologies:</p> <ul style="list-style-type: none"> • GSM (Global System for Mobile communication) • WCDMA (Wideband Code Division Multiple Access) • LTE (Long Term Evolution) • NR (New Radio)
Specified Methodology	<p>Four load levels are used for the BS power consumption and RF output power test: Full Load (FL), Busy Hour load (BH), medium load (med) and low load (low).</p> <p>Calculation of average power consumption of integrated BS</p> $P_{equipment,static} = \frac{P_{BH} \cdot t_{BH} + P_{med} \cdot t_{med} + P_{low} \cdot t_{low}}{t_{BH} + t_{med} + t_{low}}$

	<p>Calculation of daily energy consumption of integrated BS</p> $E_{equipment,static} = P_{BH} \cdot t_{BH} + P_{med} \cdot t_{med} + P_{low} \cdot t_{low}$ <p>Calculation of average power consumption of distributed BS</p> <p>The average power consumption [W] of distributed BS equipment is defined as:</p> $P_{equipment,static} = P_{c,static} + P_{RRH,static}, \quad (7.3)$ <p>in which $P_{c,static}$ and $P_{RRH,static}$ [W] are average power consumption of central and remote parts in static method defined as:</p> $P_{c,static} = \frac{P_{BH,C} \cdot t_{BH} + P_{med,C} \cdot t_{med} + P_{low,C} \cdot t_{low}}{t_{BH} + t_{med} + t_{low}} \quad (7.4)$ $P_{RRH,static} = \frac{P_{BH,RRH} \cdot t_{BH} + P_{med,RRH} \cdot t_{med} + P_{low,RRH} \cdot t_{low}}{t_{BH} + t_{med} + t_{low}} \quad (7.5)$ <p>Calculation of daily energy consumption of distributed BS</p> <p>The daily energy consumption [Wh] of central and remote parts in static method defined as:</p> $E_{c,static} = P_{BH,C} \cdot t_{BH} + P_{med,C} \cdot t_{med} + P_{low,C} \cdot t_{low} \quad (7.6)$ $E_{RRH,static} = P_{BH,RRH} \cdot t_{BH} + P_{med,RRH} \cdot t_{med} + P_{low,RRH} \cdot t_{low} \quad (7.7)$ <p>The daily energy consumption [Wh] of distributed BS equipment in static method is defined as:</p> $E_{equipment,static} = E_{c,static} + E_{RRH,static}, \quad (7.8)$
Interaction with other methodologies	<p>2 of a multi-part deliverable covering Metrics and Measurement Method for Energy Efficiency of Wireless Access Network Equipment, as identified below:</p> <p>ETSI ES 202 706-1: "Power Consumption - Static Measurement Method";</p> <p>ETSI TS 102 706-2: "Energy Efficiency - dynamic measurement method".</p>
Practicability	x not clear on the practicability

ETSI TS 102 706-2 V1.5.1 (2018-11): Metrics and Measurement Method for Energy Efficiency of Wireless Access Network Equipment; Part 2: Energy Efficiency - dynamic measurement method	
Name of Initiative/ Methodology	Metrics and Measurement Method for Energy Efficiency of Wireless Access Network Equipment; Part 2: Energy Efficiency - dynamic measurement method
Link	https://www.etsi.org/deliver/etsi_ts/102700_102799/10270602/01.05.01_60/ts_10270602v010501p.pdf

Region/ Country of implementation	International
Developed by	<input checked="" type="checkbox"/> Government <input type="checkbox"/> Industry Association <input type="checkbox"/> National <input type="checkbox"/> National <input checked="" type="checkbox"/> Multi-national <input type="checkbox"/> Multi-national <input type="checkbox"/> Others (Specify)
Compliance	<input type="checkbox"/> Mandatory <input checked="" type="checkbox"/> Voluntary
Verification	<input checked="" type="checkbox"/> Self-Declaration <input type="checkbox"/> Third Party Verification
Scope	<input type="checkbox"/> Manufacturing <input checked="" type="checkbox"/> Use <input type="checkbox"/> End-of-Life
Environmental Focus	<input type="checkbox"/> GWP <input checked="" type="checkbox"/> Energy consumption <input type="checkbox"/> Other environmental impacts
General Description	<p>The assessment method is covering the BS equipment dynamic efficiency for which the technical specification (TS) defines reference BS equipment configurations and reference load levels to be used when measuring BS efficiency.</p> <p>The total energy consumption of the base station will be the sum of weighted energy consumption for each traffic level i.e. low, medium and busy-hour traffic.</p>
Sector Coverage	This TS covers LTE radio access technology.
Specified Methodology	<p>Total data volume for 24-hours period</p> <p>The measured data volume in bits for low load level is denoted as <i>DV_{measured-low}</i>.</p> <p>The measured data volume in bits for medium load level is denoted as <i>DV_{measured-medium}</i>.</p> <p>The measured data volume in bits for busy-hour load level is denoted as <i>DV_{measured-busy-hour}</i>.</p> <p>The total data volume for 24-hours period is calculated as following:</p> $DV_{total} = \left(DV_{low} \times \frac{W_{low}}{T_{measurement\ low}} \right) + \left(DV_{medium} \times \frac{W_{medium}}{T_{measurement\ medium}} \right) + \left(DV_{busy\ hour} \times \frac{W_{busy\ hour}}{T_{measurement\ busy\ hour}} \right) [bits] \quad (6.1)$ <p>These weighting factors are applied: <i>W_{low}</i> for low traffic, <i>W_{medium}</i> for medium traffic and <i>W_{busy-hour}</i> for busy-hour traffic level.</p> <p><i>DV_{total}</i> is the total delivered bits during the measurement for all three traffic levels.</p> <p>Energy Consumption for the integrated BS</p> <p>The total energy consumption of the base station will be the sum of weighted energy consumption for each traffic level i.e. low, medium and busy-hour traffic.</p>

	<p>$P_{i, equipment}^{traffic_scenario_x}$ is the measured power value for the i^{th} sampled measurement during the measurement period. The energy $E_{equipment}^{traffic_scenario_x}$ which is the energy consumption of the BS during the measurement is calculated as follows:</p> $E_{equipment}^{traffic_scenario_x} = \sum_{k=1}^n (\Delta t_m \cdot P_{k, equipment}^{traffic_scenario_x}) [Wh] \quad (6.2)$ <p>Energy Consumption for the distributed BS</p> <p>$EC, equipment$ and $ERRH, equipment$ [Wh] are the energy consumption of the central and the remote parts in the dynamic method defined as:</p> $E_{RRH, equipment}^{traffic_scenario_x} = \sum_{k=1}^n (\Delta t_m \cdot P_{k, RRH, equipment}^{traffic_scenario_x}) [Wh] \quad (6.3)$ $E_{C, equipment}^{traffic_scenario_x} = \sum_{k=1}^n (\Delta t_m \cdot P_{k, C, equipment}^{traffic_scenario_x}) [Wh] \quad (6.4)$ <p>The measured energy consumption in Wh for low load level is denoted as $E_{equipment}^{measured-traffic_scenario_low}$.</p> <p>The measured energy consumption in Wh for medium load level is denoted as $E_{equipment}^{measured-traffic_scenario_medium}$.</p> <p>The measured energy consumption in Wh for busy-hour load level is denoted as $E_{equipment}^{measured-traffic_scenario_busy-h}$.</p> <p>The total energy consumption for 24-hours period is calculated as following:</p> $E_{total\ equipment} = \left(E_{low} \times \frac{W_{low}}{T_{measurement\ low}} \right) + \left(E_{medium} \times \frac{W_{medium}}{T_{measurement\ medium}} \right) + \left(E_{busy\ hour} \times \frac{W_{busy\ hour}}{T_{measurement\ busy\ hour}} \right) [Wh] \quad (6.5)$ <p>Base Station Energy Efficiency (BSEP)</p> <p>The base station energy efficiency KPI is an indicator for showing how a base station in a energy efficient way is doing work in terms of delivering useful bits to the UEs served by the base station.</p> $BSEP = \frac{DV_{total}}{E_{equipment}^{total}} \left[\frac{bits}{Wh} \right] \quad (6.6)$ <p>$E_{equipment}^{total}$ is the total consumed energy during the measurement period for delivering DV_{total}</p>
Interaction with other methodologies	<p>2 of a multi-part deliverable covering Metrics and Measurement Method for Energy Efficiency of Wireless Access Network Equipment, as identified below:</p> <p>ETSI ES 202 706-1: "Power Consumption - Static Measurement Method";</p> <p>ETSI TS 102 706-2: "Energy Efficiency - dynamic measurement method".</p>
Practicability	<p>x not clear on the practicability</p>

ETSI ES 203 136 V1.2.1 (2017-10): Measurement methods for energy efficiency of router and switch equipment

Name of Initiative/ Methodology	Measurement methods for energy efficiency of router and switch equipment																																
Link	https://www.etsi.org/deliver/etsi_es/203100_203199/203136/01.02.01_60/es_203136v010201p.pdf																																
Region/ Country of implementation	International																																
Developed by	<input checked="" type="checkbox"/> Government <input type="checkbox"/> National <input checked="" type="checkbox"/> Multi-national <input type="checkbox"/> Others (Specify)		<input type="checkbox"/> Industry Association <input type="checkbox"/> National <input type="checkbox"/> Multi-national																														
Compliance	<input type="checkbox"/> Mandatory <input checked="" type="checkbox"/> Voluntary																																
Verification	<input checked="" type="checkbox"/> Self-Declaration <input type="checkbox"/> Third Party Verification																																
Scope	<input type="checkbox"/> Manufacturing <input checked="" type="checkbox"/> Use <input type="checkbox"/> End-of-Life																																
Environmental Focus	<input type="checkbox"/> GWP <input type="checkbox"/> Other environmental impacts		<input checked="" type="checkbox"/> Energy consumption																														
General Description	The Standard defines the methodology and the test conditions to measure the power consumption of router and switch equipment.																																
Sector Coverage	<p>The document is applicable to Core, edge and access routers. Ethernet switch is widely used because of fast development of Ethernet technologies and its low costs, therefore, switches in the present document refer to Ethernet switches.</p> <p>Home gateways are not included in the Standard.</p>																																
Specified Methodology	<p>Energy Efficiency Ratio of Equipment (EEER) is defined as the throughput forwarded by 1 watt, unit: Gbps/Watt. A higher EEER corresponds to a better the energy efficiency.</p> $EEER = T_i / P_i$ <p>Where:</p> $T_i = \sum_{j=1}^m B_j T_j$ <p style="text-align: center;">Table 1: Traffic load level and weight multipliers</p> <table border="1" style="margin-left: auto; margin-right: auto;"> <thead> <tr> <th rowspan="2">Equipment type</th> <th colspan="3">Traffic load level percentage of maximum load</th> <th colspan="3">Weight factor</th> </tr> <tr> <th>high</th> <th>medium</th> <th>Low</th> <th>B₁</th> <th>B₂</th> <th>B₃</th> </tr> </thead> <tbody> <tr> <td>Core equipment</td> <td>100 %</td> <td>30 %</td> <td>0 %</td> <td>0,1</td> <td>0,8</td> <td>0,1</td> </tr> <tr> <td>Edge/access</td> <td>100 %</td> <td>10 %</td> <td>0 %</td> <td>0,1</td> <td>0,8</td> <td>0,1</td> </tr> </tbody> </table> <ul style="list-style-type: none"> B_j: Weight multipliers for different traffic level, see table 1; the summation of B₁ to B₃ equal to 1. 						Equipment type	Traffic load level percentage of maximum load			Weight factor			high	medium	Low	B ₁	B ₂	B ₃	Core equipment	100 %	30 %	0 %	0,1	0,8	0,1	Edge/access	100 %	10 %	0 %	0,1	0,8	0,1
Equipment type	Traffic load level percentage of maximum load			Weight factor																													
	high	medium	Low	B ₁	B ₂	B ₃																											
Core equipment	100 %	30 %	0 %	0,1	0,8	0,1																											
Edge/access	100 %	10 %	0 %	0,1	0,8	0,1																											

	<ul style="list-style-type: none"> • T_i: Total capacity of the interfaces for a fixed configuration model (the sum of interface bandwidth). • T_i for a core functionality mode: Total weighted throughput is the sum of all interface throughputs measured in full mesh traffic topology. • T_i for an aggregation mode: The weighted sum of uplink port throughputs, measured in uplink/downlink mesh configuration. • P_i: Weighted power for different traffic loads (independent of usage model or equipment type). <p>The weighted power P_i is calculated as:</p> $P_i = \sum_{j=1}^m B_j P_j$ <p>For core equipment:</p> <ul style="list-style-type: none"> • m: The number of Traffic load levels, here 100 %, 30 %, and 0 % traffic loads are defined, so $m = 3$. • B_j: The weight multipliers of Traffic load levels for a fixed configuration model see table 1 P_j: Power of the equipment in each traffic load level see table 1 (100 %, 30 %, and 0 %), P_1 is for 100 % load, P_2 is for 30 % load, P_3 is for 0 % load. <p>For edge/access equipment:</p> <ul style="list-style-type: none"> • m: The number of Traffic load levels is 3 and they are 100 %, 10 % and 0 % traffic loads and sleep mode respectively, so $m = 3$. • B_j: The weight multipliers of Traffic load levels for a fixed configuration model, here B_1 is 0,1 for 100 % load, B_2 is 0,8 for 10 % load, B_3 is 0,1 for 0 % load, the summation of B_1 to B_3 equal to 1. • P_j: Power consumption of the equipment in each traffic load level (100 %, 10 %, and 0 %), P_1 is for 100 % load, P_2 is for 10 % load, P_3 is for 0 % load, P_4 is for sleep mode.
Interaction with other methodologies	
Practicability	x not clear on the practicability

ETSI ES 203 184 V1.1.1 (2013-03): Measurement Methods for Power Consumption in Transport Telecommunication Networks Equipment	
Name of Initiative/ Methodology	Measurement Methods for Power Consumption in Transport Telecommunication Networks Equipment
Link	https://www.etsi.org/deliver/etsi_es/203100_203199/203184/01.01.01_60/es_203184v010101p.pdf
Region/ Country of implementation	International
Developed by	<input checked="" type="checkbox"/> Government <input type="checkbox"/> Industry Association <input type="checkbox"/> National <input type="checkbox"/> National <input checked="" type="checkbox"/> Multi-national <input type="checkbox"/> Multi-national

	<input type="checkbox"/> Others (Specify)	
Compliance	<input type="checkbox"/> Mandatory	<input checked="" type="checkbox"/> Voluntary
Verification	<input checked="" type="checkbox"/> Self-Declaration	<input type="checkbox"/> Third Party Verification
Scope	<input type="checkbox"/> Manufacturing <input checked="" type="checkbox"/> Use <input type="checkbox"/> End-of-Life	
Environmental Focus	<input type="checkbox"/> GWP <input type="checkbox"/> Other environmental impacts	<input checked="" type="checkbox"/> Energy consumption
General Description	<p>This ETSI Standard (ES) defines the metric, methodology and the test conditions to evaluate the Equipment Energy Efficiency Ratio (EEER) of Transport equipments. The EEER is calculated with the same formula of the ATIS standard (ATIS-0600015.02.2009) but with the measurement conditions defined in the present document. The EEER is evaluated for a given fixed or flexible configuration. The Fixed configuration method requires that the power consumption measurement is performed on the overall system. The Flexible configuration method is applicable when the System Configuration is composed by a set of subparts whose power consumptions is previously measured and separately known. Typical subparts for Transport equipments are: Fans modules, Power supply modules, service cards (i.e. Controller and communication units), Switching units, Data interface boards, subtended subracks.</p>	
Sector Coverage	<p>Three Transport system categories are defined:</p> <ul style="list-style-type: none"> • Category A: terminal and signal conditioning equipment This category is characterized by two sides (Input and Output) as regards signal handling. The signals may be uni- or bi- directionally handled on each of the two sides of the equipment. <ul style="list-style-type: none"> ○ line OA; ○ power equalizer; ○ WDM terminal (mux/demux) • Category B: switch and ADM without tributary add/drop ports This category is characterized by switching or add/drop multiplexing functionalities and all the ports are used for network interconnection (none of the ports is used for tributary add/drop function). Equipment belonging to this category plays the role of pure transit equipment in a network. <ul style="list-style-type: none"> ○ SDH switch or ADM; ○ OTN switch or ADM; ○ WDM ROADM; ○ PT switch. • Category C: switch and ADM with tributary add/drop ports This category is characterized by switching or add/drop multiplexing functionalities and the ports are used both for network interconnection and for tributary add/drop function. Equipment belonging to this category plays the role of node in a network where part of the switched traffic is terminated towards network clients. A list of examples of equipment for category C is the same as the one provided for category B, but in case of category C the equipment includes also tributary ports. <p>Transport equipments that exploit radio or wireless interfaces (e.g. free space optics and point to point wireless/microwave transport) are out of the scope of the document.</p>	

Specified Methodology	<p>Transport Equipment Energy Efficiency Ratio (EEER) is defined as:</p> $EEER = B/P \text{ (unit: Mbps/W)}$ <p>with the following meanings:</p> <p>B Total capacity of a defined configuration (the sum of the interface data rates; unit: Mbps); for category C equipments both Network and Tributary ports shall be considered.</p> <p>P Power consumption of a defined configuration (unit: Watt).</p> <p>The higher is the EEER, the better is the energy efficiency.</p> <p>For measurement of Power consumption P, a methodology is provided to take into account equipments with both Constant Bit Rate and Variable Bit Rate (VBR) interfaces. In case of</p> <p>Variable Bit Rate (VBR) the power consumption could depend on the traffic load.</p> $P = (P_{0\%} + P_{50\%} + P_{100\%})/3$ <p>In case of transport equipment that can be configured with optical amplifiers with different gain, the following EEER can be used:</p> $EEER = B \times G/P \text{ [unit: (Mbps/W) x dB]}$ <p>G Optical Amplifier gain (unit: dB)</p> <p>In the case that Optical amplifier is not present then G = 1. In case of equipment with multiple amplifiers with different gains, the average gain will apply (e.g. G1 = 100 dB, G2 = 10 dB, then G average = 55 dB).</p>
Interaction with other methodologies	The above defined EEER is in line with the equivalent TEER defined in ATIS standard for transport equipment.
Practicability	x not clear on the practicability

ETSI EN 305 174-8 V1.1.1 (2018-01): Access, Terminals, Transmission and Multiplexing (ATTM); Broadband Deployment and Lifecycle Resource Management; Part 8: Management of end of life of ICT equipment (ICT waste/end of life)	
Name of Initiative/ Methodology	ICT waste/end of life
Link	https://www.etsi.org/deliver/etsi_en/305100_305199/30517408/01.01.01_60/en_30517408v010101p.pdf
Region/ Country of implementation	International
Developed by	<input checked="" type="checkbox"/> Government <input type="checkbox"/> Industry Association <input type="checkbox"/> National <input type="checkbox"/> National

	<input checked="" type="checkbox"/> Multi-national <input type="checkbox"/> Multi-national <input type="checkbox"/> Others (Specify)
Compliance	<input type="checkbox"/> Mandatory <input checked="" type="checkbox"/> Voluntary
Verification	<input checked="" type="checkbox"/> Self-Declaration <input type="checkbox"/> Third Party Verification
Scope	<input type="checkbox"/> Manufacturing <input checked="" type="checkbox"/> Use <input type="checkbox"/> End-of-Life
Environmental Focus	<input type="checkbox"/> GWP <input type="checkbox"/> Other environmental impacts <input checked="" type="checkbox"/> Energy consumption
General Description	<p>The treatment of obsolete ICT equipment is an important aspect of overall environmental viability of broadband deployment because:</p> <ul style="list-style-type: none"> the production of electronics devices requires the use of scarce and expensive resources; waste ICT equipment is a complex mixture of materials and components that, because of their hazardous content, can cause major environmental and health problems if not properly managed. <p>The improvement of collection, treatment and recycling of electronics at the End-of-Life (EoL) improves the environmental management of WEEE, contributes to a circular economy and enhances resource management.</p>
Sector Coverage	WEEE within ICT sites, core and access networks
Specified Methodology	<p>A set of Requirements on management of WEEE concerning supply chain, Internal organization, Extended Producer Responsibility, training, WEEE in companies network transformation, Collection Scheme and partners, Subscriber equipment, Rare resources and valorisation, Second-hand and re-use of equipment.</p> <p>The following formulas are used to calculate recycling and recovery rates:</p> $WEEE_{treated} = WEEE_{prepared\ for\ reuse} + WEEE_{reused\ by\ parts} + WEEE_{recycled} + WEEE_{recovered\ energy} + WEEE_{destroyed}$ $Reuse\ and\ recycling\ rate = \frac{WEEE_{prepared\ for\ reuse} + WEEE_{reused\ by\ parts} + WEEE_{recycled}}{WEEE_{processed}}$ $Valorisation/recovery\ rate = \frac{WEEE_{prepared\ for\ reuse} + WEEE_{reused\ by\ parts} + WEEE_{recycled} + WEEE_{recovered\ energy}}{WEEE_{processed}}$ <p>The calculation of the targets is calculated, for each category, by dividing the weight of the WEEE that enters the recovery or recycling/preparing for re-use facility, after proper treatment in accordance with Article 8(2) of WEEE 2012/19/EU Directive with regard to recovery or recycling, by the weight of all separately collected WEEE for each category, expressed as a percentage.</p>
Interaction with other methodologies	Not applicable
Practicability	x not clear on the practicability

EU: Code of Conduct on Energy Consumption of Broadband Equipment –Version 7.1

Name of Initiative/ Methodology	Code of Conduct on Energy Consumption of Broadband Equipment –Version 7.1 (2020) (Bertoldi and Lejeune 2020)	
Link	https://e3p.jrc.ec.europa.eu/publications/eu-code-conduct-energy-consumption-broadband-equipment-version-71	
Region/ Country of implementation	EU	
Developed by	<input checked="" type="checkbox"/> Government <input type="checkbox"/> Industry Association <input type="checkbox"/> National <input type="checkbox"/> National <input checked="" type="checkbox"/> Multi-national <input type="checkbox"/> Multi-national <input type="checkbox"/> Others (Specify)	
Compliance	<input type="checkbox"/> Mandatory <input checked="" type="checkbox"/> Voluntary	
Verification	<input checked="" type="checkbox"/> Self-Declaration <input type="checkbox"/> Third Party Verification	
Scope	<input type="checkbox"/> Manufacturing <input checked="" type="checkbox"/> Use <input type="checkbox"/> End-of-Life	
Environmental Focus	<input type="checkbox"/> GWP <input type="checkbox"/> Other environmental impacts	<input checked="" type="checkbox"/> Energy consumption
General Description	<p>This Code of Conduct covers equipment for broadband services both on the customer side (customer premises equipment CPE) and on the network side.</p> <p>Power consumption targets for different power modes and equipment stages are defined in the CoC. For network equipment, they have to be fulfilled for at least 90% by number of ports of the new models (introduced to the market or purchased for the first time).</p> <p>The participants of the CoC commit to co-operate with the EU Commission and Member State authorities</p> <ul style="list-style-type: none"> in an annual review of the scope of the CoC and the power consumption targets for future years. in monitoring the effectiveness of this CoC through the reporting form that is available on the homepage of the EU Standby Initiative. in ensuring that procurement specifications for broadband equipment are compliant with this CoC <p>Broadband network equipment should be designed to fulfil the environmental specifications of Class 3.1 for indoor use according to the ETSI Standard EN 300019-1-3, and where appropriate the more extended environmental conditions than Class 3.1 for use at outdoor sites. At remote sites the outdoor cabinet including the Broadband network equipment shall fulfil Class 4.1 according to the ETSI Standard EN 300019-1-4. Broadband network equipment in the outdoor cabinet should be designed taking in account the characteristics of the cabinet and the outdoor environmental condition; e.g., in case of free cooling cabinet it should be considered that the equipment inside the cabinet could operate (for short time periods) at temperature up to 60° C. If cooling is necessary, it should be preferably cooled with fresh air (fan driven, no refrigeration). The Coefficient of Performance of new site cooling systems, defined as the ratio of the effective required cooling power to the energy needed for the cooling system, should be higher than 10.</p>	

Sector Coverage	<table border="1"> <thead> <tr> <th data-bbox="488 288 1394 338">Type of network equipment covered</th> </tr> </thead> <tbody> <tr> <td data-bbox="488 338 1394 584"> <ul style="list-style-type: none"> • DSL network equipment (e.g., ADSL, ADSL2, ADSL2plus, VDSL2 and G.fast) • Combined DSL/Narrowband network equipment (e.g., MSAN where POTS interface is combined with DSL BroadBand interface) • Optical Line Terminations (OLT) for PON- and PtP-networks • Wireless Broadband network equipment (e.g., Wi-Fi access points for Hotspot application and Radio Access Network Equipment) • Cable service provider equipment (e.g. CCAP, CMTS and Edge-QAM) </td> </tr> </tbody> </table>	Type of network equipment covered	<ul style="list-style-type: none"> • DSL network equipment (e.g., ADSL, ADSL2, ADSL2plus, VDSL2 and G.fast) • Combined DSL/Narrowband network equipment (e.g., MSAN where POTS interface is combined with DSL BroadBand interface) • Optical Line Terminations (OLT) for PON- and PtP-networks • Wireless Broadband network equipment (e.g., Wi-Fi access points for Hotspot application and Radio Access Network Equipment) • Cable service provider equipment (e.g. CCAP, CMTS and Edge-QAM)
Type of network equipment covered			
<ul style="list-style-type: none"> • DSL network equipment (e.g., ADSL, ADSL2, ADSL2plus, VDSL2 and G.fast) • Combined DSL/Narrowband network equipment (e.g., MSAN where POTS interface is combined with DSL BroadBand interface) • Optical Line Terminations (OLT) for PON- and PtP-networks • Wireless Broadband network equipment (e.g., Wi-Fi access points for Hotspot application and Radio Access Network Equipment) • Cable service provider equipment (e.g. CCAP, CMTS and Edge-QAM) 			
Specified Methodology	<p>Network equipment</p> <p>Power consumption targets per port for different power modes and equipment stages are defined in the CoC. For Cable Network Equipment, power consumption per Service Group and Power Consumption per Throughput shall be determined with the metric specified in SCTE 232 2019, “Key Performance Metrics: Energy Efficiency & Functional Density of CMTS, CCAP, and Time Server Equipment”.</p>		
Interaction with other methodologies	<ul style="list-style-type: none"> • Systems powered by DC Voltage shall comply with the standard ETSI EN 300 132-2 "Environmental Engineering (EE); Power supply interface at the input to telecommunications equipment; Part 2: Operated by direct current (dc)". • The method of power measurement of equipment in line with point C.2.1, C.2.2 and C.2.3 for PON and PtP networks) shall comply with the Technical Specification ETSI ES 303 215 "Environmental Engineering (EE); Measurement Methods and limits for Power Consumption in Broadband Telecommunication Networks Equipment". • The method of power measurement for equipment in line with point C.2.4 shall comply with the Technical Specification ETSI TS 202 706-1 v1.5.1 “Environmental Engineering (EE);Metrics and measurement method for energy efficiency of wireless access network equipment Part 1: Power Consumption - Static Measurement Method” 		
Practicability	<p>The list of participants is published at the JRC website¹⁹³:</p> <ul style="list-style-type: none"> • Cisco Systems Inc. • Deutsche Telekom AG • France Telecom Group • HUAWEI Technologies CO., LTD • KPN • Nokia • OTE S.A. • Portugal Telecom, SA • Proximus • Telecom Italia • Telefonaktiebolaget LM Ericsson • Telia Company • TDC Services • Technicolor • Telefonica SA 		

¹⁹³ <https://e3p.jrc.ec.europa.eu/communities/ict-code-conduct-energy-consumption-broadband-communication-equipment> (access on 22.01.2021)

	<ul style="list-style-type: none">• ZTE corporation• TELENOR Group <p>Reports are published how many of the participants meet the requirements of the CoC for Broadband Equipment and measured values by participants are presented as percentage of the target values (last published report for 2009/2010¹⁹⁴, no update since then).</p>
--	--

¹⁹⁴ <https://e3p.jrc.ec.europa.eu/node/214> (access 22.01.2021)

Annex 9: The policy intervention logic

The methodological framework that was used to assess the impacts is based on the representation of the intervention logic of the measures and mechanisms. This logic model breaks down how a policy measure given its objectives and using a certain instrument translates into concrete actions that cause certain (short run) outputs, effects (longer run) and eventually (long run) impacts. A stylized version of this logic model is shown in Figure 39.

Figure 39: Generic intervention Logic of a policy option

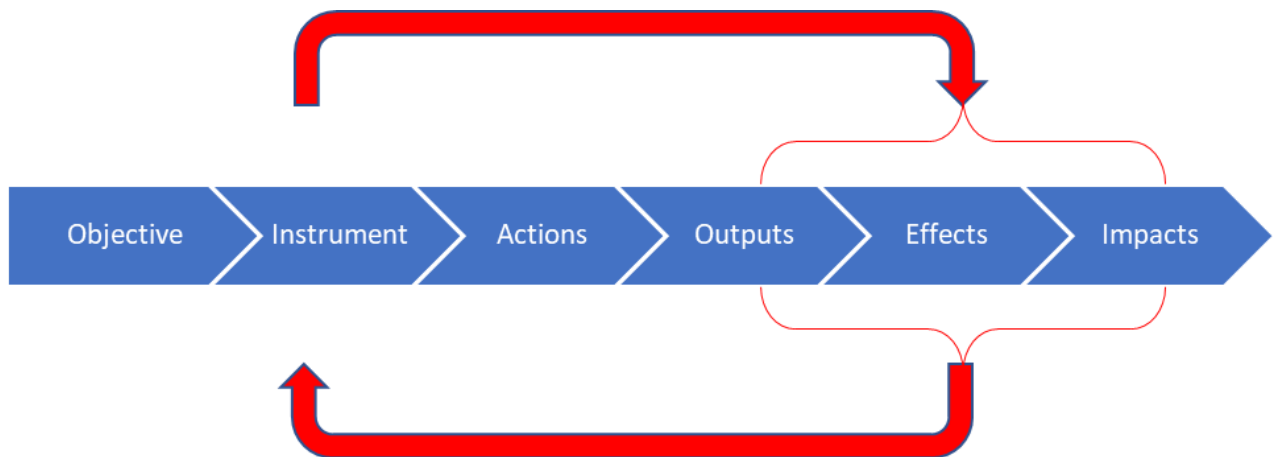

Source: IDEA Consult

The objective in the above figure is the specific objective related to the policy option itself. The instrument governs the operationalisation of the policy option, which comes down to for example the chosen set of specific rules, criteria or targets. The actions are an immediate result of the instrument. They represent how the target groups' act (directly and or indirectly) based on the implementation of the instrument (e.g. consumers, workers, enterprises, public authorities, etc.). End-users of cloud services could for example change their consumption of more energy efficient energy after a new transparency rule related to energy efficiency is implemented. Outputs are the immediate result of the actions taken. These are very concrete and direct results that take place in the short run. Effects are results in the short to medium run. Effects can be the result of a combination of actions and outputs. Impacts are results in the long run and at the level of the strategic objectives. They are less concrete in nature as they reflect the general character of the strategic objectives. They include both direct and indirect results, intended and non-intended results. Impact is the result of a combination of effects (and outputs and actions).

GETTING IN TOUCH WITH THE EU

In person

All over the European Union there are hundreds of Europe Direct information centres. You can find the address of the centre nearest you at: https://europa.eu/european-union/contact_en

On the phone or by email

Europe Direct is a service that answers your questions about the European Union. You can contact this service:

- by freephone: 00 800 6 7 8 9 10 11 (certain operators may charge for these calls),
- at the following standard number: +32 22999696 or
- by email via: https://europa.eu/european-union/contact_en

FINDING INFORMATION ABOUT THE EU

Online

Information about the European Union in all the official languages of the EU is available on the Europa website at: https://europa.eu/european-union/index_en

EU publications

You can download or order free and priced EU publications at: <https://publications.europa.eu/en/publications>. Multiple copies of free publications may be obtained by contacting Europe Direct or your local information centre (see https://europa.eu/european-union/contact_en).

EU law and related documents

For access to legal information from the EU, including all EU law since 1952 in all the official language versions, go to EUR-Lex at: <http://eur-lex.europa.eu>

Open data from the EU

The EU Open Data Portal (<http://data.europa.eu/euodp/en>) provides access to datasets from the EU. Data can be downloaded and reused for free, for both commercial and non-commercial purposes.



Publications Office
of the European Union

doi:10.2759/116715
ISBN 978-92-76-46887-5